









Mortise Locks		Description	Finish Available								Std. Pkg.
			SS	PT	SN	TM	GM	FM	CT	HG	
ML 124		Mortise Lock 60mm Backset, 3 Stroke Dead Bolt	ML 124								20
			985	985	1000	1000	1000	1000	1000	1520	
ML 110		Mortise Lock Standard	ML 110								20
			SS	PT	SN	TM	GM	FM	CT	NI	
ML 100		Mortise Lock Premium	ML 100								20
			HG		FE		SS		PT		
			1380		1380		1145		1145		

Mortise Locks	Description	Finish Available			Std. Pkg.
		NI	SS	PT	
ML 121	 NEW		ML 121 SS 1445	ML 121 PT 1445	20
ML 120	Mortise Lock (Four Pin)	ML 120 NI 1325	ML 120 SS 1325	ML 120 PT 1325	20
ML 111	Mortise Lock (Three Square Bolts)	ML 111 NI 920	ML 111 SS 920		20
ML 170	Mortise Lock Small	ML 170 NI 695			20



Mortise Locks	Description	Finish Available	Std. Pkg.
		SS	
ML110RC	 NEW	ML RC 110 SS 920	20

Mortise Locks	Description	Finish Available		Std. Pkg.
		NI	SS	
ML 160 (ECO)	Mortise 6 Lever Lock	ML 160 NI 745		20
ML 166 SS	6 Lever Mortise Dead Lock		ML 166 SS 515	20







Mortise Dead Locks	Description	Finish Available						Std. Pkg.
		NI	SS	PT	TM	GM	FM	
ML 112	Mortise Dead Lock Standard	ML 112 NI 670	ML 112 SS 670	ML 112 PT 670	ML 112 TM 670	ML 112 GM 670	ML 112 FM 670	20
ML 102	Mortise Dead Lock Premium		ML 102 SS 970	ML 102 PT 970	ML 102 HG 1215	ML 102 FE 1215		20
ML 104	Mortise Dead Lock with 60mm Backset		ML 104 SS 1035					20











Narrow Mortise Lock	Description	Finish Available		Std. Pkg.
		NI	SS	
ML 140	 Mortise Lock With latch & Hook Bolt, Backset 21mm for Sliding Door	ML 140 NI		20
		850		
ML 141	 Mortise Lock with Hook Bolt Backset 21mm for Sliding Door	ML 141 NI		20
		695		
ML 142	 Mortise Lock With Dead Bolt, Backset 21mm for Narrow Stile		ML 142 SS	20
			515	
ML 144	 Mortise Lock With Latch & Hook Bolt, Backset 21mm for Narrow Stile		ML 144 SS	20
			515	





Mortise Lock & Latch for Steel Doors	Description	Finish Available		Std. Pkg.
		SS		
ML 100D	 Mortise Dead Lock for Steel Door	ML 100 D SS		20
		900		
ML 100A	 Mortise Lock for Steel Door	ML100 ASS		20
		1145		
ML 100L	 Mortise Latch for Steel Door	ML 100 L SS		20
		810		











Mortise Lock				
Description	Finish Available			Std. Pkg.
	SS			
 ML 100 Fire Rated Upto 2 Hours	Mortise Sash Lock-Fire Rated	ML 100 SS (FR)		20
		1700		
 ML 100L Fire Rated Upto 2 Hours	Mortise Latch Lock-Fire Rated	ML 100L SS (FR)		20
		1525		
 ML 100D Fire Rated Upto 2 Hours	Mortise Dead Lock-Fire Rated	ML 100D SS (FR)		20
		1525		

Mortise Latch	Description	Finish Available					Std. Pkg.
		NI	SS	PT	HG	FE	
ML 103	 Mortise Latch Standard	ML 103					20
		635	635	635	795	795	
ML 103A	 Mortise Latch Standard	TM	GM	SN	CT	FM	20
		ML 103 A					
		635	635	635	635	635	

Euro Profile Cylinders	Description	Finish Available										Std. Pkg.
		SS	PT	SN	TM	GM	FM	CT	HG	FE		
CL 100	 Both Side Key 60mm	CL 100										20
		665	665	665	665	665	665	665	665	765	765	
CL 101	 Key and Knob 60mm	CL 101										20
		735	735	735	735	735	735	735	830	830		
CL 106	 Both Side Key 70mm	CL 106										20
		715	715	715	715	715	715	715	820	820		
CL 107	 Key and Knob 70mm	CL 107										20
		785	785	785	785	785	785	785	890	890		
CL 102	 Coin & Knob 60mm	CL 102										20
		665	665	665	665	665	665	665	765	765		
CL 108	 Coin & Knob 70mm	CL 108										20
		715	715	715	715	715	715	715	820	820		

Euro Profile Cylinders	Description	Finish Available										Std. Pkg.
		SS	PT	SN	TM	GM	FM	CT	HG	FE		
CL 200	 Both Side Key 60mm	CL 200										20
		960	960	980	980	980	980	980	1100	1100		
CL 201	 Key and Knob 60mm	CL 201										20
		1025	1025	1045	1045	1045	1045	1045	1165	1165		
CL 202	 Coin and Knob 60mm	CL 202										20
		960	960	980	980	980	980	980	1100	1100		
CL 206	 Both Side Key 70mm	CL 206										20
		1015	1015	1035	1035	1035	1035	1035	1155	1155		
CL 207	 Key and Knob 70mm	CL 207										20
		1080	1080	1100	1100	1100	1100	1100	1225	1225		
CL 208	 Coin and Knob 70mm	CL 208										20
		1015	1015	1035	1035	1035	1035	1035	1155	1155		
CL 203	 Both Side Key 80mm	CL 203										
		1100	1100	1125	1125	1125	1125	1125	1235	1235		
CL 204	 Key and Knob 80mm	CL 204										
		1165	1165	1195	1195	1195	1195	1195	1315	1315		
CL 205	 Coin and Knob 80mm	CL 205										
		1100	1100	1125	1125	1125	1125	1125	1235	1235		
CL 214	 Both Side Key 90mm	CL 214										
		1320	1320	1350	1350	1350	1350	1350	1470	1470		

Euro Profile Cylinders	Description	Finish Available										Std. Pkg.
		SS	PT	SN	TM	GM	FM	CT	HG	FE		
CL 215	 Key and Knob 90mm	CL 215										
		1390	1390	1420	1420	1420	1420	1420	1540	1540		
CL 216	 Coin and Knob 90mm	CL 216										
		1320	1320	1350	1350	1350	1350	1350	1470	1470		
CL 211	 Both Side Key 100mm	CL 211										
		1390	1390	1420	1420	1420	1420	1420	1540	1540		
CL 212	 Key and Knob 100mm	CL 212										
		1455	1455	1480	1480	1480	1480	1480	1605	1605		
CL 213	 Coin and Knob 100mm	CL 213										
		1390	1390	1420	1420	1420	1420	1420	1540	1540		

Computerized Key Cylinders	Description	Finish Available		Std. Pkg.
		SS	PT	
CL 400	 Both Side Key 60mm	CL 400		20
		715	715	
CL 401	 Key and Knob 60mm	CL 401		20
		775	775	
CL 406	 Both Side Key 70 mm	CL 406		20
		765	765	
CL 407	 Key and Knob 70mm	CL 407		20
		835	835	
CL 403	 Both Side Key 80mm	CL 403		
		1215	1215	
CL 404	 Key and Knob 80mm	CL 404		
		1265	1265	
CL 414	 Both Side Key 90mm	CL 414		
		1365	1365	
CL 415	 Key and Knob 90mm	CL 415		
		1430	1430	
CL 411	 Both Side Key 100mm	CL 411		
		1430	1430	
CL 412	 Key and Knob 100mm	CL 412		
		1490	1490	

CL-400 series cylinder will have 3 keys.







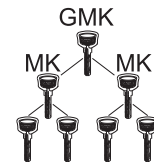

Computerized Key Cylinders	Description	Finish Available										Std. Pkg.
		SS	PT	SN	TM	GM	CT	FM	HG	FE		
CL 500	Both Side Key 60mm	CL 500										20
		800	800	830	830	830	830	830	980	980		
CL 501	Key and Knob 60mm	CL 501										20
		865	865	900	900	900	900	900	1000	1000		
CL 506	Both Side Key 70 mm	CL 506										20
		855	855	890	890	890	890	890	990	990		
CL 507	Key and Knob 70mm	CL 507										20
		920	920	960	960	960	960	960	1055	1055		
CL 503	Both Side Key 80mm	CL 503										
		1295	1295	1350	1350	1350	1350	1350	1450	1450		
CL 504	Key and Knob 80mm	CL 504										
		1355	1355	1405	1405	1405	1405	1405	1505	1505		
CL 514	Both Side Key 90mm	CL 514										
		1450	1450	1505	1505	1505	1505	1505	1615	1615		
CL 515	Key and Knob 90mm	CL 515										
		1510	1510	1575	1575	1575	1575	1575	1685	1685		
CL 511	Both Side Key 100mm	CL 511										
		1510	1510	1615	1615	1615	1615	1615	1685	1685		
CL 512	Key and Knob 90mm	CL 512										
		1580	1580	1640	1640	1640	1640	1640	1755	1755		
CL 502	Coin and Knob 60mm	CL 502										20
		800	800	830	830	830	830	830	930	930		
CL 505	Coin and Knob 80mm	CL 505										
		1295	1295	1350	1350	1350	1350	1350	1450	1450		
CL 508	Coin and Knob 70mm	CL 508										20
		855	855	890	890	890	890	890	990	990		
CL 513	Coin and Knob 100mm	CL 513										
		1510	1510	1575	1575	1575	1575	1575	1685	1685		
CL 516	Coin and Knob 90mm	CL 516										
		1450	1450	1505	1505	1505	1505	1505	1615	1615		

CL-500 series cylinder will have 5 keys.

DEFENDER 5 HIGH SECURITY EURO PROFILE CYLINDER	Description	Finish Available						Std. Pkg.
		SS	PT	SN	TM	HG	FE	
DF 200	Both Side Key 60mm	DF 200						20
		1600	1600	1745	1745	1865	1865	
DF 201	Key and Knob 60mm	DF 201						20
		1655	1655	1800	1800	1920	1920	
DF 206	Both Side Key 70mm	DF 206						20
		1655	1655	1800	1800	1920	1920	
DF 207	Key and Knob 70mm	DF 207						20
		1765	1765	1910	1910	2035	2035	
DF 203	Both Side Key 80mm	DF 203						
		1765	1765	1910	1910	2035	2035	
DF 204	Key and Knob 80mm	DF 204						
		1820	1820	1970	1970	2090	2090	

DEFENDER 5 HIGH SECURITY EURO PROFILE CYLINDER	Description	MK	MK + GMK
	Upto 20 Cylinders	221 per cylinder	221+221=442
	From 21 to 50 Cylinders	295 per cylinder	310+310=620
	From 51 and above Cylinders	410 per cylinder	410+410=820

Note: Big batches of MK can be made to order

Euro Profile Half Cylinders		Description	Finish Available	
			SS	PT
CL 200H		One Side Key 60mm	CL 200 H SS	CL 200 H PT
			840	840
CL 201H		One Side Knob 60mm	CL 201 H SS	CL 201 H PT
			840	840
CL 206H		One Side Key 70mm	CL 206 H SS	CL 206 H PT
			915	915
CL 207H		One Side Knob 70mm	CL 207 H SS	CL 207 H PT
			915	915
CL 203H		One Side Key 80mm	CL 203 H SS	CL 203 H PT
			1060	1060
CL 204H		One Side Knob 80mm	CL 204 H SS	CL 204 H PT
			1060	1060
CL 211H		One Side Key 100mm	CL 211 H SS	CL 211 H PT
			1355	1355
CL 212H		One Side Knob 100mm	CL 212 H SS	CL 212 H PT
			1355	1355

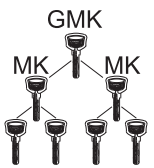
MK & GMK Charges per Euro Profile Cylinder		Description	MK	MK + GMK
	Upto 20 Cylinders	161 per cylinder	161+161=322	
	From 21 to 50 Cylinders	246 per cylinder	246+246=492	
	From 51 and above Cylinders	321 per cylinder	321+321=642	

Note: Big batches of MK can be made to order

Construction Key Cylinder

Note: Construction Key cylinder is available in Euro Profile Cylinder
Additional charges for construction key cylinder (2 keys) Rs. 205/-



Owner Key

Construction Key stop working when the Owner key is used for the very first time.



Construction Key

Separate construction Key to be used by the workers during construction.



During Construction



During Construction

Only construction key being used



After Possession



Home Possession

Owner Key used for the first time





Thereafter



Thereafter

Only Owner key is capable for Locking/Unlocking

SS 2 Ball Bearing Hinges (with screw)	Size	Code	Finish	Std. Pkg.
			SS	
	76 X 64 X 2MM	HG 1150	220	40
	102 X 76 X 2.5MM	HG 1151	360	40
	127 X 76 X 2.5MM	HG 1152	420	40
	102 X 76 X 3MM	HG 1153	390	40
	127 X 76 X 3MM	HG 1154	465	40

SS Flush Hinge (With Screw)	Size	Code	Finish
			SS
	100x37x2.5 MM (SS 304)	BHG6150A SS	310
	100x37x2.5 MM	BHG6150SS SM	245

SS 2 Ball Bearing Hinges (with screw)	Size	Code	Finish	Std. Pkg.
			SS	
	102 X 76 X 2.5MM	HG 1151 A	430	40
	127 X 76 X 2.5MM	HG 1152 A	510	40
	102 X 76 X 3MM	HG 1153 A	480	40
	127 X 76 X 3MM	HG 1154 A	575	40

Upto 2 Hour Fire Rated

Brass Tower Bolt (with screw)	Description	Finish	
		EP	SS/PT
	TR 310 - 03"	300	355
	TR 410 - 04"	480	530
	TR 610 - 06"	620	655
	TR 810 - 08"	750	785
	TR 1010 - 10"	910	945
	TR 1210 - 12"	1075	1125

Round Dia - 10mm

SS Pin Type Hinge (without screw)	Size	Code	Finish	Std. Pkg.
			SS	
	75X48X1.7MM	HG 2150	70	60
	75X48X2.5MM	HG 2150 H	100	60
	100X58X1.9MM	HG 2151	110	60
	100X61X2.5MM	HG 2151 H	145	60
	125X61X1.9MM	HG 2152	145	60
	125X65X2.5MM	HG 2152 H	185	60

Upto 2 Hour Fire Rated

SS Tower Bolt (with screw)	Description	Finish	Std. Pkg.
		SS	
	TS-410 - 04"	135	60
	TS-610 - 06"	200	60
	TS-810 - 08"	245	60
	TS-1010 - 10"	310	60
	TS-1210 - 12"	370	60
	TS-1810 - 18"	585	60



Square Shape, Dia - 10mm











SS 2 Ball Bearing Hinges (with screw)	Size	Code	Finish	Std. Pkg.
			SS	
	127 X 76 X 2.5MM	HGRC 1152 A	525	40
	102 X 76 X 3MM	HGRC 1153 A	490	40

Kadi Tala	Size	Code	Finish	Std. Pkg.
			NI	
	200 MM	KDT 200 NI	945	10
	275 MM	KDT 275 NI	1050	10

SS 2 Ball Bearing Hinges (with screw)	Size	Code	Finish	Std. Pkg.
			SS	
	102x76x3mm	HG 1253	460	40

For Steel Door
Fire Rated Upto 2 Hours

Door Accessories	Description	MRP
ME (B)	 Magic Eye Big (Brass)	410
MEF (S)	 Magic Eye Small with Flap (Brass)	340
DGBT	 Door Guard Buckel Type (Brass)	780
DS HR (SS)	 Door Stopper Floor Mounted Half Round (SS 304)	325
DS HR (Z)	 Door Stopper Floor Mounted Half Round (Zamak)	185
DB WC (22)	 Door Buffer- Wall Mounted Dia 22mm Ht. 75mm with Cover (Stainless Steel)	255
DB (22)	 Door Buffer- Wall Mounted Dia 22mm Ht. 75mm without Cover (Stainless Steel)	220
DS HT	 Door Stopper- Door Mounted Hanging Type (Brass)	355
DS HT (Z)	 Door Stopper- Door Mounted Hanging Type (Zamak)	305
MDS-CL MDS-GM	 Concealed Door Stopper (MAGNETO) NEW	735

Door Accessories	Description	MRP
DSC (M)	 Door Safety Chain- Manually (Brass & Stainless Steel)	460
BL (S)	 Sliding Bolt (Baby Latch) with Stainless Steel Lock Strip 03" (Body in Zinc)	200
BL (B)	 Sliding Bolt (Baby Latch) with SS Lock Strip 05"	325
IB 390	 Indicator Bolt	600
DDDL	 Double Door Attachment- For Dead Lock (Brass) - SS Finish	580
DDML	 Double Door Attachment- For Mortise Lock (Brass) - SS Finish	850
DDML (ML170)	 Double Door Attachment - For ML170 (Brass) - SS Finish	850
DBPVC-W	 Door Buffer 03" PVC White	40
DBRB-B	 Door Buffer 03" Rubber Black	40
MDC SS304	 Magnetic Door Catcher NEW	445

MAGNETO

MAGNETIC



**A SAFE WAY TO
KEEP DOORS OPEN**

AVOID TRIPS AND DAMAGED WALLS

