

Automatic Sliding Door Operator

DORMA XL - C®

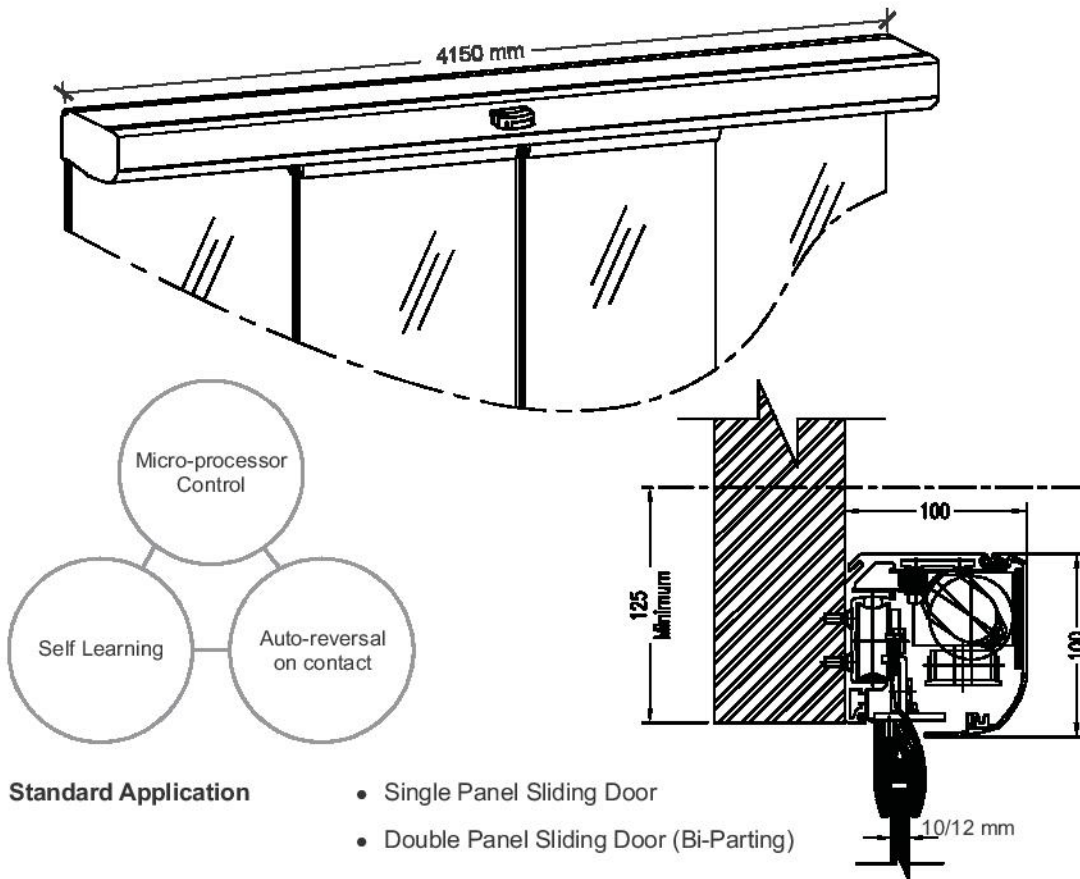

Standard Application

- Single Panel Sliding Door
- Double Panel Sliding Door (Bi-Parting)

Clear Passage Width	: Single Sliding = Min. 800 - Max. 1200 mm Double Sliding = Min. 1000 - Max. 2000 mm
Clear Passage Height	: 2400 mm (Recommended)
Max. Door Weight	: Single Sliding = 1 x 100 Kgs. Double Sliding = 2 x 85 Kgs.
Activator Options	: RADAR Sensor Pushbutton Hand held Transmitter / Receiver (Remote Control)
Program Switch Modes	: Off Automatic Permanent Open, Partial Open, Exit Only
Power Supply Data	: 230 VAC, 50/60 Hz (Mandatory UPS / Stabilized Supply)
Opening Speed	: 10 to 50 cm/sec (Incrementally Adjustable)
Closing Speed	: 10 to 40 cm/sec (Incrementally Adjustable)
Hold Open Time	: 0.5 to 30 sec (Incrementally Adjustable)
Operator Mounting	: Only Face Mounted
Standard set of Accessories	: Radar (2 Nos) Light Barrier (1 No) Program Switch with Knob (1 No)

Ordering Code : XL - C 4100
Reference Code : 9101324

Ordering Code : XL - C 4114
Reference Code : 9101289

Ordering Code : XL - C 4118
Auto sliding door without Radar
Reference Code : 9100631

Glass Mounting Application for XL - C 4114
XL - C 4100 with Back Plate,
XL - C 4115* : Special Manet Fixed - 12 mm Glass
XL - C 4116* : Special Manet Flexible - 12 mm Glass
to be used for installation

Ordering Code : XL - C 4120
Auto sliding door for Aluminium / Wooden Door
Reference Code : 9101295

*XL - C 4115 & XL - C 4116 please request for price

**Automatic
Sliding Door
Operator**

AFFORDABLE

AVAILABLE

SAFE

RELIABLE

FUNCTIONAL

61

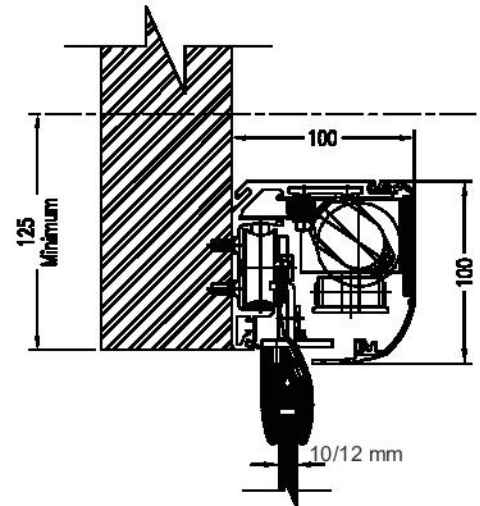
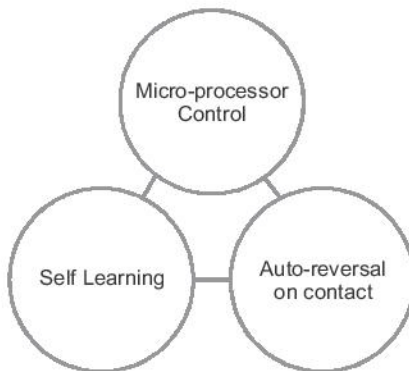
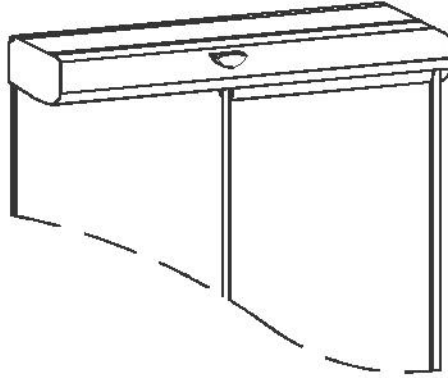
Single Door Automatic Sliding**Standard Application**

- Single Panel Sliding Door

Clear Passage Width	: Single Sliding = Min. 800 - Max. 1000 mm
Clear Passage Height	: 2400 mm (Recommended)
Max. Door Weight	: Single Sliding = 1 x 100 Kgs.
Activator Options	: RADAR Sensor Pushbutton Hand held Transmitter / Receiver (Remote Control)
Program Switch Modes	: Off Automatic Permanent Open, Partial Open, Exit Only
Power Supply Data	: 230 VAC, 50/60 Hz (Mandatory UPS / Stabilized Supply)
Opening Speed	: 10 to 50 cm/sec (Incrementally Adjustable)
Closing Speed	: 10 to 40 cm/sec (Incrementally Adjustable)
Hold Open Time	: 0.5 to 30 sec (Incrementally Adjustable)
Operator Mounting	: Only Face Mounted
Standard set of Accessories	: Radar (2 Nos) Light Barrier (1 No) Program Switch with Knob (1 No)

**Automatic
Sliding Door
Operator**

Ordering Code : XL - C 4101

Reference Code : 9101317

Automatic Swing Door Assistant (for Internal Doors only)

DORMA XL - C®

XL - C 4300

XL - C 4600

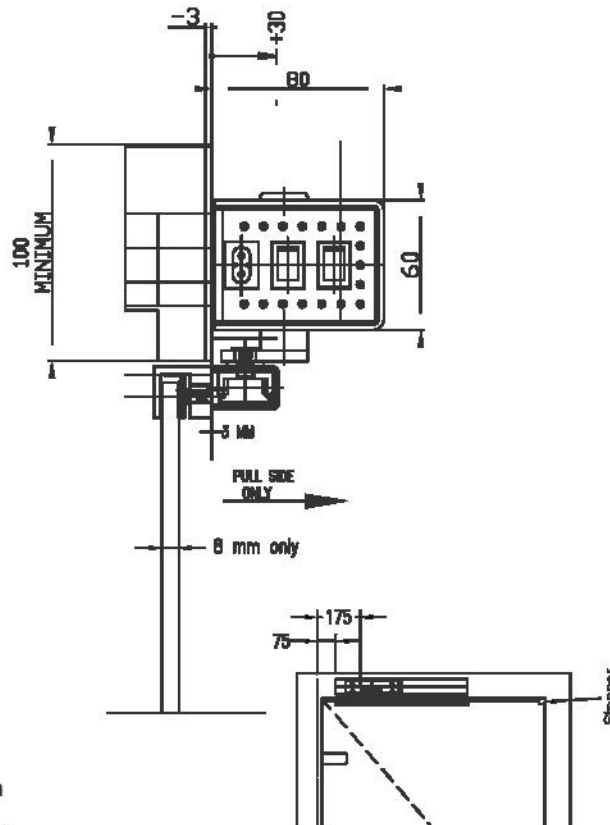
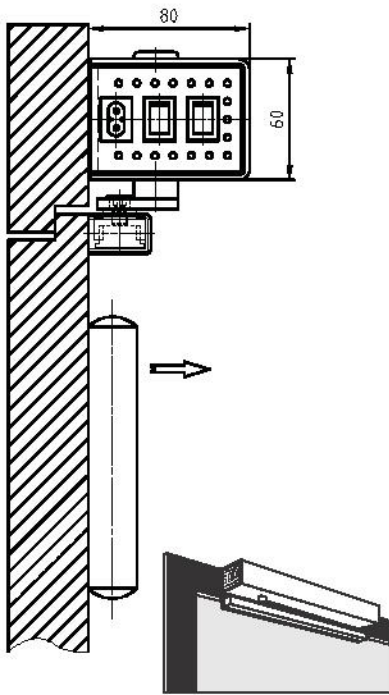

Door Leaf Width	:	≤ 1100 mm
Door Leaf Weight	:	1 x 100 Kgs.
Door Leaf Height	:	Function of Door Weight
Operator Dimension	:	Height 60 mm x Width 530 mm x Depth 80 mm
Activator Options	:	RADARS Push & Go Pushbutton Hand held Transmitter / Receiver (Remote Control)
Program Switch Modes	:	Off Power Motion Permanent Open
Power Supply Data	:	230 VAC, 50/60 Hz (Mandatory UPS / Stabilized Supply)
Opening Time (0° - 90°)	:	5 to 10 sec (Adjustable)
Closing Time (90° - 0°)	:	5 to 10 sec (Adjustable)
Hold Open Time	:	5 to 30 sec (Adjustable)
Opening Angle	:	Maximum 110°

Accessories to be ordered separately (Ref. Page No.64)

Wooden / Aluminium Door Application
for **XL - C 4300**

Frameless Glass Application
for **XL - C 4600**

XL - C 4300 with Saddle Plate and IGD Hinges

Ordering Code : **XL - C 4300**

Ordering Code : **XL - C 4600**

Reference Code : **9101326**

Reference Code : **9101340**

**Automatic
Swing Door
Assistant**

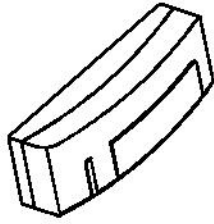

RADAR for
XL - C 4300
XL - C 4600

Ordering Code : **DORMA XL - C 4102 A**
Reference Code : **9101328**

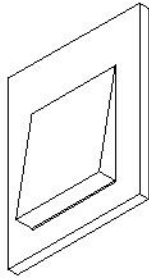

Push Button for
XL - C 4100
XL - C 4101
XL - C 4300
XL - C 4600
XL - C 4114
XL - C 4118
XL - C 4120

Ordering Code : **DORMA XL - C 4103 A**
Reference Code : **9101329**

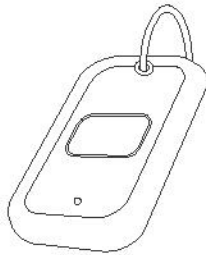

Hand held
Transmitter / Receiver
(Remote Control) for
XL - C 4100
XL - C 4101
XL - C 4300
XL - C 4600
XL - C 4114
XL - C 4118
XL - C 4120

Ordering Code : **XL - C 4104**
Reference Code : **9101339**

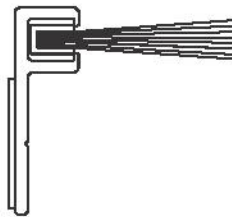

Brush profile = 3 mtrs for
XL - C 4100
XL - C 4101
XL - C 4114
XL - C 4118
XL - C 4120

Ordering Code : **XL - C 4105**
Reference Code : **9101341**

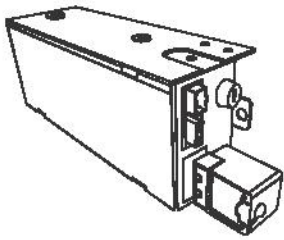

Control Unit
Assembly for
XL - C 4100
XL - C 4101
XL - C 4114
XL - C 4118
XL - C 4120

Ordering Code : XL - C 4106
Reference Code : 9101281

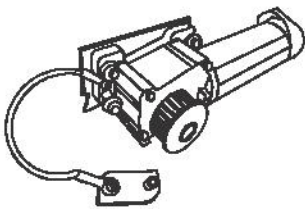

Motor Assembly for
XL - C 4100
XL - C 4101
XL - C 4114
XL - C 4118
XL - C 4120

Ordering Code : XL - C 4107
Reference Code : 9101282

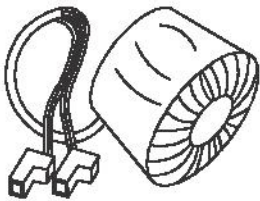

Torroidal
Transformer for
XL - C 4100
XL - C 4101
XL - C 4114
XL - C 4118
XL - C 4120

Ordering Code : XL - C 4108
Reference Code : 9101283

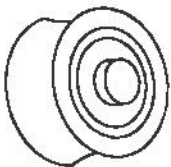

Main Roller
Assembly for
XL - C 4100
XL - C 4101
XL - C 4114
XL - C 4118
XL - C 4120

Ordering Code : XL - C 4109
Reference Code : 9101284

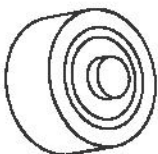

Counter Roller
Assembly for
XL - C 4100
XL - C 4101
XL - C 4114
XL - C 4118
XL - C 4120

Ordering Code : XL - C 4110
Reference Code : 9101285



Encoder Cable
450 mm for
XL - C 4100
XL - C 4101
XL - C 4114
XL - C 4118
XL - C 4120

Ordering Code : **XL - C 4111**
Reference Code : **9101286**

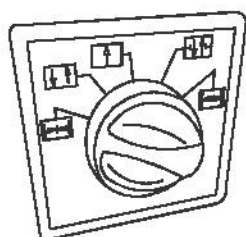

Five Position
Program Switch for
XL - C 4100
XL - C 4101
XL - C 4114
XL - C 4118
XL - C 4120

Ordering Code : **XL - C 4112**
Reference Code : **9101287**

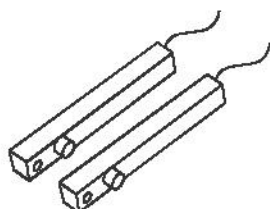

Light Barrier for
XL - C 4100
XL - C 4101
XL - C 4114
XL - C 4118
XL - C 4120

Ordering Code : **XL - C 4113**
Reference Code : **9101288**

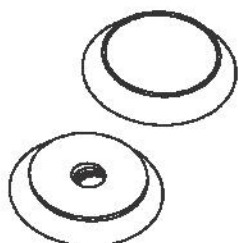

Special Manet Fixed
for 12 mm Glass

Ordering Code : **XL - C 4115**
Reference Code : **9101290**
To be used alongwith **XL - C 4114**

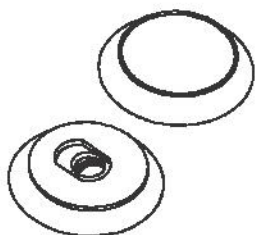

Special Manet
Flexible
for 12 mm Glass

Ordering Code : XL - C 4116
Reference Code : 9101291
To be used alongwith XL - C 4114

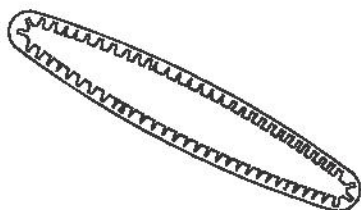

Timer Belt for
XL - C 4100
XL - C 4101
XL - C 4114
XL - C 4118
XL - C 4120

Ordering Code : XL - C 4117
Reference Code : 9101293

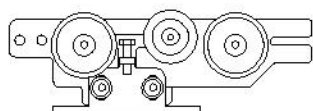

Carrier Head Assembly for
XL - C 4100
XL - C 4101
XL - C 4114
XL - C 4118
XL - C 4120

Ordering Code : XL - C 4119
Reference Code : 9101294