

Auto Hinge

Slide-on hinge

SlideOn

Technical information

Mounting options:

There are three basic mounting options.

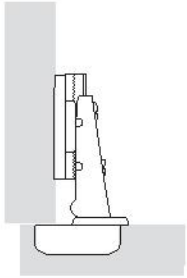

Full overlay:

This is where the door is positioned in front of the cabinet side panel, with only a small gap remaining at the side to provide the space necessary for the door to open reliably.

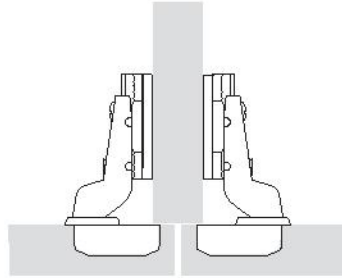

Half overlay:

This is where two doors are positioned in front of a cabinet centre panel, with the required overall reveal between them. In other words, each door has a reduced overlay. Cranked hinges are used.

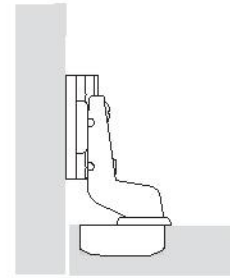

Inset:

This is where the door is positioned inside the cabinet, i.e. next to the cabinet side panel. Here too, a gap is needed so that the door can open reliably. Highly cranked hinges are used here.

Minimum door reveal:

The minimum reveal, also known as door clearance or minimum clearance, is the space required at the side for opening a door.

The amount of door clearance depends on cup distance C, door thickness and the type of hinge selected. Radii on the door edges reduce the minimum clearance.

The required minimum reveal is shown in the table for the respective hinge types.

For half-overlay applications, the total reveal selected between the doors must be at least twice the door clearance. Both doors can then be opened at the same time.

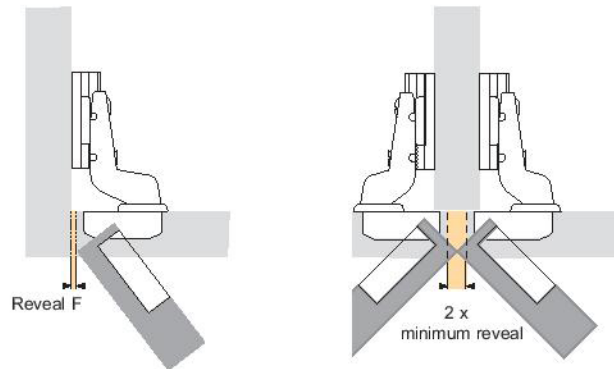

Cup distance C:

Cup distance C is the distance between door edge and the edge of the cup drilling. Resulting from the type of door movement, the maximum cup distance depends on the specific hinge type. The greater the distance selected for cup distance C, the smaller door clearance will be, i.e. the minimum reveal required.

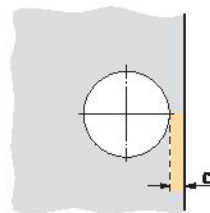

Door overlay:

Door overlay, or overlay A, is the distance by which the door extends beyond the cabinet side.

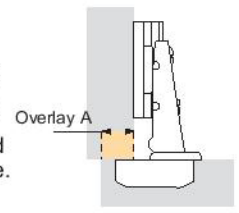

Reveal F:

The reveal is the distance from the outer edge of the door to the outer side of the cabinet in the case of full overlay applications, and the distance between two doors in the case of half-overlay applications. With the inset door, the reveal is the distance from the outer edge of the door to the inside of the cabinet side panel.

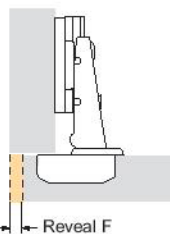

Number of hinges per door:

Door width, height and weight as well as the material quality of the door are decisive factors in determining the number of hinges required. The factors encountered in practice differ widely from case to case. For this reason, the number of hinges specified in the diagram must be understood as a guide only. If in doubt, it is recommended to carry out a trial door mounting.

For reasons of stability, the distance between the hinges must always be made as large as possible.

X = hinge spacing

(Guide values for 19 mm chipboard panels in a density of 130 kg/m

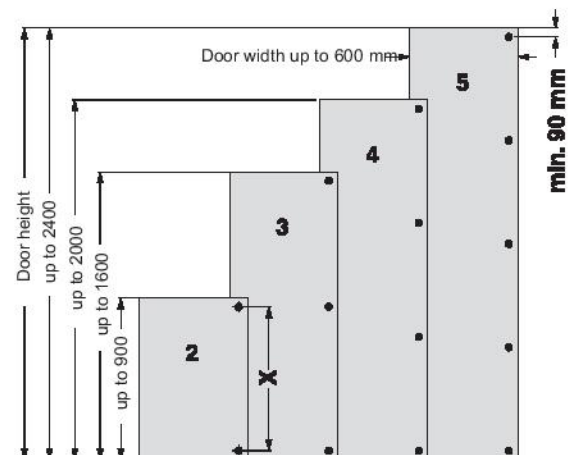

Auto Hinge

Soft Close (3 D Series)

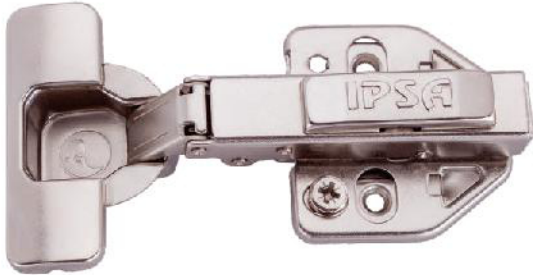

Product Code 6111



Product Code 7784



Product Code 3713

Soft Close Hinge (3 D Series)

Soft Close Hydraulic Hinges
for 19-24 mm Door Thickness

(Accessories)



Open degree: 120°

Height of hinge cup:

Diameter of Hinge cup:

Distance from door edge to the cup

Recommended door thickness

Product Code	Item Description	Size	Finish	UOM	Price (In Rs)	HSN Code	GST Tax Rate
6111	3D Hydraulic	00	SS	Per Pc	169.00	83021090	18%
7784	3D Hydraulic	08	SS	Per Pc	169.00	83021090	18%
3713	3D Hydraulic	15	SS	Per Pc	169.00	83021090	18%

T Series Hinge



Product Code 13948



Product Code 13949



Product Code 13950

T- series Hinge
Slim Hydraulic Hinges
for 19-24 mm Door Thickness

(Accessories)



Open degree: 105° degree

Height of hinge cup:

Diameter of Hinge cup: 35mm

Distance from door edge to the cup:

Recommended door thickness:

14-21 mm

Product Code	Item Description	Size	Finish	UOM	Price (In Rs)	HSN Code	GST Tax Rate
13948	Slim Hydraulic Hinge	0	SS	Per Pc	299.00	83021090	18%
13949	Slim Hydraulic Hinge	8	SS	Per Pc	299.00	83021090	18%
13950	Slim Hydraulic Hinge	15	SS	Per Pc	299.00	83021090	18%

Auto Hinge

Thick Door Hydraulic Hinge 32mm



Product Code 4450



Product Code 6805



Product Code 4329

Thick Door Hydraulic Hinge
Thick Door Hydraulic Hinge
for 19-24 mm Door Thickness

(Accessories)



- Open degree: 95 degree
- Height of hinge cup:
- Diameter of Hinge cup:
- Distance from door edge to the cup
- Recommended door thickness

Product Code	Item Description	Size	Finish	UOM	Price (In Rs)	HSN Code	GST Tax Rate
4450	Thick Door Hydraulic Hinge 32mm	0	SS	Per Pc	199.00	83021090	18%
6805	Thick Door Hydraulic Hinge 32mm	8	SS	Per Pc	199.00	83021090	18%
4329	Thick Door Hydraulic Hinge 32mm	15	SS	Per Pc	199.00	83021090	18%

Soft Close Hydraulic Hinge (X Series)



Product Code 6396



Product Code 4522



Product Code 9011

Soft Close Hydraulic Hinge 4 whole
Soft Close Hydraulic Hinges
for 19-24 mm Door Thickness

(Accessories)



- Open degree: 105°
- Height of hinge cup:
- Diameter of Hinge cup: 35 mm
- Distance from door edge to the cup
- Recommended door thickness: 14-21mm

Product Code	Item Description	Size	Finish	UOM	Price (In Rs)	HSN Code	GST Tax Rate
6396	Soft Close Hydraulic Hinge 4 Hole	0	SS	Per Pc	125.00	83021090	18%
4522	Soft Close Hydraulic Hinge 4 Hole	8	SS	Per Pc	125.00	83021090	18%
9011	Soft Close Hydraulic Hinge 4 Hole	15	SS	Per Pc	125.00	83021090	18%

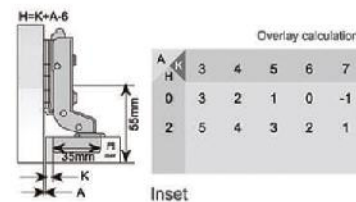
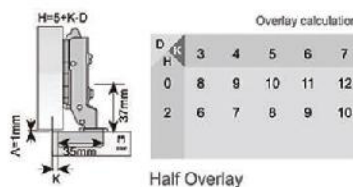
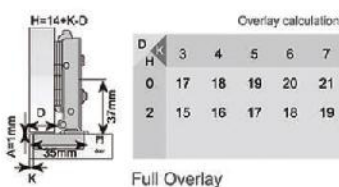

Auto Hinge

SS304 Hydraulic Hinge



Product Code 6111



Product Code 7784



Product Code 3713

SS304 Hydraulic Hinge
Soft Close Hydraulic Hinges
for 19-24 mm Door Thickness

(Accessories)

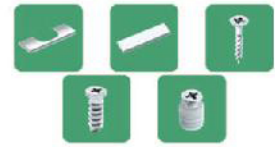

Open degree: 95 degree
Height of hinge cup:
Diameter of Hinge cup:
Distance from door edge to the cup
Recommended door thickness

Product Code	Item Description	Size	Finish	UOM	Price (In Rs)	HSN Code	GST Tax Rate
8129	Ss304 Hydraulic Hinge	0	SS	Per Pc	269.00	83021090	18%
7866	Ss304 Hydraulic Hinge	8	SS	Per Pc	269.00	83021090	18%
8709	Ss304 Hydraulic Hinge	15	SS	Per Pc	269.00	83021090	18%

SS202 Hydraulic Hinge



Product Code 12194



Product Code 12195



Product Code 12196

SS202 Hydraulic Hinge
Soft Close Hydraulic Hinges
for 19-24 mm Door Thickness

(Accessories)

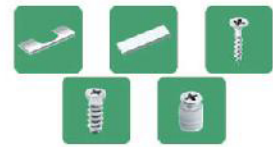

Open degree: 95 degree
Height of hinge cup:
Diameter of Hinge cup:
Distance from door edge to the cup
Recommended door thickness

Product Code	Item Description	Size	Finish	UOM	Price (In Rs)	HSN Code	GST Tax Rate
12194	SS202 Hydraulic Hinge	00	SS	Per Pc	159.00	83021090	18%
12195	SS202 Hydraulic Hinge	08	SS	Per Pc	159.00	83021090	18%
12196	SS202 Hydraulic Hinge	15	SS	Per Pc	159.00	83021090	18%

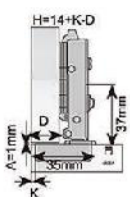

Overlay calculation

D	H	3	4	5	6	7
0	17	18	19	20	21	
2	15	16	17	18	19	

Full Overlay

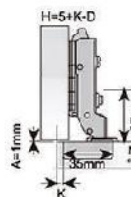

Overlay calculation

D	H	3	4	5	6	7
0	8	9	10	11	12	
2	6	7	8	9	10	

Half Overlay

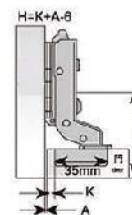

Overlay calculation

D	H	3	4	5	6	7
0	3	2	1	0	-1	
2	5	4	3	2	1	

Inset

Auto Hinge

Clip on Auto Hinge (Non-Soft Close)



Product Code 8802



Product Code 7247



Product Code 1547

Clip On Auto Hinge
Soft Close Hydraulic Hinges
for 19-24 mm Door Thickness

Open degree: 95 degree
Height of hinge cup:
Diameter of Hinge cup:
Distance from door edge to the cup
Recommended door thickness

Product Code	Item Description	Size	Finish	UOM	Price (In Rs)	HSN Code	GST Tax Rate
8802	Clip on Auto Hinge	0	SS	Per Pc	69.00	83021090	18%
7247	Clip on Auto Hinge	8	SS	Per Pc	69.00	83021090	18%
1547	Clip on Auto Hinge	15	SS	Per Pc	69.00	83021090	18%

Auto Hinge Slide on (Non-Soft Close)

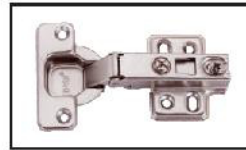
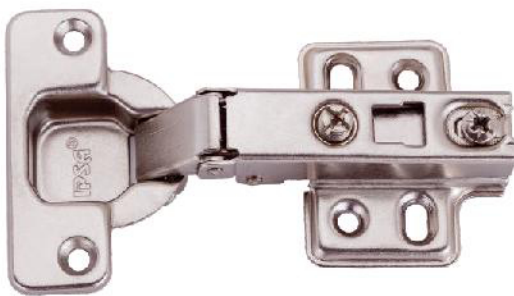

Product Code 4065



Product Code 7619

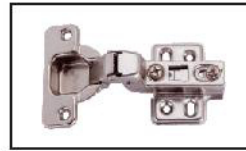

Product Code 7715

Auto Hinges Slide On
Soft Close Hydraulic Hinges
for 19-24 mm Door Thickness

(Accessories)



Open degree: 95 degree
Height of hinge cup:
Diameter of Hinge cup:
Distance from door edge to the cup
Recommended door thickness

Product Code	Item Description	Size	Finish	UOM	Price (In Rs)	HSN Code	GST Tax Rate
4065	Auto Hinge Slide on	0	SS	Per Pair	89.00	83021090	18%
7619	Auto Hinge Slide on	8	SS	Per Pair	89.00	83021090	18%
7715	Auto Hinge Slide on	15	SS	Per Pair	89.00	83021090	18%

Auto Hinge

165 Angle Hinge



Pie Corner Soft - Close Hinge



Angle- Soft Close

Product Code	Item Description	Finish	UOM	Price (In Rs)	HSN Code	GST Tax Rate
8385	Pie Corner Soft - Close Hinge	SS	Per Pc	159.00	83021090	18%
4310	Wide Angle Soft-Close Hinge	SS	Per Pc	349.00	83021090	18%

Angle Slide On Hinge

Product Code	Item Description	Finish	UOM	Price (In Rs)	HSN Code	GST Tax Rate
4232	165 Degree Angle Hinge Slide On	SS	Per Pc	179.00	83021090	18%
9020	90 Degree Angle Hinge Slide On	SS	Per Pc	89.00	83021090	18%
13951	45 Degree Angle Hinge Slide On	SS	Per Pc	89.00	83021090	18%
13952	135 Degree Angle Hinge Slide On	SS	Per Pc	149.00	83021090	18%

Auto Hinge

Glass Hydraulic Hinge



Product Code 7317



Product Code 4718



Product Code 5905

Glass Hydraulic Hinge

Hydraulic Hinges
for glass door cabinets
19-24 mm Door Thickness

Open degree: 95 degree

Height of hinge cup:

Diameter of Hinge cup:

Distance from door edge to the cup

Recommended door thickness

Product Code	Item Description	Size	Finish	UOM	Price (In Rs)	HSN Code	GST Tax Rate
7317	Glass Hydraulic Hinge	0	SS	Per Pc	169.00	83021090	18%
4718	Glass Hydraulic Hinge	8	SS	Per Pc	169.00	83021090	18%
5905	Glass Hydraulic Hinge	15	SS	Per Pc	169.00	83021090	18%

Profile Hydraulic Hinge



Product Code 5503



Product Code 8117



Product Code 4849

Profile Hydraulic Hinge
Concealed Profile
Hydraulic Hinges
for 19-24 mm Door Thickness

(Accessories)



Open degree: 95 degree

Height of hinge cup:

Diameter of Hinge cup:

Distance from door edge to the cup

Recommended door thickness

Product Code	Item Description	Size	Finish	UOM	Price (In Rs)	HSN Code	GST Tax Rate
5503	Profile Hydraulic Hinge	0	SS	Per Pc	269.00	83021090	18%
8117	Profile Hydraulic Hinge	8	SS	Per Pc	269.00	83021090	18%
4849	Profile Hydraulic Hinge	15	SS	Per Pc	269.00	83021090	18%

Drawer Sliders

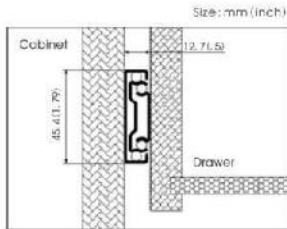

Use scope: desk drawer, cabinets, storage tank, general furniture etc.
 Features: drawer and cabinet wall can be installed separately, drawer open convenient automatic lock function can prevent the drawer slide
 Load: 100 lb (45 Kg)/group, 18 '(slide)
 Surface treatment: zinc, CED
 Material: high tension manufacture (1.2mm, 1.2mm and 1.4mm)
 Length: 10'-24 "(250 mm -600 mm)

Ball Bearing Drawer Slider

	Item Description	Size	Finish	UOM	Price (In Rs)	HSN Code	GST Tax Rate
14160	250mm 1.2x1.2x1.4	10	SS	Per Pair	350	83024200	28%
14161	300mm 1.2x1.2x1.4	12	SS	Per Pair	420	83024200	28%
14162	350mm 1.2x1.2x1.4	14	SS	Per Pair	490	83024200	28%
14163	400mm 1.2x1.2x1.4	16	SS	Per Pair	560	83024200	28%
14164	450mm 1.2x1.2x1.4	18	SS	Per Pair	630	83024200	28%
14165	500mm 1.2x1.2x1.4	20	SS	Per Pair	700	83024200	28%
14166	550mm 1.2x1.2x1.4	22	SS	Per Pair	770	83024200	28%
14167	600mm 1.2x1.2x1.4	24	SS	Per Pair	840	83024200	28%

Ball Bearing Drawer Slider Black CED

	Item Description	Size	Finish	UOM	Price (In Rs)	HSN Code	GST Tax Rate
14168	250mm 1.2x1.2x1.4	10	Black CED	Per Pair	350	83024200	28%
14169	300mm 1.2x1.2x1.4	12	Black CED	Per Pair	420	83024200	28%
14170	350mm 1.2x1.2x1.4	14	Black CED	Per Pair	490	83024200	28%
14171	400mm 1.2x1.2x1.4	16	Black CED	Per Pair	560	83024200	28%
14172	450mm 1.2x1.2x1.4	18	Black CED	Per Pair	630	83024200	28%
14173	500mm 1.2x1.2x1.4	20	Black CED	Per Pair	700	83024200	28%
14174	550mm 1.2x1.2x1.4	22	Black CED	Per Pair	770	83024200	28%
14175	600mm 1.2x1.2x1.4	24	Black CED	Per Pair	840	83024200	28%

Drawer Sliders

45 Kg Ball Bearing Drawer Slider



	Item Description	Size	Finish	UOM	Price (In Rs)	HSN Code	GST Tax Rate
6324	1.2 x 1.2 x 1.5	10	SS	Per Pair	240	83024200	18%
5511	1.2 x 1.2 x 1.5	12	SS	Per Pair	288	83024200	18%
4766	1.2 x 1.2 x 1.5	14	SS	Per Pair	336	83024200	18%
4746	1.2 x 1.2 x 1.5	16	SS	Per Pair	384	83024200	18%
5972	1.2 x 1.2 x 1.5	18	SS	Per Pair	432	83024200	18%
5439	1.2 x 1.2 x 1.5	20	SS	Per Pair	480	83024200	18%
6429	1.2 x 1.2 x 1.5	22	SS	Per Pair	528	83024200	18%
5075	1.2 x 1.2 x 1.5	24	SS	Per Pair	576	83024200	18%
6201	1.2 x 1.2 x 1.5	28	SS	Per Pair	672	83024200	18%
8723	1.2 x 1.2 x 1.5	30	SS	Per Pair	720	83024200	18%
3940	1.2 x 1.2 x 1.5	36	SS	Per Pair	864	83024200	18%

45 Kg Ball Bearing Drawer Slider 1.2 x 1.2 x 1.5



8582	1.2 x 1.2 x 1.5	10	Black CED	Per Pair	240	83024200	18%
7191	1.2 x 1.2 x 1.5	12	Black CED	Per Pair	288	83024200	18%
3745	1.2 x 1.2 x 1.5	14	Black CED	Per Pair	336	83024200	18%
8636	1.2 x 1.2 x 1.5	16	Black CED	Per Pair	384	83024200	18%
2573	1.2 x 1.2 x 1.5	18	Black CED	Per Pair	432	83024200	18%
4589	1.2 x 1.2 x 1.5	20	Black CED	Per Pair	480	83024200	18%
4514	1.2 x 1.2 x 1.5	22	Black CED	Per Pair	528	83024200	18%
7915	1.2 x 1.2 x 1.5	24	Black CED	Per Pair	576	83024200	18%
5513	1.2 x 1.2 x 1.5	28	Black CED	Per Pair	672	83024200	18%
8629	1.2 x 1.2 x 1.5	30	Black CED	Per Pair	720	83024200	18%
8637	1.2 x 1.2 x 1.5	36	Black CED	Per Pair	864	83024200	18%

Drawer Sliders

Soft close drawer slider



35 Kg Ball Bearing Drawer Slider

	Item Description	Size	Finish	UOM	Price (In Rs)	HSN Code	GST Tax Rate
1179	Ball Bearing Slider 1.0 x 1.0 x 1.2	10	SS	Per Pair	499	83024200	18%
3774	Ball Bearing Slider 1.0 x 1.0 x 1.2	12	SS	Per Pair	559	83024200	18%
3954	Ball Bearing Slider 1.0 x 1.0 x 1.2	14	SS	Per Pair	629	83024200	18%
8419	Ball Bearing Slider 1.0 x 1.0 x 1.2	16	SS	Per Pair	689	83024200	18%
4898	Ball Bearing Slider 1.0 x 1.0 x 1.2	18	SS	Per Pair	749	83024200	18%
8662	Ball Bearing Slider 1.0 x 1.0 x 1.2	20	SS	Per Pair	799	83024200	18%
5252	Ball Bearing Slider 1.0 x 1.0 x 1.2	22	SS	Per Pair	869	83024200	18%
6698	Ball Bearing Slider 1.0 x 1.0 x 1.2	24	SS	Per Pair	929	83024200	18%



Heavy Duty Slider

Heavy Duty 53mm Slider

13953	100 Kg Ball Bearing Slider 53mm Width	30	SS	Per Pair	2400	83024200	18%
13954	100 Kg Ball Bearing Slider 53 mm Width	36	SS	Per Pair	2880	83024200	18%

Drawer Sliders

Undermount Drawer Slider



Product Code	Item Description	Size	Finish	UOM	Price (In Rs)	HSN Code	GST Tax Rate
Single Extension Under Mount							
5088	Single Extension Under Mount 35 Kg	12	SS	Per Pair	619	83024200	18%
4441	Single Extension Under Mount 35 Kg	14	SS	Per Pair	749	83024200	18%
7349	Single Extension Under Mount 35 Kg	16	SS	Per Pair	829	83024200	18%
4614	Single Extension Under Mount 35 Kg	18	SS	Per Pair	939	83024200	18%
7520	Single Extension Under Mount 35 Kg	20	SS	Per Pair	1039	83024200	18%
5813	Single Extension Under Mount 35 Kg	22	SS	Per Pair	1159	83024200	18%
Full Extension Under Mount							
7239	Full Extension Under Mount 65 Kg	10	SS	Per Pair	1589	83024200	18%
8327	Full Extension Under Mount 65 Kg	12	SS	Per Pair	1629	83024200	18%
5814	Full Extension Under Mount 65 Kg	14	SS	Per Pair	1639	83024200	18%
4234	Full Extension Under Mount 65 Kg	16	SS	Per Pair	1719	83024200	18%
6765	Full Extension Under Mount 65 Kg	18	SS	Per Pair	1749	83024200	18%
8707	Full Extension Under Mount 65 Kg	20	SS	Per Pair	1819	83024200	18%
5456	Full Extension Under Mount 65 Kg	22	SS	Per Pair	1979	83024200	18%
3862	Full Extension Under Mount 65 Kg	24	SS	Per Pair	2119	83024200	18%
Push Pull Under Mount							
6338	Push Pull Under Mount 35 Kg	12	SS	Per Pair	559	83024200	18%
8267	Push Pull Under Mount 35 Kg	14	SS	Per Pair	629	83024200	18%
7822	Push Pull Under Mount 35 Kg	16	SS	Per Pair	689	83024200	18%
6776	Push Pull Under Mount 35 Kg	18	SS	Per Pair	749	83024200	18%
4096	Push Pull Under Mount 35 Kg	20	SS	Per Pair	799	83024200	18%
4810	Push Pull Under Mount 35 Kg	22	SS	Per Pair	869	83024200	18%