

DOOR HANDLES
LOCKS & SECURITY SYSTEMS
DOOR CONTROL SYSTEMS
ACCESSORIES
PATCH FITTINGS
DIGITAL DOOR LOCK
FURNITURE & KITCHEN FITTINGS

dorsët
we understand



Our Business

We are Dorset, an ISO 9001:2015, EMS 14001 : 2015, BS OHSAS 45001 : 2018 organization with over 2 decades of experience as a reputed manufacturer of architectural hardware and provider of high security locking solutions.

We combine new age aesthetics with cutting edge technology. The result is a range of path-breaking products that redefine functionality, reliability and durability.

Our collection includes door handles, door locks, lock accessories, security systems, door control devices, glass hardware, door accessories and electronic safes covering all sectors including homes, offices, establishments and industrial facilities.

Besides adding new segments to our existing range we are in the process of expanding our international presence and further enhancing our quality standards by equipping ourselves with the powers of Automation, Emerging Technologies backed by a full-fledged research unit

comprising four independent R & D cells dedicated to ushering in tomorrow, today.

At the heart of it all is our understanding of the evolving technological scenario and changing consumer needs.

We understand that in order to stay ahead we have to keep innovating to keep delighting our customers.

We have some of the best brains in the industry comprising of people who are techno - commercial having a sense of business & acumen to understand the customer needs and aspirations.

VISION

To be an enterprising, innovative and profitable global supplier of total access products for homes and workspaces, and to be an employer who understands the importance of creating value for all stakeholders.

MISSION

"Dorset Inside" We shall strive to create innovative, value-based and trustworthy products for all establishments to ensure a safe and secure living and working environment



Corporate Office: Gurugram



Manufacturing Plant: Gurugram

Product Overview



Abitare Series



Farretto Series



Premium Series



Stainless Steel Series



Pull Handle



Combo Lockset Series



Mortise Lock



Euro Profile Cylinder



Door Closer



Phantom Rim Lock



Furniture Lock



Floor Spring



Hinges & Tower Bolt



Glass Solution



Digital Door Lock



Furniture & Kitchen Fitting

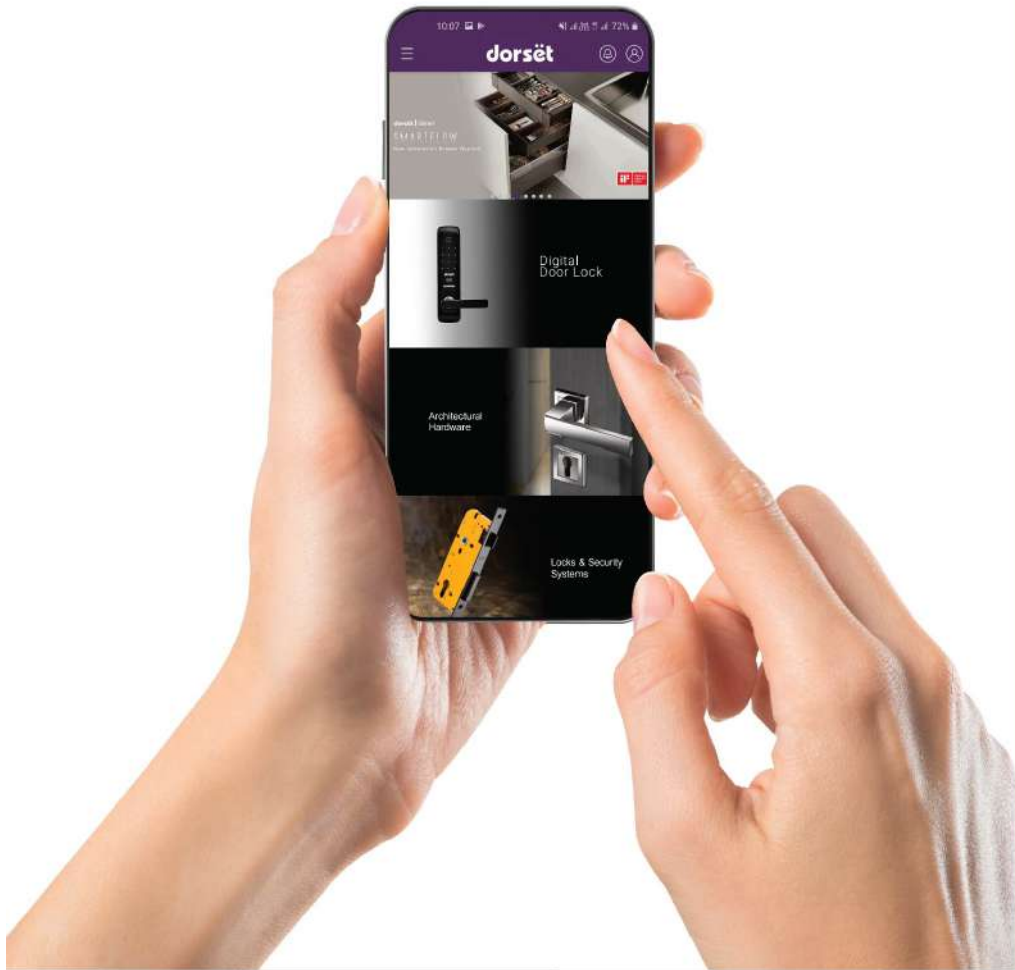

dorsët
we understand

THE APP
IS HERE TO
MAKE YOUR
LIFE EASIER...



SCAN TO DOWNLOAD
THE APP



ADVANCED FEATURES



Latest Product Brochure
and Price List



Product Installation
Videos



New Collection
Launches



Get Instant
Quotation



Latest Offers



Service Enquiry
Complaints



Where To Buy



Make Your Own
Project





dorsët
we understand

dorsët

In This COVID 19 Pandemic We Took
An Initiative
to
**Go Digital
Go Contactless!**

Scan to Download
All Product Brochures & Pricelists

www.dorsetindia.com

+91-124-4567890 response@dorsetindia.com Follow us on





dorsët
we understand

MAGNETO

DOOR CATCHER

In Technical Collaboration with



NEW



MDS-CL | MDS-GM

Magneto

Magneto's major function is to operate as a trip hazard free, fully concealed, aesthetically pleasing doorstop.

Magneto's patented striker plate design not only allows for smooth activation and deactivation, it also hold's your door firmly in place as a world leading hold-open device door-stop.

With all components concealed either within the door or the floor, Magneto is 100% trip hazard free making it ideal for commercial, hospital, hotel, retirement and general use.

WATCH PRODUCT DETAIL VIDEO ON YOUTUBE

MRP:735/-

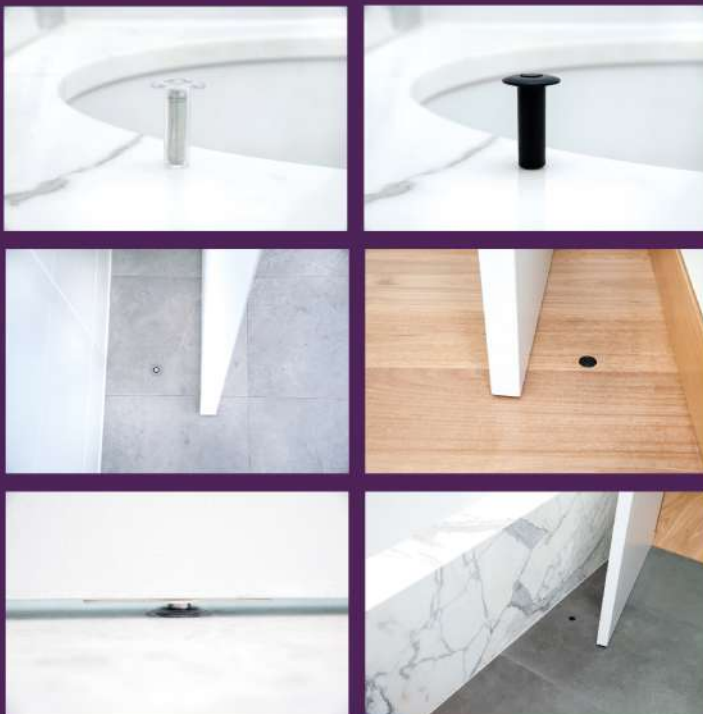

Magnet Causes Pin To Lift From The Floor Sleeve

























INDEX





1. DIGITAL LOCKS01
DIGITAL DOOR LOCK02
DIGITAL FURNITURE LOCK04
2. FIRE RATED PRODUCTS05
2. DOOR HANDLES07
ABITARE HANDLES07
FARRETTO SERIES08
PREMIUM HANDLES10
STAINLESS STEEL HANDLES12
PREMIUM PULL HANDLES14
STAINLESS STEEL PULL HANDLES16
3. LOCKS & SECURITY SYSTEMS17
MORTISE LOCK17
EURO PROFILE CYLINDER19
PHANTOM & PHANTOM FARRETTO22
KNOB SET23
FURNITURE LOCK23
COMBO LOCK SET24
4. DOOR CONTROL SYSTEMS41
5. HINGES & TOWER BOLT43
6. ACCESSORIES44
7. STRAIGHT PATCH FITTING45
8. FURNITURE & KITCHEN FITTINGS47















dorsët





Model	Variant	Code	Description	MRP
  		DG 801 MGM	Digital Lock BLE DG 801 MGM WITH CLOUD KEY 5-in-1 Access (Bio+Pin + Card+ Key) with BL & Cloud key	47150/-
  		DG 801 IGM	Digital Lock BLE DG 801 IGM WITH CLOUD KEY 5-in-1 Access (Bio+Pin + Card+ Key) with BL & Cloud key	45000/-
		DG 501 MGM	Digital Lock Mortise DG 501 MGM 4-in-1 Access (Bio + Pin + Key+ Card)	38500/-
		DG 501 IGM	Digital Lock Mortise DG 501 IGM 4-in-1 Access (Bio + Pin + Key+ Card)	36340/-
		DG 503 MGM	Digital Lock Mortise DG 503 MGM 3-in-1 Access (Bio + Pin + Key)	35000/-
		DG 503 IGM	Digital Lock Mortise DG 503 IGM 3-in-1 Access (Bio + Pin + Key)	32900/-
		DG 502 MGM	Digital Lock Mortise DG 502 MGM 3-in-1 Access (Pin + Card+ Key)	26500/-
		DG 502 IGM	Digital Lock Mortise DG 502 IGM 3-in-1 Access (Pin + Card+ Key)	24400/-
		DG 504 MGM	Digital Lock Mortise DG 504 MGM 2-in-1 Access (Pin + Key)	22500/-

Model	Variant	Code	Description	MRP
		DG 504 IGM	Digital Lock Mortise DG 504 IGM 2-in-1 Access (Pin + Key)	20400/-
 	Rim	DG 806 GM	Digital Lock RIM DG 806 GM 2-in-1 Access (Pin + Card)	9700/-
 	Rim	DG 807 GM	Digital Lock RIM DG 807 GM 1-in-1 Access (Pin)	8180/-
	Rim	DG 601 GM	Digital Lock RIM DG 601 GM 4-in-1 Access (Bio + Pin + Key + Card)	30000/-
	Rim	DG 603 GM	Digital Lock RIM DG 603 GM 3-in-1 Access (Bio + Pin + Key)	26000/-
	Rim	DG 606 GM	Digital Lock RIM DG 606 GM 2-in-1 Access (Pin + Card)	17250/-
	Rim	DG 607 GM	Digital Lock RIM DG 607 GM 1-in-1 Access (Pin)	8650/-
 	Glass Rim	DG 705 GM	Digital Lock Glass DG 705 GM 3-in-1 Access (Bio + Card + Pin)	29800/-
 	Glass Rim	DG 705 GM(R)	Digital Lock Glass DG 705 GM With RX 3-in-1 Access with remote (Bio + Card + Pin)	38000/-



	Model	Code	Description	MRP
Digital Furniture/Cabinet/Wardrobe Lock	 NEW	DG 303	Biometric Lock (Up to 20 Unique Access)	3780
	 NEW	DG 304	Biometric Lock (Up to 40 Unique Access)	2700
	 NEW	DG 305	Biometric Lock (Up to 40 Unique Access)	4140
	 NEW	DG 306	Password 4 to 15 Digits & Mechanical Key	1890

Accessories	Name	Code	Description	MRP
	Remote Kit for DG 500 Series	RE DG 50	It includes Rx Module and Remote	9199/-
	Remote Kit for DG 600 Series	RE DG 601/603	It includes Rx Module and Remote	9199/-
	Remote Kit for DG 600 Series	RE DG 606/607	It includes Rx Module and Remote	9199/-
	Remote Kit for DG 806/807	RE DG 806/807	It includes Rx Module and Remote	9199/-
	Video Door Phone Module for 500 Series	VDP DG 50	It include Rx & Tx for configuring Video Door Phone	9649/-
	Video Door Phone Module for 601/603	VDP 601/603	It include Rx & Tx for configuring Video Door Phone	9649/-
	Video Door Phone Module for 606/607	VDP 606/607	It include Rx & Tx for configuring Video Door Phone	9649/-
	Video Door Phone Module for 806/807	VDP 806/807	It include Rx & Tx for configuring Video Door Phone	9649/-
	Video Door Phone Module for 801	VDP DG 801	It include Rx & Tx for configuring Video Door Phone	9649/-
	RFID Card	DG CARD	Dorset branded RFID card	399/-
	RFID Tag	DG TAG	RFID Tag	399/-
	RFID Sticker	DG STCR	Smart RFID Sticker	299/-
	Glass Double Door Striker Plate	DG DDA	Glass Double Door Striker Plate	4299/-
	Extended Warranty Card	EWC DG	1 Year Extended warranty Card	2400/-

Stainless Steel Pull Handles (SS Grade-304)		Finish Available			
Intertek		SS			
Primo (Pair)	 <p>NEW</p> <p>Size 180mm 230mm 282mm 330mm</p> <p>Fire Rated Up to 2 Hours</p>	PR 06 P SS	PR 08 P SS	PR 10 P SS	PR 12 P SS
		1830	1945	2115	2285
Eden (Pair)	 <p>NEW</p> <p>Size 184mm 234mm 286mm 334mm</p> <p>Fire Rated Up to 2 Hours</p>	ED 06 P SS	ED 08 P SS	ED 10 P SS	ED 12 P SS
		1320	1455	1565	1710

Stainless Steel Pull Handles (SS Grade-304)		22mm dia	25.4mm dia	32mm dia	
Intertek		SS	SS	SS	
H Type (Pair)	 <p>NEW</p> <p>Fire Rated Up to 2 Hours</p>	SH 08 P SS			
		200mm	1945		
		250mm	SH 10 P SS		
			2125		
		300mm	SH 12 P SS		
			2285		
		350mm		SH 14 P SS	
				2800	
		400mm		SH 16 P SS	
				3020	
		450mm		SH 18 P SS	
				3230	
600mm			SH 24 P SS		
			4340		
750mm			SH 30 P SS		
			4970		
900mm			SH 36 P SS		
			5600		
1200mm			SH 48 P SS		
			6865		

Stainless Steel Pull Handles (SS Grade-304)		19mm dia	22mm dia		
Intertek		SS	SS		
D Type (Pair)	 <p>NEW</p> <p>Fire Rated Up to 2 Hours</p>	SD06PSS	SD06PSS		
		150mm	1245	1320	
		200mm	SD08PSS	SD08PSS	
			1385	1455	
		250mm	SD10PSS	SD10PSS	
			1500	1575	
		300mm	SD12PSS	SD12PSS	
			1645	1710	
				25.4mm dia	32mm dia
				SS	SS
		400mm	600mm	SD16PSS	SD24PSS
				2615	3640
450mm	750mm	SD18PSS	SD30PSS		
		2815	4370		
500mm	900mm	SD20PSS	SD36PSS		
		3020	5080		
600mm	1200mm		SD48PSS		
			6635		

Mortise Lock		Description	Finish Available	Std. Pkg.
Fire Rated	certifire		SS	
ML 100	 <p>NEW</p> <p>Fire Rated Up to 2 Hours</p>	Mortise Sash Lock-Fire Rated	ML 100 SS (FR)	20
			1700	
ML 100L	 <p>NEW</p> <p>Fire Rated Up to 2 Hours</p>	Mortise Latch Lock-Fire Rated	ML 100L SS (FR)	20
			1525	
ML 100D	 <p>NEW</p> <p>Fire Rated Up to 2 Hours</p>	Mortise Dead Lock-Fire Rated	ML 100D SS (FR)	20
			1525	

Stainless Steel Pull Handles (SS Grade-304)		22mm dia
Intertek		SS
SEP Type (Pair)	 <p>NEW</p> <p>Fire Rated Up to 2 Hours</p>	SEP 08 P SS
		1455
		SEP 10 P SS
		1610
300mm		SEP 12 P SS
		1760

Door Closers	Description	Weight	Finish	Std. Pkg.
			SS	
FR 80	 <p>Fire Rated Upto 2 Hours</p>	80 Kg	2810	10

SS Grade 304	SS 2 Ball Bearing Hinges (with screw)	Size	Code	Finish	Std. Pkg.
				SS	
 <p>Fire Rated Upto 2 Hours</p>	102 X 76 X 2.5MM	HG 1151 A	430	40	
	127 X 76 X 2.5MM	HG 1152 A	510	40	
	102 X 76 X 3MM	HG 1153 A	480	40	
	127 X 76 X 3MM	HG 1154 A	575	40	

For Steel Door	SS 2 Ball Bearing Hinges (with screw)	Size	Code	Finish	Std. Pkg.
				SS	
 <p>Fire Rated Upto 2 Hours</p>	102x76x3mm	HG 1253	460	40	

SS Grade 304	SS 2 Ball Bearing Hinges (with screw)	Size	Code	Finish	Std. Pkg.
				SS	
 <p>Fire Rated Upto 2 Hours</p>	127 X 76 X 2.5MM	HGRC1152 A	525	40	
	102 X 76 X 3MM	HGRC1153 A	490	40	



ML 100 FR



FR 80



TWO BALL BEARING HINGES



PIN TYPE HINGES



ML 100 L FR





















PULL HANDLE









	Finish Available				
	PT	SN	FE/HG	TM	GM
Leva	 LEV OR PT NEW	 LEV OR SN NEW	 LEV OR FE NEW	 LEV OR TM NEW	
	4200	4410	4830	4410	
Torso	 TOR OR PT NEW	 TOR OR SN NEW	 TOR OR FE NEW	 TOR OR TM NEW	
	3990	4200	4620	4200	
Globo	 GLO OR PT NEW	 GLO OR SN NEW	 GLO OR FE NEW		 GLO OR GM NEW
	3990	4410	4830		4410
Twirl	 TWR OR PT NEW	 TWR OR SN NEW	 TWR OR HG NEW	 TWR OR TM NEW	
	3990	4410	4830	4410	
Deco	 DEC OR PT NEW	 DEC OR SN NEW		 DEC OR TM NEW	
	3990	4410		4410	







All Handles in Farretto Range comes with Antimicrobial Coating







dorset

Farretto Collection (Brass) Door Handles		Finish Available			
		FETM	GMHG	HGGM	TMHG
Juliet		JL OR FETM	JL OR GMHG	JL OR HGGM	JL OR TMHG
		4135	3800	4135	3800

Farretto Collection Door Handles		Finish Available			
		FLL OR GMHG	FLL OR FEWD		FLL OR TMSN
Flo					
		3550	4125		3435

Farretto Collection (Brass) Door Handles		Finish Available				
		SN	HG	FE	GM	TM
Madonna		MA OR SN	MA OR HG			MA OR TM
		3685	4255			3685
Blob			BB OR HG	BB OR FE	BB OR GM	
			4650	4650	4650	
Dana		DA OR SN	DA OR HG	DA OR FE		
		3460	3800	3800		



Farretto Collection Door Handles		Finish Available						
		SN	GM	TM	CT	FM	HG	FE
Flap				FLA OR TM				FLA OR FE
				3435				4235
Ryder				RYD OR TM				RYD OR FE
				3090				3550
Celisa		CLS OR SN	CLS OR GM	CLS OR TM		CLS OR FM	CLS OR HG	CLS OR FE
		3435	3605	3435		3605	4205	4205
Drop		DRP OR SN		DRP OR TM	DRP OR CT	DRP OR FM	DRP OR HG	DRP OR FE
		3090		3090	3180	3180	3660	3660
Reflex		REF OR SN		REF OR TM			REF OR HG	REF OR FE
		3090		3090			3660	3660
Volex		VOE OR SN	VOE OR GM	VOE OR TM	VOE OR CT	VOE OR FM	VOE OR HG	
		2580	2690	2580	2690	2690	3095	
Vitru		VIT OR SN	VIT OR GM	VIT OR TM	VIT OR CT	VIT OR FM	VIT OR HG	
		2450	2560	2450	2560	2560	2965	
Atelier		ATL OR SN	ATL OR GM	ATL OR TM	ATL OR CT	ATL OR FM	ATL OR HG	
		2450	2560	2450	2560	2560	2965	
Siera		SIA OR SN	SIA OR GM	SIA OR TM	SIA OR CT	SIA OR FM	SIA OR HG	
		2580	2690	2580	2690	2690	3095	
Argus		ARG OR SN	ARG OR GM	ARG OR TM	ARG OR CT	ARG OR FM	ARG OR HG	
		2950	3035	2950	3035	3035	3450	
Krysta		KRY OR SN	KRY OR GM	KRY OR TM	KRY OR CT	KRY OR FM	KRY OR HG	
		2450	2560	2450	2560	2560	2965	
Optio		OPT OR SN	OPT OR GM	OPT OR TM	OPT OR CT	OPT OR FM	OPT OR HG	
		2580	2690	2580	2690	2690	3095	

Farretto Collection Door Handles		Finish Available			
Konica			KON OR FEGM	KON OR HGFE	
			4005	4125	
Speera		SPE OR GMHG	SPE OR FEWD	SPE OR HGFE	SPE OR TMWD
		3320	3320	3550	3090
Orbia			OBI OR BNGM	OBI OR HGFE	
			4065	4295	
Cornus			COR OR BNGM	COR OR HGFE	
			4175	4410	
Trase		TRA OR GMHG	TRA OR FEGM	TRA OR HGFE	TRA OR TMHG
		3890	4005	4235	3890
Pilot		PIL OR GMHG	PIL OR FEGM	PIL OR HGFE	PIL OR SNTM
		4125	4125	4350	3660
Infinito		INF OR GMHG	INF OR FEGM	INF OR HGFE	
		3780	4005	4235	













All Handles in Farretto Range comes with Antimicrobial Coating

dorset











Farrëtto Collection Door Handles		Finish Available		
		CT	SN	GM
Drop	 NEW	DRP 10 CT	DRP 10 SN	DRP 10 GM
		3295	3295	3295
Velvet	 NEW	VLV 10 CT	VLV 10 SN	VLV 10 GM
		4015	3835	4015









Farrëtto Collection Door Handles		Finish Available						
		SN	TC	TM	CT	TB	HG	FE
Velvet	 NEW	VLV OR SN	VLV OR TC	VLV OR TM	VLV OR CT	VLV OR TB	VLV OR HG	VLV OR FE
		3720	3905	3720	3905	3905	4545	4545

Farrëtto Collection Pull Handles		Finish Available		
		SN	TM/GM	HG/FE
Teesta (Pair)	 NEW W/O Rose Model	TES12PSN	TES12PTM	TES12PFE
		5145	5145	5850
Teesta (Pair)	 NEW W/O Rose Model	TES18PSN	TES18PTM	TES18PFE
		6720	6720	7455
Teesta (Pcs)	 NEW On Rose Model	TES12PRSN	TES12PRTM	TES12PRFE
		2815	2815	3255
Teesta (Pcs)	 NEW On Rose Model	TES18PRSN	TES18PRTM	TES18PRFE
		3530	3530	4025
Tero (Pair)	 NEW W/O Rose Model	TRO12PSN	TRO12PGM	TRO12PHG
		4620	4620	5460
Mohana (Pair)	 NEW W/O Rose Model	MOH12PSN	MOH12PTM	MOH12PFE
		4990	4990	5815





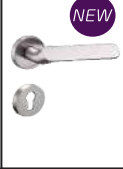

Farrëtto Collection Pull Handles		Finish Available		
		SN	TM/GM	HG/FE
Forte (Pair)	 NEW W/O Rose Model	FRT12PSN	FRT12PGM	FRT12PFE
		4200	4200	4830
Forza (Pair)	 NEW W/O Rose Model	FRZ12PSN	FRZ12PTM	FRZ12PHG
		4515	4515	5145
Forza (Pair)	 NEW W/O Rose Model	FRZ18PSN	FRZ18PTM	FRZ18PHG
		5775	5775	6615
Forza (Pcs)	 NEW On Rose Model	FRZ12PRSN	FRZ12PRTM	FRZ12PRHG
		2425	2425	2925
Forza (Pcs)	 NEW On Rose Model	FRZ18PRSN	FRZ18PRTM	FRZ18PRHG
		3035	3035	3530









Door Handles Lever		Finish Available		
		WD	SS/SC	PT/TM
Konica			KON OR SNSS	KON OR PT
			3205	3205
Speera			SPE OR SNWD	SPE OR PTTM
			2860	2860
Ryder			RYD OR SS	RYD OR PT
			2860	2860
Trase		TRA OR SNWD	TRA OR SNSS	TRA OR PTTM
		3320	3320	3320
Velvet			VLV OR SS	VLV OR PT
			3550	3550
Velvet			VLV 10 SS	VLV 10 PT
			3660	3660
Orbia		OBI OR SNWD	OBI OR SC	
		4065	3835	
Celisa			CLS OR SS	CLS OR PT
			3205	3205
Drop			DRP OR SS	DRP OR PT
			2860	2860
Drop			DRP 10 SS	DRP 10 PT
			2980	2980



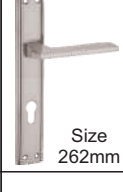

Door Handles Lever		Finish Available		
		WD	SS/SC	PT/TM
Terza			TER OR SC	TER OR PT
			3425	3425
Terza			TER 10 SC	TER 10 PT
			3720	3720
Flo			FLL OR SS	FLL OR PT
			3320	3320
Cornus		COR OR SN WD	COR OR SC	COR OR PTTM
		4175	3905	3905
Stark			STA OR SS	STA OR PT
			3975	3975
Infinito			INF OR SNSS	INF OR PTTM
			3320	3320
Pilot		PIL OR SSWD	PIL OR SNSS	
		3435	3435	
Reflex			REF OR SS	REF OR PT
			2860	2860
Edge			EDG OR SS	EDG OR PT
			3605	3605
Flap			FLA OR SN	FLA OR PT
			3320	3320

Door Handles Lever		Finish Available		
		WD	SS/SC	PT
Liberte		LIB OR WD	LIB OR SC	
		3950	3835	
Morphos	 Size 54mm		MOR OR SS	MOR OR PT
			3365	3365
Morphos	 Size 240mm		MOR 10 SS	MOR 10 PT
			3535	3595







(Brass) Door Handle Lever		Finish Available	
		SS	PT
Nika	 Size 50.4mm	NK OR SS	NK OR PT
		3455	3455
Nika	 Size 252mm	NK 10 SS	NK 10 PT
		3710	3710
Madonna	 Size 50.4mm	MA OR SS	MA OR PT
		3535	3535
Dana	 Size 50.4mm	DA OR SS	DA OR PT
		3015	3015
Dana	 Size 252mm	DA 10 SS	DA 10 PT
		3190	3190
Juliet	 Size 50mm	JL OR SS	JL OR PT
		3535	3535
Juliet	 Size 203mm	JL10 SS	JL 10 PT
		3735	3735





(Brass) Door Handle Lever		Finish Available	
		SS	PT
Zenith	 Size 50mm	ZE OR SS	ZE OR PT
		3535	3535
Zenith	 Size 240mm	ZE 10 SS	ZE 10 PT
		3735	3735
Sana	 Size 54mm	SN OR SS	SN OR PT
		3855	3855
Sana	 Size 231mm	SN 10 SS	SN 10 PT
		3855	3855
Xia	 Size 53mm	XI OR SS	XI OR PT
		4045	4045
Xia	 Size 262mm	XI 10 SS	XI 10 PT
		4045	4045
Blob		BB OR SS	BB OR PT
		4075	4075
Petal	 Size 52.3mm	PEA ORZ SC	PEA ORZ PT
		3625	3625

Door Handles Solid Stainless Steel (SS Grade-304)		19mm dia
		SS
Orius		ORS OR SS
		3585
Cella		CLA OR SS
		3365
Merina		MER OR SS
		2965
Axor		AXO OR SS
		2965

Door Handles Stainless Steel (SS Grade-304)		Finish Available
		SS
Eden	 Size 248mm	ED 10 SS
		1905
Eden	 Size 54mm	ED OR SS
		1610
Primo	 Size 248mm	PR 10 SS
		2040
Primo	 Size 54mm	PR OR SS
		1745

Door Handles Stainless Steel (SS Grade-304)		19mm dia			22mm dia		
		SS	GM	TM	SS	GM	TM
D Type	 Size 50mm	SD OR SS			SD OR SS	SD OR GM	SD OR TM
		1440			1500		
							2205
D Type	 Size 50mm NEW PVD						
						1820	
D Type	 Size 50mm NEW						
SLP	 Size 50.4mm	SLP OR SS	SLP OR GM	SLP OR TM			
		1440					
					1930		
SLP	 Size 50.4mm NEW PVD						
					1710		
U Type	 Size 50.4mm				SU OR SS		
					2040		

Door Handles Stainless Steel (SS Grade-304)		19mm dia	22mm dia
		SS	
Nika (SS)	 Size 50.4mm	NS OR SS	
		3045	
L Type	 Size 50.4mm	SL OR SS	SL OR SS
		1440	1500
C Type	 Size 51mm		SC OR SS
			1870
SO	 Size 50.4mm	SO OR SS	
		1440	
SEP	 Size 50.4mm	SEP OR SS	
		1440	
D Type	 210 X 55 X 2		SD OP SS 2
			2445
D Type	 175 X 175 X 2		SD OP SS 1
			2445











Rose (Stainless Steel)		Description	SS
Handle Rose		Rose (4pcs) Kit for Pull Handle (Available in 19 & 22 mm dia, Stainless Steel)	KT 1701 (19) KT 1702 (22)
			355
Key Rose		Key Rose Pair (Stainless Steel)	KT 1703
			180
Handle Rose		Rose (4pcs) Kit for Pull Handle (Available in 19 mm dia, Stainless Steel)	KT 1704
			355
Key Rose		Key Rose Pair (Stainless Steel)	KT 1705
			185

SAFE TOUCH









Door Handles with Anti-bacterial coating against Bacterial & Microbial Growth.











Antibacterial Coating Available Against Special Order.









Pull Handles	Finish Available	
	SS	PT
Teesta (Pair)  NEW W/O Rose Model	TES12PSS	TES12PPT
	5040	5040
Teesta (Pcs)  NEW On Rose Model	TES12PRSS	TES12PRPT
	2755	2755
Teesta (Pair)  NEW W/O Rose Model	TES18PSS	TES18PPT
	6510	6510
Teesta (Pcs)  NEW On Rose Model	TES18PRSS	TES18PRPT
	3420	3420
Tero (Pair)  NEW W/O Rose Model	TRO12PSS	TRO12PPT
	4465	4465
Mohana (Pair)  NEW W/O Rose Model	MOH12PSS	MOH12PPT
	4885	4885
Forte (Pair)  NEW W/O Rose Model	FRT12PSS	FRT12PPT
	3990	3990
Forza (Pair)  NEW W/O Rose Model	FRZ12PSS	FRZ12PPT
	4305	4305
Forza (Pcs)  NEW On Rose Model	FRZ18PRSS	FRZ18PRPT
	2925	2925
Forza (Pair)  NEW W/O Rose Model	FRZ18PSS	FRZ18PPT
	5565	5565



Pull Handles	Finish Available	
	SS	PT
Forza (Pcs)  NEW On Rose Model	FRZ12PRSS	FRZ12PRPT
	2375	2375

Pull Handles	Finish Available	
	SS/SC	PT
Atina (Pair)  Size 255mm	AI 08 PR SS	AI 08 PR PT
	4245	4245
Atina (Pcs)  Size 305mm	AI 10 PR SS	AI 10 PR PT
	2335	2335

Brass Pull Handles	Finish Available	
	SS/SC	PT
Zara (Pair)  Size 250.4mm	ZA 08 PR SS	ZA 08 PR PT
	3180	3180
Zara (Pcs)  Size 300.4mm	ZA 10 PR SS	ZA 10 PR PT
	1755	1755
Ebony (Pair)  Size 256mm	EB 08 PR SS	EB 08 PR PT
	4280	4280
Ebony (Pcs)  Size 306mm	EB 10 PR SS	EB 10 PR PT
	2540	2540
Leeba (Pcs)  Size 302mm	LE 08 PR SS	LE 08 PR PT
	2370	2370



Brass Pull Handles		Finish Available	
		SS/SC	PT
Leeba (Pcs)	 Size 357mm	LE 10 PR SS	LE 10 PR PT
		3215	3215
Delfino (Pcs)	 Size 252mm	DE 08 PR SS WC	DE 08 PR PT WC
		2460	2460
Delfino (Pcs)	 Size 307mm	DE 10 PR SS WC	DE 10 PR PT WC
		2705	2705
Xia (Pair)	 Size 252mm	XI 08 PR SS	XI 08 PR PT
		5405	5405
Xia (Pcs)	 Size 301mm	XI 10 PR SS	XI 10 PR PT
		2880	2880
Sirocco (Pcs)	 Size 293mm	SR 12 PR SS	SR 12 PR PT
		4760	4760
Versa (Pcs)	 Size 356mm	VE 13 PR SS	VE 13 PR PT
		3450	3450
Versa (Pair)	 Size 171mm	VE 06 PR SS	VE 06 PR PT
		3010	3010
Versa (Pcs)	 Size 272.5mm	VE 10 PR SS	VE 10 PR PT
		2665	2665
Sana (Pair)	 Size 256mm	SN 08 PR SS	SN 08 PR PT
		5000	5000



Brass Pull Handles		Finish Available	
		SS/SC	PT
Nika (Pair)	 Size 262mm	NK 10 PR SS	NK 10 PR PT
		6425	6425
Galaxy (Pair)	 Size 252mm	GA 06 PR SS, GA 06 PR SC	GA 06 PR PT
		4975	4975
Arch (Pcs.)	 Size 303mm	ARH 10 P SS	ARH 10 P PT
		3710	3710
Madonna (Pair)	 Size 210mm	MA 10 PR SS	MA 10 PR PT
		3640	3640
Curve (Pair) - Glass Door	 Size 329.5mm	CUR 10 PGD SC	CUR 10 PGD PT
		4650	4650
Curve (Pair)	 Size 279.5mm	CUR 08 PWD SC	CUR 08 PWD PT
		3920	3920
Curve (Pcs)	 Size 329.5mm	CUR 10 PWD SC	CUR 10 PWD PT
		2360	2360
Curve (Pair) - Glass Door	 Size 279.5mm	CUR 08 PGD SC	CUR 08 PGD PT
		4350	4350

Stainless Steel Pull Handles (SS Grade-304)		Finish Available			
		SS			
Primo (Pair)	 <p>Size 180mm 230mm 282mm 330mm</p> <p>Fire Rated Upto 2 Hours</p>	PR 06 P SS	PR 08 P SS	PR 10 P SS	PR 12 P SS
		1830	1945	2115	2285
Eden (Pair)	 <p>Size 184mm 234mm 286mm 334mm</p> <p>Fire Rated Upto 2 Hours</p>	ED 06 P SS	ED 08 P SS	ED 10 P SS	ED 12 P SS
		1320	1455	1565	1710

Stainless Steel Pull Handles (SS Grade-304)		19mm dia		22mm dia			
		SS	SS	GM	TM		
D Type (Pair)	 <p>NEW</p> <p>PVD</p> <p>Fire Rated Upto 2 Hours</p>	150mm	SD06PSS	SD06PSS			
			1245	1320			
			200mm	SD08PSS	SD08PSS	SD08PGM	SD08PTM
				1385	1455	1945	2250
			250mm	SD10PSS	SD10PSS	SD10PGM	SD10PTM
				1500	1575	2170	2520
		300mm	SD12PSS	SD12PSS	SD12PGM	SD12PTM	
			1645	1710	2425	2815	
				25.4mm dia		32mm dia	
				SS	GM	TM	SS
		400mm	SD16PSS	SD16PGM	SD16PTM		SD24PSS
			2615	3560	4130	600mm	3640
450mm	SD18PSS			750mm	SD30PSS		
	2815				4370		
500mm	SD20PSS			900mm	SD36PSS		
	3020				5080		
600mm				1200mm	SD48PSS		
					6635		

Stainless Steel Pull Handles (SS Grade-304)		22mm dia			25.4mm dia			32mm dia	
		SS	GM	TM	SS	GM	TM	SS	
H Type (Pair)	 <p>NEW</p> <p>PVD</p> <p>NEW</p> <p>Fire Rated Upto 2 Hours</p>	200mm	SH 08 P SS	SH 08 P GM	SH 08 P TM				
			1945	2425	2815				
			250mm	SH 10 P SS	SH 10 P GM	SH 10 P TM			
		2125		2725	3160				
		300mm	SH 12 P SS	SH 12 P GM	SH 12 P TM				
			2285	3005	3485				
		350mm				SH 14 P SS	SH 14 P GM	SH 14 P TM	
						2800	3750	4380	
		400mm				SH 16 P SS	SH 16 P GM	SH 16 P TM	
						3020	3975	4615	
		450mm				SH 18 P SS			
						3230			
600mm							SH 24 P SS		
							4340		
750mm							SH 30 P SS		
							4970		
900mm							SH 36 P SS		
							5600		
1200mm							SH 48 P SS		
							6865		

Stainless Steel Pull Handles (SS Grade-304)		22mm dia		
		SS		
SEP Type (Pair)	 <p>Fire Rated Upto 2 Hours</p>	200mm	SEP 08 P SS	
			1455	
			250mm	SEP 10 P SS
1610				
SOP Type (Pair)		200mm	SO 08 P SS	
			1455	
		250mm	SO 10 P SS	
1565				
U Type (Pair)		200mm	SU 08 P SS	
			2105	
		250mm	SU 10 P SS	
2265				
300mm	SU 12 P SS			
	2415			





Mortise Locks		Description	Finish Available								Std. Pkg.
			SS	PT	SN	TM	GM	FM	CT	HG	
ML 124		Mortise Lock 60mm Backset, 3 Stroke Dead Bolt	ML 124								20
			985	985	1000	1000	1000	1000	1000	1520	
ML 110		Mortise Lock Standard	ML 110								20
			SS	PT	SN	TM	GM	FM	CT	NI	
ML 100		Mortise Lock Premium	ML 100								20
			HG		FE		SS		PT		
			1380		1380		1145		1145		

Mortise Locks	Description	Finish Available			Std. Pkg.
		NI	SS	PT	
ML 121	Mortise Lock 60mm Backset Heavy Duty 4 Pin	ML 121 SS	ML 121 PT	20	
		1445	1445		
ML 120	Mortise Lock (Four Pin)	ML 120 NI	ML 120 SS	20	
		1325	1325		
ML 111	Mortise Lock (Three Square Bolts)	ML 111 NI	ML 111 SS	20	
		920	920		
ML 170	Mortise Lock Small	ML 170 NI		20	
		695			



Mortise Locks	Description	Finish Available	Std. Pkg.
		SS	
ML110RC	Round Corner Mortise Lock (Standard)	ML RC 110 SS	20
		920	



Mortise Locks	Description	Finish Available		Std. Pkg.
		NI	SS	
ML 160 (ECO)	Mortise 6 Lever Lock	ML 160 NI		20
		745		
ML 166 SS	6 Lever Mortise Dead Lock		ML 166 SS	20
			515	







Mortise Dead Locks	Description	Finish Available						Std. Pkg.
		NI	SS	PT	TM	GM	FM	
ML 112	Mortise Dead Lock Standard	ML 112 NI	ML 112 SS	ML 112 PT	ML 112 TM	ML 112 GM	ML 112 FM	20
		670	670	670	670	670	670	
ML 102	Mortise Dead Lock Premium		SS	PT	HG	FE		20
			ML 102 SS	ML 102 PT	ML 102 HG	ML 102 FE		
			970	970	1215	1215		
ML 104	Mortise Dead Lock with 60mm Backset		SS					20
			ML 104 SS					
			1035					











Narrow Mortise Lock		Description	Finish Available		Std. Pkg.
			NI	SS	
ML 140		Mortise Lock With latch & Hook Bolt, Backset 21mm for Sliding Door	ML 140 NI		20
			850		
ML 141		Mortise Lock with Hook Bolt Backset 21mm for Sliding Door	ML 141 NI		20
			695		
ML 142		Mortise Lock With Dead Bolt, Backset 21mm for Narrow Stile		ML 142 SS	20
				515	
ML 144		Mortise Lock With Latch & Hook Bolt, Backset 21mm for Narrow Stile		ML 144 SS	20
				515	





Mortise Lock & Latch for Steel Doors		Description	Finish Available		Std. Pkg.
			SS		
ML 100D		Mortise Dead Lock for Steel Door	ML 100 D SS		20
			900		
ML 100A		Mortise Lock for Steel Door	ML100 A SS		20
			1145		
ML 100L		Mortise Latch for Steel Door	ML 100 L SS		20
			810		











Mortise Lock						
		Description	Finish Available			Std. Pkg.
			SS			
ML 100		Mortise Sash Lock-Fire Rated	ML 100 SS (FR)		20	
			1700			
ML 100L		Mortise Latch Lock-Fire Rated	ML 100L SS (FR)		20	
			1525			
ML 100D		Mortise Dead Lock-Fire Rated	ML 100D SS (FR)		20	
			1525			

Mortise Latch		Description	Finish Available					Std. Pkg.
			NI	SS	PT	HG	FE	
ML 103		Mortise Latch Standard	ML 103					20
			635	635	635	795	795	
ML 103A		Mortise Latch Standard	TM	GM	SN	CT	FM	20
			ML 103 A					
			635	635	635	635	635	

Euro Profile Cylinders	Description	Finish Available										Std. Pkg.
		SS	PT	SN	TM	GM	FM	CT	HG	FE		
CL 100	 Both Side Key 60mm	CL 100										20
		665	665	665	665	665	665	665	665	765	765	
CL 101	 Key and Knob 60mm	CL 101										20
		735	735	735	735	735	735	735	735	830	830	
CL 106	 Both Side Key 70mm	CL 106										20
		715	715	715	715	715	715	715	715	820	820	
CL 107	 Key and Knob 70mm	CL 107										20
		785	785	785	785	785	785	785	785	890	890	
CL 102	 Coin & Knob 60mm	CL 102										20
		665	665	665	665	665	665	665	665	765	765	
CL 108	 Coin & Knob 70mm	CL 108										20
		715	715	715	715	715	715	715	715	820	820	

Euro Profile Cylinders	Description	Finish Available										Std. Pkg.
		SS	PT	SN	TM	GM	FM	CT	HG	FE		
CL 200	 Both Side Key 60mm	CL 200										20
		960	960	980	980	980	980	980	980	1100	1100	
CL 201	 Key and Knob 60mm	CL 201										20
		1025	1025	1045	1045	1045	1045	1045	1045	1165	1165	
CL 202	 Coin and Knob 60mm	CL 202										20
		960	960	980	980	980	980	980	980	1100	1100	
CL 206	 Both Side Key 70mm	CL 206										20
		1015	1015	1035	1035	1035	1035	1035	1035	1155	1155	
CL 207	 Key and Knob 70mm	CL 207										20
		1080	1080	1100	1100	1100	1100	1100	1100	1225	1225	
CL 208	 Coin and Knob 70mm	CL 208										20
		1015	1015	1035	1035	1035	1035	1035	1035	1155	1155	
CL 203	 Both Side Key 80mm	CL 203										
		1100	1100	1125	1125	1125	1125	1125	1125	1235	1235	
CL 204	 Key and Knob 80mm	CL 204										
		1165	1165	1195	1195	1195	1195	1195	1195	1315	1315	
CL 205	 Coin and Knob 80mm	CL 205										
		1100	1100	1125	1125	1125	1125	1125	1125	1235	1235	
CL 214	 Both Side Key 90mm	CL 214										
		1320	1320	1350	1350	1350	1350	1350	1350	1470	1470	

Euro Profile Cylinders	Description	Finish Available										Std. Pkg.
		SS	PT	SN	TM	GM	FM	CT	HG	FE		
CL 215	 Key and Knob 90mm	CL 215										
		1390	1390	1420	1420	1420	1420	1420	1420	1540	1540	
CL 216	 Coin and Knob 90mm	CL 216										
		1320	1320	1350	1350	1350	1350	1350	1350	1470	1470	
CL 211	 Both Side Key 100mm	CL 211										
		1390	1390	1420	1420	1420	1420	1420	1420	1540	1540	
CL 212	 Key and Knob 100mm	CL 212										
		1455	1455	1480	1480	1480	1480	1480	1480	1605	1605	
CL 213	 Coin and Knob 100mm	CL 213										
		1390	1390	1420	1420	1420	1420	1420	1420	1540	1540	

Computerized Key Cylinders	Description	Finish Available		Std. Pkg.
		SS	PT	
CL 400	 Both Side Key 60mm	CL 400		20
		715	715	
CL 401	 Key and Knob 60mm	CL 401		20
		775	775	
CL 406	 Both Side Key 70 mm	CL 406		20
		765	765	
CL 407	 Key and Knob 70mm	CL 407		20
		835	835	
CL 403	 Both Side Key 80mm	CL 403		
		1215	1215	
CL 404	 Key and Knob 80mm	CL 404		
		1265	1265	
CL 414	 Both Side Key 90mm	CL 414		
		1365	1365	
CL 415	 Key and Knob 90mm	CL 415		
		1430	1430	
CL 411	 Both Side Key 100mm	CL 411		
		1430	1430	
CL 412	 Key and Knob 100mm	CL 412		
		1490	1490	

CL-400 series cylinder will have 3 keys.

Computerized Key Cylinders	HYBRID TWO TRACK TECHNOLOGY KEY	Description	Finish Available									Std. Pkg.
			SS	PT	SN	TM	GM	CT	FM	HG	FE	
CL 500		Both Side Key 60mm	CL 500									20
			800	800	830	830	830	830	830	980	980	
CL 501		Key and Knob 60mm	CL 501									20
			865	865	900	900	900	900	900	1000	1000	
CL 506		Both Side Key 70 mm	CL 506									20
			855	855	890	890	890	890	890	990	990	
CL 507		Key and Knob 70mm	CL 507									20
			920	920	960	960	960	960	960	1055	1055	
CL 503		Both Side Key 80mm	CL 503									
			1295	1295	1350	1350	1350	1350	1350	1450	1450	
CL 504		Key and Knob 80mm	CL 504									
			1355	1355	1405	1405	1405	1405	1405	1505	1505	
CL 514		Both Side Key 90mm	CL 514									
			1450	1450	1505	1505	1505	1505	1505	1615	1615	
CL 515		Key and Knob 90mm	CL 515									
			1510	1510	1575	1575	1575	1575	1575	1685	1685	
CL 511		Both Side Key 100mm	CL 511									
			1510	1510	1615	1615	1615	1615	1615	1685	1685	
CL 512		Key and Knob 90mm	CL 512									
			1580	1580	1640	1640	1640	1640	1640	1755	1755	
CL 502		Coin and Knob 60mm	CL 502									20
			800	800	830	830	830	830	830	930	930	
CL 505		Coin and Knob 80mm	CL 505									
			1295	1295	1350	1350	1350	1350	1350	1450	1450	
CL 508		Coin and Knob 70mm	CL 508									20
			855	855	890	890	890	890	890	990	990	
CL 513		Coin and Knob 100mm	CL 513									
			1510	1510	1575	1575	1575	1575	1575	1685	1685	
CL 516		Coin and Knob 90mm	CL 516									
			1450	1450	1505	1505	1505	1505	1505	1615	1615	

CL-500 series cylinder will have 5 keys.

DEFENDER 5 HIGH SECURITY EURO PROFILE CYLINDER	Description	Finish Available						Std. Pkg.
		SS	PT	SN	TM	HG	FE	
DF 200	Both Side Key 60mm	DF 200						20
		1600	1600	1745	1745	1865	1865	
DF 201	Key and Knob 60mm	DF 201						20
		1655	1655	1800	1800	1920	1920	
DF 206	Both Side Key 70mm	DF 206						20
		1655	1655	1800	1800	1920	1920	
DF 207	Key and Knob 70mm	DF 207						20
		1765	1765	1910	1910	2035	2035	
DF 203	Both Side Key 80mm	DF 203						
		1765	1765	1910	1910	2035	2035	
DF 204	Key and Knob 80mm	DF 204						
		1820	1820	1970	1970	2090	2090	

DEFENDER 5 HIGH SECURITY EURO PROFILE CYLINDER	Description	MK	MK + GMK
	Upto 20 Cylinders	221 per cylinder	221+221=442
	From 21 to 50 Cylinders	295 per cylinder	310+310=620
	From 51 and above Cylinders	410 per cylinder	410+410=820

Note: Big batches of MK can be made to order

Euro Profile Half Cylinders	Description	Finish Available	
		SS	PT
CL 200H	One Side Key 60mm	CL 200 H SS	CL 200 H PT
		840	840
CL 201H	One Side Knob 60mm	CL 201 H SS	CL 201 H PT
		840	840
CL 206H	One Side Key 70mm	CL 206 H SS	CL 206 H PT
		915	915
CL 207H	One Side Knob 70mm	CL 207 H SS	CL 207 H PT
		915	915
CL 203H	One Side Key 80mm	CL 203 H SS	CL 203 H PT
		1060	1060
CL 204H	One Side Knob 80mm	CL 204 H SS	CL 204 H PT
		1060	1060
CL 211H	One Side Key 100mm	CL 211 H SS	CL 211 H PT
		1355	1355
CL 212H	One Side Knob 100mm	CL 212 H SS	CL 212 H PT
		1355	1355

MK & GMK Charges per Euro Profile Cylinder	Description	MK	MK + GMK
	Upto 20 Cylinders	161 per cylinder	161+161=322
	From 21 to 50 Cylinders	246 per cylinder	246+246=492
	From 51 and above Cylinders	321 per cylinder	321+321=642

Note: Big batches of MK can be made to order

Construction Key Cylinder

Note: Construction Key cylinder is available in Euro Profile Cylinder
Additional charges for construction key cylinder (2 keys) Rs. 205/-



Owner Key

Construction Key stop working when the Owner key is used for the very first time.



Construction Key

Separate construction Key to be used by the workers during construction.



During Construction



During Construction

Only construction key being used



After Possesion



Home Possesion

Owner Key used for the first time



Thereafter

Only Owner key is capable for Locking/Unlocking

PHANTOM ...Your Guardian		Product Name & Description	IV	NS	MPT
PHA 300		Trio Lock Both Side Key Model	2285	3555	3645
PHA 301		Trio Lock Key and Knob Model	2120	3220	3300
PHA 302		Trio Lock Dead Bolt Both Side Key Model	2465	3315	3410
PHA 303		Trio Lock Dead Bolt Key and Knob Model	2010	2995	3090
PHA 103		Dead Lock Key and Knob Model	1650	1775	1870
PHA 102		Dead Lock Both Side Key Model	1820	1960	2055
PHA 100		Night Latch Both Side Key Model For Inside Opening	2355	2530	2620
PHA 101		Night Latch Key and Knob Model For Inside Opening	1540	2325	2425

PHANTOM ...Your Guardian		Product Name & Description	IV (O/S)	NS (O/S)	MPT (O/S)
PHA 100		Night Latch Both Side Key Model For Out side Opening	2355	2530	2620
PHA 101		Night Latch Key and Knob Model For Out side Opening	1540	2325	2425

SMART SERIES		Product Name & Description	IV	NS	MPT
SM 100		Night Latch Both Side Key Model For Inside Opening	1445	1560	1655
SM 101		Night Latch Key and Knob Model For Inside Opening	1410	1485	1575
SM 102		Dead Lock Both Side Key Model	1275	1375	1375
SM 103		Dead Lock Key and Knob Model	1055	1130	1130

SMART SERIES		Product Name & Description	IV (O/S)	NS (O/S)	MPT (O/S)
SM 100		Night Latch Both Side Key Model For Out side Opening	1445	1560	1655
SM 101		Night Latch Key and Knob Model For Out side Opening	1410	1485	1575



PHANTOM ...Your Guardian		Product Name & Description	IV	NS	MPT
PHA 200		Verti Lock Both Side Key Model	2260	3055	3155
PHA 201		Verti Lock Key and Knob Model	1830	2680	2775

Farrëtto
Collection

PHANTOM ...Your Guardian		Product Name & Description	FM	TM	SN	HG-FE
PHA 300		Trio Lock Both Side Key Model	3645	3645	3645	NA
PHA 301		Trio Lock Key and Knob Model	3300	3300	3300	3715
PHA 302		Trio Lock Dead Bolt Both Side Key Model	3410	3410	3410	NA
PHA 303		Trio Lock Dead Bolt Key and Knob Model	3090	3090	3090	3300

ZOD (Rim Pull Handle)		Description	SC	MPT
ZOD			ZOD00PR SC	ZOD00PR PT
		Rim Pull Handle suitable with Phantom series	1025	1025
ZOD			ZOD0000 SC	ZOD0000 PT
		Rim Pull Handle suitable with Phantom series	1025	1025

Suitable For : Main Entrance Doors & 30-60 mm thick Doors
Applicable for Inside/Outside door opening



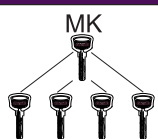



Knob Set	Description	Finish Available		Std. Pkg.
		S/S	A/B	
ETTO SM (SS)	 Entrance Smart	855		30
PRTO SM (SS)	 Privacy Smart	800		30
ETTO	 Entrance	965	1030	24
PRTO	 Privacy	895	960	24



MK Charges per Knob Set	Description	MK
	Upto 24 Cylinders	135 extra per lock



Note: Master Key Only Available in SS Finish.

Multipurpose Locks	Description	Finish Available		Std. Pkg.
		NI/SS		
MP 390 (NI)	 Multipurpose Lock	125		120
MP 330 (NI)	 Multipurpose Lock Eco (round)	175		240
MP 360 (KA)	 Multipurpose Lock 22mm (sqr.)	185		120
MP 370 (KA)	 Multipurpose Lock 32mm (sqr.)	195		120

Multipurpose Locks	Description	Finish Available		Std. Pkg.
		NI		
MP 460 (KA)	 Multipurpose Lock 22mm (sqr.)	245		120
MP 470	 Multipurpose Lock 32mm (sqr.)	255		120
MP 490	 (SMART SUPERIA) Multipurpose Lock (sqr.)	225		120
AL 408	 (SWITCH LOCK) Wardrobe Lock	380		60

Secura Lock	Description	Finish Available		Std. Pkg.
		SS		
SECURA	 Wardrobe Lock (with dimple key)	AL 400 (22)		20
		530		
		AL 400		20
		530		
		AL 401 (32)		
550				
SMART SECURA	 Smart Secura Wardrobe Lock	SM 400 (23)		20
		400		
		SM 401 (32)		20
		425		
SECURA	 Wardrobe Lock (with dimple key)	AL 402 (38)		20
		615		
SECURA	 Drawer Lock (with dimple key)	AL 410 (20)		60
		405		
		AL 411 (25)		60
		420		
		AL 412 (32)		60
		490		
SECURA	 Drawer Lock (with dimple key)	AL 210 (20)		60
		365		
		AL 211 (25)		60
		395		
		AL 212 (32)		60
		445		
SMART SECURA	 Smart Secura Wardrobe Lock	SM 210 SS/IV		20
		250 / 225		
		SM 211 SS/IV		20
		285 / 270		
		SM 212 SS/IV		20
		335 / 320		

Sliding Lock	Description	Finish Available		Std. Pkg.
		NS		
AL 500	 Sliding Door Wardrobe Lock	AL 500 (25)		20
		655		
AL 501	 Sliding Door Wardrobe Lock	AL 501 (32)		20
		700		

Push Lock	Description	Finish Available		Std. Pkg.
		SS		
MP 200SS 22mm	 Push Lock	MP 200 SS		20
		185		
MP 202SS 32mm	 Push Lock	MP 202 SS		20
		225		

Hextech Lock	Description	Finish Available		Std. Pkg.
		SS		
AL 450 SS	 Hextech Cupboard Lock	AL 450		20
		540		

Note: Key Alike sets are available in code MP360, MP370, MP460, AL400, AL401,AL410 AL 411, AL 450, SM 400 & SM 401, AL 500, AL 501.

GUIDELINES FOR ORDERING COMBO SET

HL Lock Set (e.g ZOVI)

Available as a set of 8" mortise Handles & mortise lock body (ML 170) & with or without cylinder.

For ordering HL concept with variable cylinder options, use below mentioned product code system

Handle Cylinder Option	Cylinder Sizes	
	60mm	70mm
Both Side Key	HL ZOV SS	HL ZOV 06 SS
Knob and Key	HL ZOV A SS	HL ZOV 07 SS
Coin and Knob	HL ZOV 02 SS	HL ZOV 08 SS
Mortise Latch	HL ZOV B SS	
Mortise Lever Lock (KY)	HL ZOV SS (KY)	
Without Cylinder	HL ZOV SS (W/O CL)	

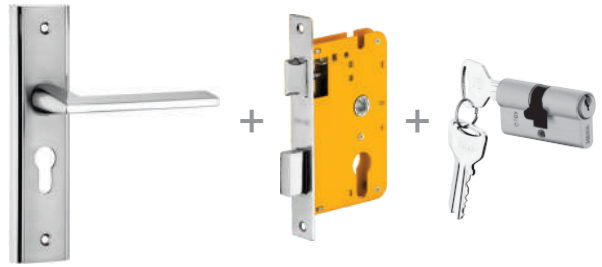

ML Lock Set (e.g Ceto)

Available as a set of 10" Mortise handles & mortise lock body (ML110) & with or without cylinder.

For ordering ML concept with variable cylinder options, use below mentioned product code system.

Handle Cylinder Option	Cylinder Sizes	
	60mm	70mm
Both Side Key	ML ZOV SS	ML ZOV 06 SS
Knob and Key	ML ZOV A SS	ML ZOV 07 SS
Coin and Knob	ML ZOV 02 SS	ML ZOV 08 SS
Without Cylinder	ML ZOV SS (W/O CL)	



ML OR Lock Set (e.g Ceto)



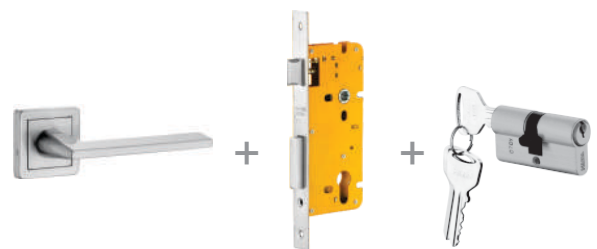

Available as a set of Rosette handles & mortise lock body (ML 110) & with or without cylinder.

For ordering ML OR concept with variable cylinder options, use below mentioned product code system.

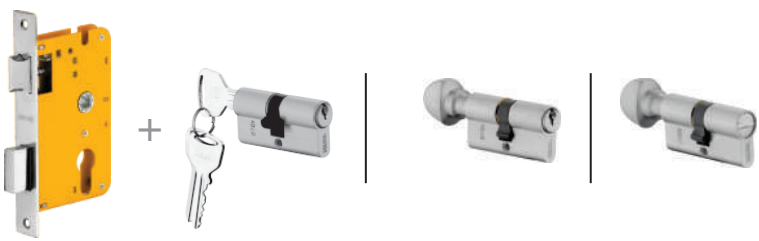

Handle Cylinder Option	Cylinder Sizes	
	60mm	70mm
Both Side Key	ML ZOV OR SS	ML ZOV OR 06 SS
Knob and Key	ML ZOV OR A SS	ML ZOV OR 07 SS
Coin and Knob	ML ZOV OR 02 SS	ML ZOV OR 08 SS
Mortise Latch	ML ZOV WR SS	
Without Cylinder	ML ZOV OR SS (W/O CL)	

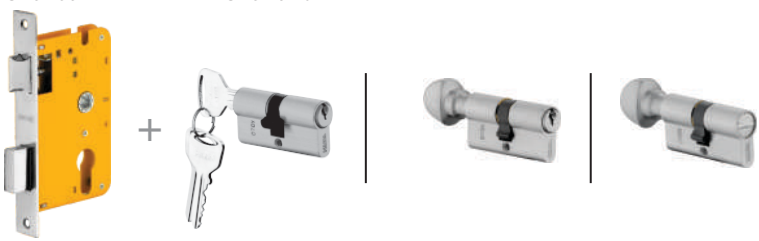

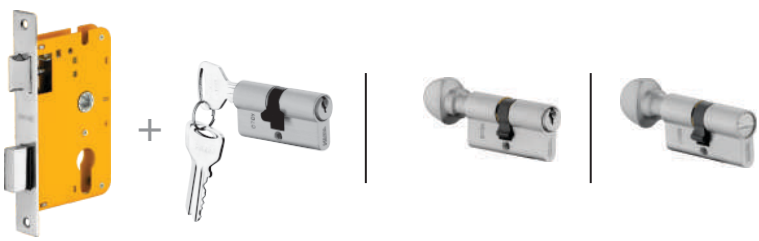
Lock Sets | HL Series (8" On Plate) Combo Set

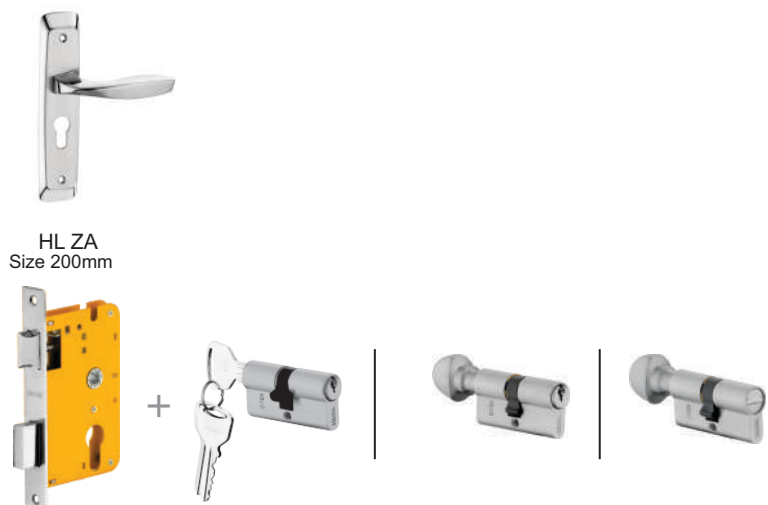
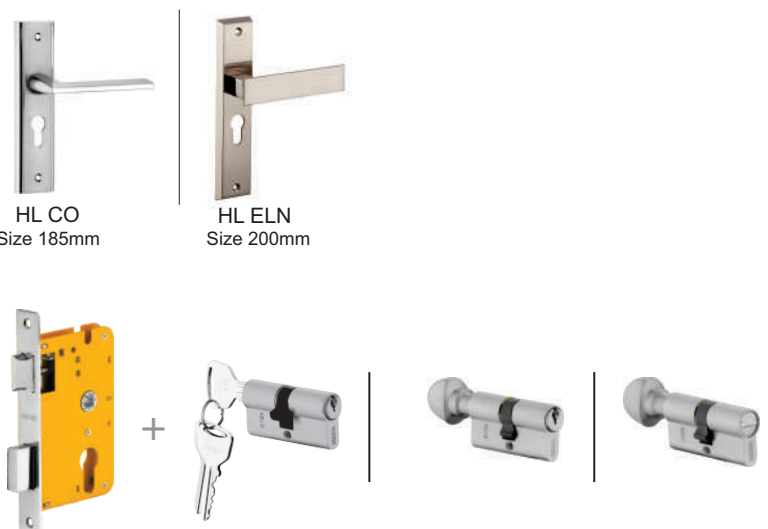
	Description	Finish Available		Std. Pkg.
		SS/SC/PT	WD	
<p>Zovi Kaira Odiun</p>  <p>HL ZOV HL KAI HL ODI (WD SC PT) NEW</p> 	With Both Side Key Cylinder (60mm)	2485	2545	4
	With Knob and Key Cylinder (60mm)	2545	2595	4
	With Coin and Knob Cylinder (60mm)	2485	2545	4
	With Both Side Key Cylinder (70mm)	2545	2595	4
	With Knob and Key Cylinder (70mm)	2595	2650	4
	With Coin and Knob Cylinder (70mm)	2545	2595	4
	With Mortise Lever Lock (KY)	1985	2045	4
<p>Hale Dash</p>  <p>HL HALE Size 190mm HL DAS Size 204.3mm</p> 	With Both Side Key Cylinder (60mm)	3035		4
	With Knob and Key Cylinder (60mm)	3090		4
	With Coin and Knob Cylinder (60mm)	3035		4
	With Both Side Key Cylinder (70mm)	3090		4
	With Knob and Key Cylinder (70mm)	3145		4
	With Coin and Knob Cylinder (70mm)	3090		4
	With Mortise Lever Lock (KY)	2215		4
<p>Deolo</p>  <p>HL DEO Size 200mm</p> 	With Both Side Key Cylinder (60mm)	3330		4
	With Knob and Key Cylinder (60mm)	3380		4
	With Coin and Knob Cylinder (60mm)	3330		4
	With Both Side Key Cylinder (70mm)	3390		4
	With Knob and Key Cylinder (70mm)	3450		4
	With Coin and Knob Cylinder (70mm)	3390		4
	With Mortise Lever Lock (KY)	2260		4

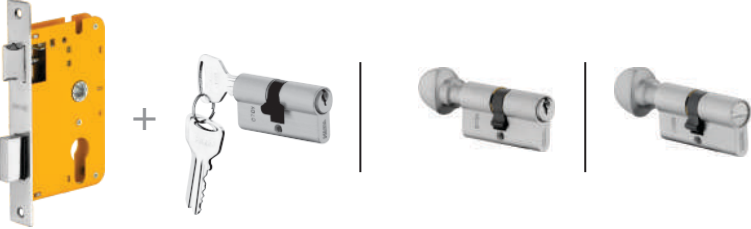
Lock Sets HL Series (8" On Plate) Combo Set		Description	Finish Available	Std. Pkg.
			SS/SC/PT	
<p>Zara</p>  <p>HL ZA Size 200mm</p>	With Both Side Key Cylinder (60mm)	3450	4	
	With Knob and Key Cylinder (60mm)	3505	4	
	With Coin and Knob Cylinder (60mm)	3450	4	
	With Both Side Key Cylinder (70mm)	3515	4	
	With Knob and Key Cylinder (70mm)	3575	4	
	With Coin and Knob Cylinder (70mm)	3515	4	
	With Mortise Lever Lock (KY)	2290	4	
<p>Ceto Elina</p>  <p>HL CO Size 185mm</p> <p>HL ELN Size 200mm</p>	With Both Side Key Cylinder (60mm)	3605	4	
	With Knob and Key Cylinder (60mm)	3665	4	
	With Coin and Knob Cylinder (60mm)	3605	4	
	With Both Side Key Cylinder (70mm)	3665	4	
	With Knob and Key Cylinder (70mm)	3720	4	
	With Coin and Knob Cylinder (70mm)	3665	4	
	With Mortise Lever Lock (KY)	2430	4	

Lock Sets HL Series (8" On Plate) Combo Set		Description	Finish Available		Std. Pkg.
			SS/SC/PT		
<p>Dave Onix</p>  <p>HL DAV Size 190mm</p> <p>HL ON Size 185mm</p> 	With Both Side Key Cylinder (60mm)	3765		4	
	With Knob and Key Cylinder (60mm)	3820		4	
	With Coin and Knob Cylinder (60mm)	3765		4	
	With Both Side Key Cylinder (70mm)	3820		4	
	With Knob and Key Cylinder (70mm)	3880		4	
	With Coin and Knob Cylinder (70mm)	3820		4	
	With Mortise Lever Lock (KY)	2695		4	
	<p>Stella Cosmo Noha</p>  <p>HL ST Size 204mm</p> <p>HL CS Size 204mm</p> <p>HL NO Size 204mm</p> 	With Both Side Key Cylinder (60mm)	3820		4
With Knob and Key Cylinder (60mm)		3880		4	
With Coin and Knob Cylinder (60mm)		3820		4	
With Both Side Key Cylinder (70mm)		3890		4	
With Knob and Key Cylinder (70mm)		3945		4	
With Coin and Knob Cylinder (70mm)		3890		4	
With Mortise Lever Lock (KY)		2665		4	

Latch Sets HL Series (8" On Plate) Combo Set		Description	Finish Available		Std. Pkg.
			SS/SC/PT	SSWD	
Zovi Kaira Odiun		With Mortise Latch	1960	2020	4
Hale Dash		With Mortise Latch	2165		4
Deolo		With Mortise Latch	2340		4
Zara		With Mortise Latch	2430		4
Ceto Elina		With Mortise Latch	2430		4
Dave Onix		With Mortise Latch	2695		4
Stella Cosmo Noha		With Mortise Latch	2665		4

Lock Sets K Series	K series	Description	Finish Available- SC/PT			Std. Pkg.
			CHORD	OBLO	BRITO	
Chord Oblo Brito  HL CHO SC Size 178mm HL OBL SC Size 175mm HL BRT SC Size 178mm K PLUS	With Both Side Key Cylinder (60mm)	2380	2035	2350	4	
	With Key & Knob Cylinder (60mm)	2440	2090	2400	4	
	With Both Side Key Cylinder (70mm)	2440	2090	2400	4	
	With Key & Knob Cylinder (70mm)	2490	2140	2460	4	



Lock Sets K Series	K series	Description	Finish Available- SC/PT		Std. Pkg.
			SKEW	BOW	
Skew Bow  HL SKE SC Size 175mm HL BOW SC Size 176mm K PLUS	With Both Side Key Cylinder (60mm)	2350	2380	4	
	With Key & Knob Cylinder (60mm)	2400	2440	4	
	With Both Side Key Cylinder (70mm)	2400	2440	4	
	With Key & Knob Cylinder (70mm)	2460	2490	4	

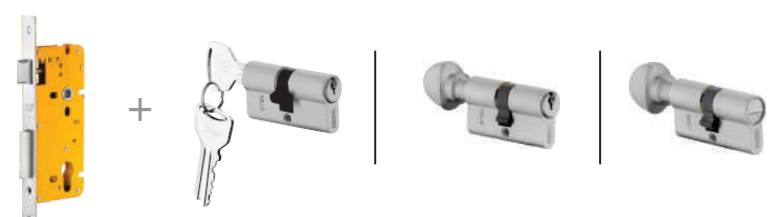

Lock Sets K Series	Description	Finish Available- SC/PT			Std.
		CHORD	OBLO	BRITO	
Chord Oblo Brito  HL CHO SC Size 178mm HL OBL SC Size 175mm HL BRT SC Size 178mm KY	With Mortise Lever Lock (KY)	1830	1385	1385	6

Lock Sets K Series	Description	Finish Available- SC/PT		Std. Pkg.
		SKEW	BOW	
Skew Bow  HL SKE SC Size 175mm HL BOW SC Size 176mm KY	With Mortise Lever Lock (KY)	1525	1565	6

Latch Sets K Series	Description	Finish Available	Std. Pkg.
		SC/PT	
Skew Bow Chord	With Mortise Latch	1395	4
Oblo Brito	With Mortise Latch	1260	4

















Lock Sets ML Series (10" On Plate) Combo Set	Description	Finish Available		Std. Pkg.
		SS/SC/PT	WD	
<p>Zovi Kaira Odiun</p>  <p>ML ZOV ML KAI ML ODI (WD SC PT) NEW</p> 	With Both Side Key Cylinder (60mm)	2870	2930	4
	With Knob and Key Cylinder (60mm)	2930	2980	4
	With Coin and Knob Cylinder (60mm)	2870	2930	4
	With Both Side Key Cylinder (70mm)	2930	2980	4
	With Knob and Key Cylinder (70mm)	2980	3035	4
	With Coin and Knob Cylinder (70mm)	2930	2980	4



<p>Hale Dash</p>  <p>ML HALE Size 240mm ML DAS Size 253.8mm</p> 	With Both Side Key Cylinder (60mm)	3405		4
	With Knob and Key Cylinder (60mm)	3460		4
	With Coin and Knob Cylinder (60mm)	3405		4
	With Both Side Key Cylinder (70mm)	3460		4
	With Knob and Key Cylinder (70mm)	3515		4
	With Coin and Knob Cylinder (70mm)	3460		4

<p>Deolo</p>  <p>ML DEO Size 250mm</p> 	With Both Side Key Cylinder (60mm)	3765		4
	With Knob and Key Cylinder (60mm)	3820		4
	With Coin and Knob Cylinder (60mm)	3765		4
	With Both Side Key Cylinder (70mm)	3820		4
	With Knob and Key Cylinder (70mm)	3880		4
	With Coin and Knob Cylinder (70mm)	3820		4

Lock Sets ML Series (10" On Plate) Combo Set		Description	Finish Available	Std. Pkg.
			SS/SC/PT	
<p>Zara</p>  <p>ML ZA Size 250mm</p> 	With Both Side Key Cylinder (60mm)	3820	4	
	With Knob and Key Cylinder (60mm)	3880	4	
	With Coin and Knob Cylinder (60mm)	3820	4	
	With Both Side Key Cylinder (70mm)	3890	4	
	With Knob and Key Cylinder (70mm)	3945	4	
	With Coin and Knob Cylinder (70mm)	3890	4	
<p>Ceto Elina</p>  <p>ML CO Size 250mm</p> <p>ML ELN Size 250mm</p> 	With Both Side Key Cylinder (60mm)	4105	4	
	With Knob and Key Cylinder (60mm)	4155	4	
	With Coin and Knob Cylinder (60mm)	4105	4	
	With Both Side Key Cylinder (70mm)	4155	4	
	With Knob and Key Cylinder (70mm)	4215	4	
	With Coin and Knob Cylinder (70mm)	4155	4	



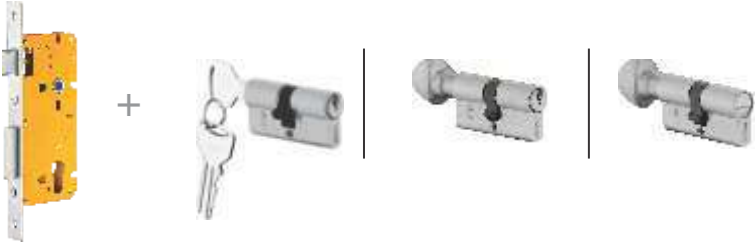

















Lock Sets ML Series (10" On Plate) Combo Set		Description	Finish Available	Std. Pkg.
			SS/SC/PT	
Dave Onix  ML DAV Size 240mm ML ON Size 250mm 		With Both Side Key Cylinder (60mm)	4155	4
		With Knob and Key Cylinder (60mm)	4215	4
		With Coin and Knob Cylinder (60mm)	4155	4
		With Both Side Key Cylinder (70mm)	4225	4
		With Knob and Key Cylinder (70mm)	4280	4
		With Coin and Knob Cylinder (70mm)	4225	4
		Stella Cosmo Noha  ML ST Size 223mm ML CS Size 245mm ML NO Size 245mm 		With Both Side Key Cylinder (60mm)
With Knob and Key Cylinder (60mm)	4310			4
With Coin and Knob Cylinder (60mm)	4260			4
With Both Side Key Cylinder (70mm)	4310			4
With Knob and Key Cylinder (70mm)	4370			4
With Coin and Knob Cylinder (70mm)	4310			4





















Lock Sets ML Series (On Rose) Combo Set		Description	Finish Available		Std. Pkg.
			SS/SC/PT	WD	
Zovi Kaira Odiun  ML ZOV OR  ML KAI OR  ML ODI OR (WD SC PT)  +   		With Both Side Key Cylinder (60mm)	2980	3035	4
		With Knob and Key Cylinder (60mm)	3035	3095	4
		With Coin and Knob Cylinder (60mm)	2980	3035	4
		With Both Side Key Cylinder (70mm)	3035	3095	4
		With Knob and Key Cylinder (70mm)	3095	3145	4
		With Coin and Knob Cylinder (70mm)	3035	3095	4
Hale Dash  ML HALE OR Size 52.5mm  ML DAS OR Size 52.5mm  +   		With Both Side Key Cylinder (60mm)	3525		4
		With Knob and Key Cylinder (60mm)	3585		4
		With Coin and Knob Cylinder (60mm)	3525		4
		With Both Side Key Cylinder (70mm)	3585		4
		With Knob and Key Cylinder (70mm)	3640		4
		With Coin and Knob Cylinder (70mm)	3585		4
Deolo  ML DEO OR Size 50.4mm  +   		With Both Side Key Cylinder (60mm)	3890		4
		With Knob and Key Cylinder (60mm)	3945		4
		With Coin and Knob Cylinder (60mm)	3890		4
		With Both Side Key Cylinder (70mm)	3945		4
		With Knob and Key Cylinder (70mm)	4000		4
		With Coin and Knob Cylinder (70mm)	3945		4



















Lock Sets ML Series (On Rose) Combo Set		Description	Finish Available	Std. Pkg.
			SS/SC/PT	
<p>Zara</p>  <p>ML ZA OR Size 50.4mm</p> 	With Both Side Key Cylinder (60mm)	4260	4	
	With Knob and Key Cylinder (60mm)	4310	4	
	With Coin and Knob Cylinder (60mm)	4260	4	
	With Both Side Key Cylinder (70mm)	4310	4	
	With Knob and Key Cylinder (70mm)	4370	4	
	With Coin and Knob Cylinder (70mm)	4310	4	
	<p>Ceto Elina</p>  <p>ML CO OR Size 54mm</p>  <p>ML ELN OR Size 52.5mm</p> 		With Both Side Key Cylinder (60mm)	4260
With Knob and Key Cylinder (60mm)	4310	4		
With Coin and Knob Cylinder (60mm)	4260	4		
With Both Side Key Cylinder (70mm)	4310	4		
With Knob and Key Cylinder (70mm)	4370	4		
With Coin and Knob Cylinder (70mm)	4310	4		



Lock Sets ML Series (On Rose) Combo Set		Description	Finish Available		Std. Pkg.
			SS/SC/PT	WD	
Dave Onix  ML DAV OR Size 54mm ML ON OR Size 52mm 		With Both Side Key Cylinder (60mm)	4310		4
		With Knob and Key Cylinder (60mm)	4370		4
		With Coin and Knob Cylinder (60mm)	4310		4
		With Both Side Key Cylinder (70mm)	4380		4
		With Knob and Key Cylinder (70mm)	4440		4
		With Coin and Knob Cylinder (70mm)	4380		4
Stella Cosmo Noha  ML ST OR Size 55mm ML CS OR Size 55mm ML NO OR Size 54mm 		With Both Side Key Cylinder (60mm)	4380		4
		With Knob and Key Cylinder (60mm)	4440		4
		With Coin and Knob Cylinder (60mm)	4380		4
		With Both Side Key Cylinder (70mm)	4440		4
		With Knob and Key Cylinder (70mm)	4495		4
		With Coin and Knob Cylinder (70mm)	4440		4

Latch Sets ML Series (On Rose) Combo Set		Description	Finish Available		Std. Pkg.
			SS/SC/PT	WD	
Zovi Kaira Odiun		With Mortise Latch	1660	1710	4
Hale Dash		With Mortise Latch	1855		4
Deolo		With Mortise Latch	1970		4
Zara		With Mortise Latch	2125		4
Ceto Elina		With Mortise Latch	2125		4
Dave Onix		With Mortise Latch	2195		4
Stella Cosmo Noha		With Mortise Latch	2380		4

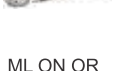
Lock Sets With Lock Body & Without Cylinder HL Combo Set		Finish Available		Std. Pkg.		
		SS/ SC/ PT	WD			
HL Series (8" on Plate)	Zovi Kaira Odiun  +    HL ZOV W/O CL HL KAI W/O CL HL ODI W/O CL			2065	2120	4
	HL Series (8" on Plate)	Hale Dash  +   HL HALE W/O CL HL DAS W/O CL			2575	
HL Series (8" on Plate)		Deolo  +  HL DEO W/O CL			2900	
	HL Series (8" on Plate)	Zara  +  HL ZA W/O CL			3025	
HL Series (8" on Plate)		Ceto Elina  +   HL CO W/O CL HL ELN W/O CL			3180	
	HL Series (8" on Plate)	Dave Onix  +   HL DAV W/O CL HL ON W/O CL			3360	
HL Series (8" on Plate)		Stella Cosmo Noha  +    HL ST W/O CL HL CS W/O CL HL NO W/O CL			3415	

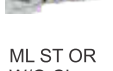
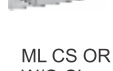
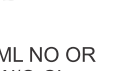
Lock Sets With Lock Body & Without Cylinder ML Combo Set		Finish Available		Std. Pkg.		
		SS/ SC/ PT	WD			
ML Series (10" on Plate)	Zovi Kaira Odiun  +   			2440	2495	4
	ML ZOV W/O CL ML KAI W/O CL ML ODI W/O CL					
ML Series (10" on Plate)	Hale Dash  +  			2965		4
	ML HALE W/O CL ML DAS W/O CL					
ML Series (10" on Plate)	Deolo  + 			3360		4
	ML DEO W/O CL					
ML Series (10" on Plate)	Zara  + 			3495		4
	ML ZA W/O CL					
ML Series (10" on Plate)	Ceto Elina  +  			3695		4
	ML CO W/O CL ML ELN W/O CL					
ML Series (10" on Plate)	Dave Onix  +  			3775		4
	ML DAV W/O CL ML ON W/O CL					
ML Series (10" on Plate)	Stella Cosmo Noha  +   			3880		4
	ML ST W/O CL ML CS W/O CL ML NO W/O CL					

Lock Sets With Lock Body & Without Cylinder ML Combo Set (on Rose)		Finish Available		Std. Pkg.
		SS/SC/PT	WD	
ML Series (On Rose)	<p>Zovi Kaira Odiun</p>  +  ML ZOV OR W/O CL  ML KAI OR W/O CL  ML ODI OR W/O CL NEW	2575	2630	4
ML Series (On Rose)	<p>Hale Dash</p>  +  ML HALE OR W/O CL  ML DAS OR W/O CL	3115		4
ML Series (On Rose)	<p>Deolo</p>  +  ML DEO OR W/O CL	3485		4
ML Series (On Rose)	<p>Zara</p>  +  ML ZA OR W/O CL	3880		4
ML Series (On Rose)	<p>Ceto Elina</p>  +  ML CO OR W/O CL  ML ELN OR W/O CL	3880		4
ML Series (On Rose)	<p>Dave Onix</p>  +  ML DAVOR OR W/O CL  ML ON OR W/O CL	3930		4
ML Series (On Rose)	<p>Stella Cosmo Noha</p>  +  ML ST OR W/O CL  ML CS OR W/O CL  ML NO OR W/O CL	4015		4

Lock Sets Brass HL 8" Combo Set		Description	Finish Available			Std. Pkg.
			Brass	SS	PT	
HL Series (8" on Plate)	Diva  HL 170	With Both Side Key Cylinder (60mm)	4135	4135	4135	4
		With Knob and Key Cylinder (60mm)	4190	4190	4190	4
		With Bathroom Lock System	3730	3730	3730	4
HL Series (8" on Plate)	Biva  HL 160	With Mortise Lock	3010	3010	3010	4

Latch Sets Brass HL 8" Combo Set		Description	Finish Available			Std. Pkg.
			Brass	SS	PT	
Diva		With Mortise Latch	3415	3415	3415	4
Biva		With Mortise Latch	2910	2910	2910	4

Lock Sets With Lock Body & Without Cylinder Brass		Finish Available			Std. Pkg.	
		Brass	SS	PT		
HL Series (8" on Plate)	Diva  HL 170 W/O CL		3710	3710	3710	4

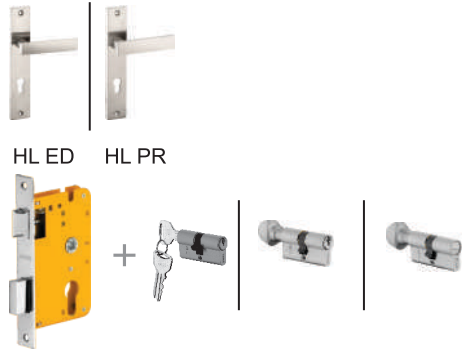
Lock Sets SS HL 8" Combo Set		Description	Finish Available	Std. Pkg.
			SS	
HL Series (8" on Plate)	Eden Primo  HL ED HL PR	With Both Side Key Cylinder (60mm)	3540	4
		With Knob and Key Cylinder (60mm)	3595	4
		With Coin and Knob Cylinder (60mm)	3540	4
		With Both Side Key Cylinder (70mm)	3820	4
		With Knob and Key Cylinder (70mm)	3880	4
		With Coin & Knob Cylinder (70mm)	3820	4



Latch Sets SS HL 8" Combo Set	Description	Finish Available		Std. Pkg.
		SS		
Eden I Primo	With Mortise Latch	2820		4

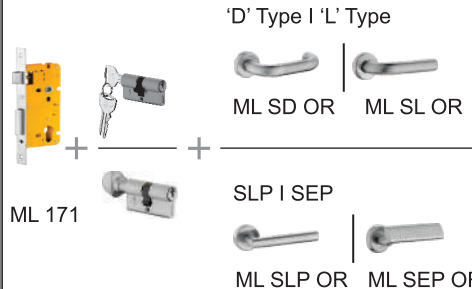

Lock Sets SS ML 10" Combo Set	Description	Finish Available		Std. Pkg.
		SS		
ML Series (10" on Plate) 	Eden I Primo With Both Side Key Cylinder (60mm)	3880		4
	With Knob and Key Cylinder (60mm)	3930		4
	With Coin and Knob Cylinder (60mm)	3880		4
	With Both Side Key Cylinder (70mm)	4155		4
	With Knob and Key Cylinder (70mm)	4215		4
	With Coin and Knob Cylinder (70mm)	4155		4

Lock Sets SS ML On Rose Combo Set	Description	Finish Available		Std. Pkg.
		SS		
ML Series (On Rose) 	Eden I Primo With Both Side Key Cylinder (60mm)	3880		4
	With Knob and Key Cylinder (60mm)	3930		4
	With Coin and Knob Cylinder (60mm)	3880		4
	With Mortise Latch	3890		4
	With Both Side Key Cylinder (70mm)	4155		4
	With Knob and Key Cylinder (70mm)	4215		4
	With Coin and Knob Cylinder (70mm)	4155		4



Latch Sets SS ML On Rose Combo Set	Description	Finish Available		Std. Pkg.
		SS		
Eden I Primo	With Mortise Latch	2820		4



Lock Sets SS ML On Rose Combo Set	Description	SS		Std. Pkg.	
		19mm dia	22mm dia		
ML Series (On Rose) 	With Both Side Key Cylinder (60mm)	2880	2920	4	
	With Knob and Key Cylinder (60mm)	2930	2980	4	
	SS				Std. Pkg.
	With Both Side Key Cylinder (60mm)	3390		4	
	With Knob and Key Cylinder (60mm)	3450		4	













Lock Sets With Lock Body & Without Cylinder SS			Finish Available		Std. Pkg.
			SS		
HL Series (8" on Plate)	Eden I Primo		3145		4
	 ML 170	 +  HL ED W/O CL HL PR W/O CL			

Lock Sets With Lock Body & Without Cylinder SS			Finish Available		Std. Pkg.
			SS		
ML Series (10" on Plate)	Eden I Primo		3485		4
	 ML 110 SS	 +  ML ED W/O CL ML PR W/O CL			







Lock Sets With Lock Body & Without Cylinder SS			Finish Available		Std. Pkg.
			SS		
ML Series (On Rose)	Eden I Primo		3485		4
	 ML 171	 +  ML ED OR W/O CL ML PR OR W/O CL			

Lock Sets SS ML On Rose Combo Set (without cylinder)			SS		Std. Pkg.
			19mm dia	22mm dia	
ML Series (On Rose)	'D' Type 'L' Type		2495	2540	4
	 ML 171	 +  ML SD OR W/O CL ML SL OR W/O CL			

Lock Sets SS ML On Rose Combo Set (without cylinder)			SS		Std. Pkg.
ML Series (On Rose)	SLP SEP		3010		4
	 ML 171	 +  ML SLP OR W/O CL ML SEP OR W/O CL			

Door Closers		Description	Weight	MRP	Std. Pkg.
FR 80		Door Closer	80 Kg	2810	10
DC 80 Ext. (WP) GM		Door Closer	80 Kg	4330	6
DC 80 Ext. (WP) ANTIQUE		Door Closer Ext Antique	80 Kg	4330	6
DC 80 Ext. (WP) SS		Door Closer Ext With Palmet Arm in SS finish	80 Kg	4330	6
DC 80 Ext. (WP) PAINT		Door Closer Ext With Palmet Arm	80 Kg	3310	6
DC 80 Ext		Door Closer Ext	80 Kg	3060	8
DC 80 PDC		Door Closer PDC	80 Kg	2555	8
DC 80 PDC (WP)		Door Closer PDC With Palmet Arm	80 Kg	2780	8
DC 85 CO		Concealed Door Closer	60 to 85 Kg	5615	4
DC 65 CO		Concealed Door Closer	40 to 65 Kg	5310	4
DC 40 SM		Door Closer	40 Kg	1345	6
DC 60 SM		Door Closer	60 Kg	1570	6

Floor Spring		Description	Weight	MRP	Std. Pkg.
FS 7070		Floor Spring (without BP/TP)	Upto 70 Kg	3595	4
FS 100		Floor Spring (without BP/TP)	65-100 Kg	5965	2
FS 120		Floor Spring (without BP/TP)	100-120 Kg	6195	2
FS 150		Floor Spring (without BP/TP)	120-150 Kg	6670	2
FS 6080		Floor Spring (without BP/TP)	Upto 90 Kg	4465	2
FS 6120		Floor Spring (without BP/TP)	Upto 120 Kg	4915	2
FS TP/BP		Top - Bottom Pivot Suitable for Wooden Door/ Aluminum Door		740	2

Glass Combo Set		Description	Weight	MRP
CS 70 WL		Glass Combo Set With Lock Patch, Top & Bottom Patch Fittings	Upto 70 Kg	7210
CS 70		Glass Combo Set With Top & Bottom Patch Fittings (Without Lock Patch)	Upto 70 Kg	5180
CS 80 WL		Glass Combo Set With Lock Patch, Top & Bottom Patch Fittings	Upto 80 Kg	7980
CS 80		Glass Combo Set With Top & Bottom Patch Fittings (Without Lock Patch)	Upto 80 Kg	5950
CS 100 WL		Glass Combo Set With Lock Patch, Top & Bottom Patch Fittings	Upto 100 Kg	10850
CS 100		Glass Combo Set With Top & Bottom Patch Fittings (Without Lock Patch)	Upto 100 Kg	8800

Door Weight Calculation Chart for Door Closer & Floor Spring

Glass Door Weight			
Size			Weight (Kg)
Width (ft)	Height (ft)	Thickness (mm)	
2.5	7	6	24.3
2.5	8	6	27.8
3	7	6	29.1
3	8	6	33.3
3.5	7	6	34.0
4	8	6	44.4
4.5	7	6	43.7
4.5	8	6	50.0
5	7	6	48.6
5	8	6	55.5

2.5	7	8	32.4
2.5	8	8	37.0
3	7	8	38.9
3	8	8	44.4
3.5	7	8	45.3
4	8	8	59.2
4.5	7	8	58.3
4.5	8	8	66.6
5	7	8	64.8
5	8	8	74.0

2.5	7	12	48.6
2.5	8	12	55.5
3	7	12	58.3
3	8	12	66.6
3.5	7	12	68.0
4	8	12	88.8
4.5	7	12	87.4
4.5	8	12	99.9
5	7	12	97.2
5	8	12	111.0

Indian Teak Door Weight				
Size			Material Density (FOS)	Weight (Kg)
Width (ft)	Height (ft)	Thickness (mm)		
2.5	7	36.1	1.25	27.1
2.5	8	41.3	1.25	31.0
3	7	43.4	1.25	32.5
3	8	49.6	1.25	37.2
3.5	7	50.6	1.25	37.9
4	8	66.1	1.25	49.6
4.5	7	65.0	1.25	48.8
4.5	8	74.3	1.25	55.7
5	7	72.3	1.25	54.2
5	8	82.6	1.25	61.9

Indian Teak Door Weight				
Size			Material Density (FOS)	Weight (Kg)
Width (ft)	Height (ft)	Thickness (mm)		
2.5	7	43.4	1.5	32.5
2.5	8	49.6	1.5	37.2
3	7	52.0	1.5	39.0
3	8	59.5	1.5	44.6
3.5	7	60.7	1.5	45.5
4	8	79.3	1.5	59.5
4.5	7	78.0	1.5	58.5
4.5	8	89.2	1.5	66.9
5	7	86.7	1.5	65.0
5	8	99.1	1.5	74.3

2.5	7	50.6	1.75	37.9
2.5	8	57.8	1.75	43.4
3	7	60.7	1.75	45.5
3	8	69.4	1.75	52.0
3.5	7	70.8	1.75	53.1
4	8	92.5	1.75	69.4
4.5	7	91.1	1.75	68.3
4.5	8	104.1	1.75	78.0
5	7	101.2	1.75	75.9
5	8	115.6	1.75	86.7

2.5	7	57.8	2	43.4
2.5	8	66.1	2	49.6
3	7	69.4	2	52.0
3	8	79.3	2	59.5
3.5	7	80.9	2	60.7
4	8	105.7	2	79.3
4.5	7	104.1	2	78.0
4.5	8	118.9	2	89.2
5	7	115.6	2	86.7
5	8	132.1	2	99.1

Note:

1. For Selection of Floor Spring for glass door factor of safety should be taken as 1.
2. For Selection of Door closers for wooden door factor of safety should be taken as 1.

SS 2 Ball Bearing Hinges (with screw)	Size	Code	Finish	Std. Pkg.
			SS	
	76 X 64 X 2MM	HG 1150	220	40
	102 X 76 X 2.5MM	HG 1151	360	40
	127 X 76 X 2.5MM	HG 1152	420	40
	102 X 76 X 3MM	HG 1153	390	40
	127 X 76 X 3MM	HG 1154	465	40

SS Flush Hinge (With Screw)	Size	Code	Finish
			SS
	100x37x2.5 MM (SS 304)	BHG6150A SS	310
	100x37x2.5 MM	BHG6150SS SM	245

SS 2 Ball Bearing Hinges (with screw)	Size	Code	Finish	Std. Pkg.
			SS	
 SS Grade 304 Upto 2 Hour Fire Rated	102 X 76 X 2.5MM	HG 1151 A	430	40
	127 X 76 X 2.5MM	HG 1152 A	510	40
	102 X 76 X 3MM	HG 1153 A	480	40
	127 X 76 X 3MM	HG 1154 A	575	40

Brass Tower Bolt (with screw)	Description	Finish	
		EP	SS/PT
	TR 310 - 03"	300	355
	TR 410 - 04"	480	530
	TR 610 - 06"	620	655
	TR 810 - 08"	750	785
	TR 1010 - 10"	910	945
	TR 1210 - 12"	1075	1125

SS Pin Type Hinge (without screw)	Size	Code	Finish	Std. Pkg.
			SS	
	75X48X1.7MM	HG 2150	70	60
	75X48X2.5MM	HG 2150 H	100	60
	100X58X1.9MM	HG 2151	110	60
	100X61X2.5MM	HG 2151 H	145	60
	125X61X1.9MM	HG 2152	145	60
	125X65X2.5MM	HG 2152 H	185	60

SS Tower Bolt (with screw)	Description	Finish	Std. Pkg.
		SS	
	TS-410 - 04"	135	60
	TS-610 - 06"	200	60
	TS-810 - 08"	245	60
	TS-1010 - 10"	310	60
	TS-1210 - 12"	370	60
	TS-1810 - 18"	585	60

SS 2 Ball Bearing Hinges (with screw)	Size	Code	Finish	Std. Pkg.
			SS	
 SS Grade 304	127 X 76 X 2.5MM	HGRC 1152 A	525	40
	102 X 76 X 3MM	HGRC 1153 A	490	40

Kadi Tala	Size	Code	Finish	Std. Pkg.
			NI	
	200 MM	KDT 200 NI	945	10
	275 MM	KDT 275 NI	1050	10

SS 2 Ball Bearing Hinges (with screw)	Size	Code	Finish	Std. Pkg.
			SS	
 For Steel Door Fire Rated Upto 2 Hours	102x76x3mm	HG 1253	460	40

Door Accessories		Description	MRP
ME (B)		Magic Eye Big (Brass)	410
MEF (S)		Magic Eye Small with Flap (Brass)	340
DGBT		Door Guard Buckel Type (Brass)	780
DS HR (SS)		Door Stopper Floor Mounted Half Round (SS 304)	325
DS HR (Z)		Door Stopper Floor Mounted Half Round (Zamak)	185
DB WC (Z)		Door Buffer- Wall Mounted Dia 22mm Ht. 75mm with Cover (Stainless Steel)	255
DB (Z)		Door Buffer- Wall Mounted Dia 22mm Ht. 75mm without Cover (Stainless Steel)	220
DS HT		Door Stopper- Door Mounted Hanging Type (Brass)	355
DS HT (Z)		Door Stopper- Door Mounted Hanging Type (Zamak)	305
MDS-CL MDS-GM	NEW	Concealed Door Stopper (MAGNETO)	735

Door Accessories		Description	MRP
DSC (M)		Door Safety Chain- Manually (Brass & Stainless Steel)	460
BL (S)		Sliding Bolt (Baby Latch) with Stainless Steel Lock Strip 03" (Body in Zinc)	200
BL (B)		Sliding Bolt (Baby Latch) with SS Lock Strip 05"	325
IB 390		Indicator Bolt	600
DDDL		Double Door Attachment- For Dead Lock (Brass) - SS Finish	580
DDML		Double Door Attachment- For Mortise Lock (Brass) - SS Finish	850
DDML (ML170)		Double Door Attachment - For ML170 (Brass) - SS Finish	850
DBPVC-W		Door Buffer 03" PVC White	40
DBRB-B		Door Buffer 03" Rubber Black	40
MDC SS304	NEW	Magnetic Door Catcher	445

MAGNETO





MAGNETIC



**A SAFE WAY TO
KEEP DOORS OPEN**

AVOID TRIPS AND DAMAGED WALLS



Code	Straight Patch Fittings	Description	MRP
DPF-320		Top Pivot	280
DPF-321		Top Patch	1630
DPF-322		Bottom Patch	1630
DPF-325		Center Patch Lock with Cylinder	2935

All Available in-PSS: Polished

TERMS & CONDITIONS

Product prices are subject to change without prior notice.

● **Ordering Procedure**

- * Order booking should be in multiples of standard packing wherever it is applicable.
- * Orders to be placed as per the guidelines of the company.
- * Orders should be placed in writing only
- * Discount may vary from product to product. Refer the price list.

● **Title and Risk for Goods**

- * Risk and Title in the Goods shall pass to the Purchaser upon the sooner of happening of the delivery to the delivery destination or upon the loading of the Goods on a third party vehicle or the Purchaser's vehicle for delivery to the delivery destination.
- * Notwithstanding the above, the Company possess the lien on the Goods sold to the Purchaser until the Company receives payment in full for all Goods and for all money owing by the Purchaser to the company on any account whatsoever. The Company will have the right to recover the money due by selling the said goods to the third party or by taking back the goods to the Company premises as the circumstances prevail.

● **Return guidelines for the damaged / short supplied goods.**

- * Any damaged or short material received must be immediately notified and any discrepancy must be clearly mentioned on pod/delivery receipt.
- * No claim will be entertained in case discrepancy is not notified in writing immediately.
- * No material for return shall be accepted by the company, in case valid claim is not filed in writing within 1 months of the date of invoice.
- * All original packing material to be returned.
- * All manuals and warranty registration cards must be unmarked. Upon receipt of return in accordance with the above terms, we shall issue a credit note.

All disputes are subject to Delhi Court.

Price list version - 2020/21

OUR PRODUCT CODING SYSTEM

coding | LEVER HANDLES

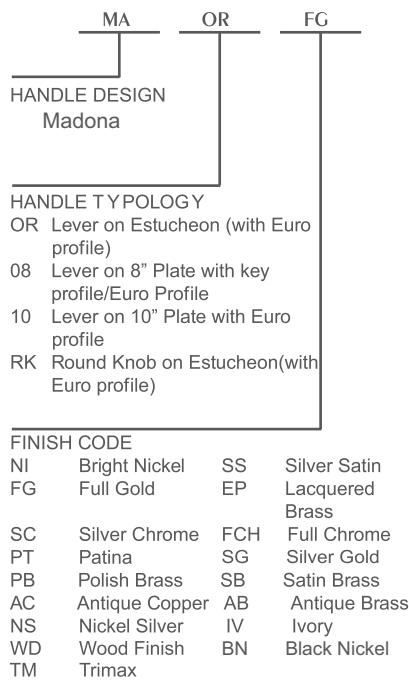

coding | PULL HANDLES

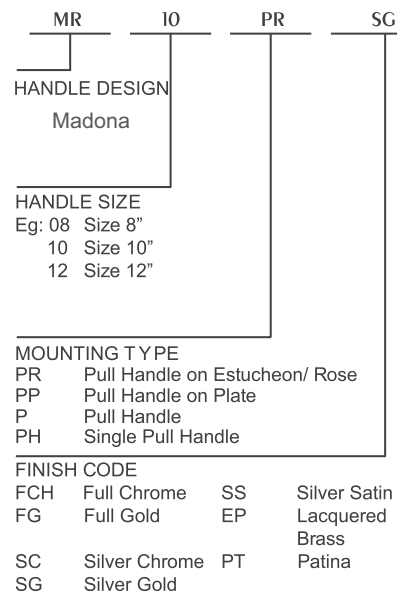

coding | EURO PROFILE CYLINDERS

	60mm	70mm	80mm	90mm	100mm
Euro Profile Brass Cylinder (both side key)	CL 200	CL 206	CL 203	CL 214	CL 211
Euro Profile Brass Cylinder (one side knob & one side key)	CL 201	CL 207	CL 204	CL 215	CL 212
Euro Profile Brass Cylinder (one side knob & one side emergency opening)	CL 202	CL 208	CL 205	CL 216	CL 213

Master key & Grand Master key available on request.
 Finishes - Bright Nickel (NI), Silver Satin (SS), Patina (PT), Full Gold (FG), Lacquered Brass (EP).

M.R.P. w.e.f. 20.05.2020



HINGE SYSTEM



IMPRO Adjustable Soft-Close Hinge introduces a totally new standard to the world of furniture accessories with the adjustable soft closing system ensuring the silent closing of the doors.

IMPRO Adjustable Soft-Close Hinge Series was designed with advanced technology and produced using a fully automated robotic production system together with new generation methods.

IMPRO Adjustable Soft-Close Hinge has proved its high performance globally, its quality being certified by LGA, one of the most important standardization institute in Germany. Also impro has been certified by FIRA in the UK

Soft Close 3D Adjustable 5 Speed Hinge

impro

NO	CODE	DEFINITION/FEATURE	UNIT	MRP	PACKAGE CONTENT
1	IH0CSC	Soft Close clip on 3D Impro 0 crank with 5mm mounting plate	Pair	635.00	50 Set
2	IH9CSC	Soft Close clip on 3D Impro 9 crank with 5mm mounting plate	Pair	695.00	50 Set
3	IH18CSC	Soft Close clip on 3D Impro 18 crank with 7mm mounting plate	Pair	790.00	50 Set

Soft Close 3D Adjustable Hinge

MASTER

NO	CODE	DEFINITION/FEATURE	UNIT	MRP	PACKAGE CONTENT
1	MH0CSC	Soft Close clip on 3D Master 0 crank with 5mm mounting plate	Pair	443.00	50 Set
2	MH9CSC	Soft Close clip on 3D Master 9 crank with 5mm mounting plate	Pair	473.00	50 Set
3	MH18CSC	Soft Close clip on 3D Master 18 crank with 7mm mounting plate	Pair	503.00	50 Set

Soft Close 4 Hole Mounting Plate Hinge

MASTER ^{NEW}

NO	CODE	DEFINITION/FEATURE	UNIT	MRP	PACKAGE CONTENT
1	PPH0CSC	Soft Close Clip On Prime Pack Master 0 Crank With 5mm Mounting Plate	Pair	285.00	50 Set
2	PPH9CSC	Soft Close Clip On Prime Pack Master 9 Crank With 5mm Mounting Plate	Pair	300.00	50 Set
3	PPH18CSC	Soft Close Clip On Prime Pack Master 18 Crank With 7mm Mounting Plate	Pair	315.00	50 Set

Clip on 3D Adjustable Hinge

STAR TRACK

NO	CODE	DEFINITION/FEATURE	UNIT	MRP	CONTENT
1	STH0C	Clip on Star Track 3D hinge 0 crank with 5mm mounting plate	Pair	242.00	20 Set
2	STH9C	Clip on Star Track 3D hinge 9 crank with 5mm mounting plate	Pair	255.00	20 Set
3	STH18C	Clip on Star Track 3D hinge 18 crank with 7mm mounting plate	Pair	259.00	20 Set

Slide On Hinge

STAR

NO	CODE	DEFINITION/FEATURE	UNIT	MRP	CONTENT
1	SH0C	Slide on Star hinge 0 crank with 5mm mounting plate	Pair	99.00	50 Set
2	SH9C	Slide on Star hinge 9 crank with 5mm mounting plate	Pair	105.00	50 Set
3	SH18C	Slide on Star hinge 18 crank with 7mm mounting plate	Pair	110.00	50 Set

Slide on 90° Hinge

STAR

NO	CODE	DEFINITION/FEATURE	UNIT	MRP	CONTENT
1	SHBC900C	Blind corner Hinge face angle 90 degree with 5mm mounting plate	Pair	725.00	20 Set

Clip On 165° Soft Close Hinge



NO	CODE	DEFINITION/FEATURE	UNIT	MRP	PACKAGE CONTENT
1	SHPC165SC0C	Soft Close Clip On 3d Pi Corner Hinge Opening Angle 165 Degree With Mounting Plate	Pair	1,260.00	20 Set

Clip On 90° Soft Close Hinge



NO	CODE	DEFINITION/FEATURE	UNIT	MRP	CONTENT
1	SHBC90SC0C	Blind corner Soft close 3D Hinge face angle 90 degree with 5mm mounting plate	Pair	1,225.00	20 Set

Slide On Hinge 165°

STAR



NO	CODE	DEFINITION/FEATURE	UNIT	MRP	CONTENT
1	SHPC1650C	Pi Corner Hinge Opening Angle 165 Degree With Mounting Plate	Pair	810.00	20 Set

Star Push Open Hinge Without Spring

STAR



NO	CODE	DEFINITION/FEATURE	UNIT	MRP	PACKAGE CONTENT
1	SHPO0C	Push Open Star Hinge Without Spring 0 Crank With Mounting Plate	Pair	129.00	20 Set
2	SHPO9C	Push Open Star Hinge Without Spring 9 Crank With Mounting Plate	Pair	150.00	20 Set
3	SHPO18C	Push Open Star Hinge Without Spring 18 Crank With Mounting Plate	Pair	175.00	20 Set

Push-open Long Latch



NO	CODE	DEFINITION/FEATURE	UNIT	MRP	PACKAGE CONTENT
1	SHPLL	Push-open Long Latch	Pc	325.00	20 Set
2	SHPOLM	Push-open Long Latch Counter Piece Magnet	Pc	14.00	20 Set

Push-open Long Latch Adapter



NO	CODE	DEFINITION/FEATURE	UNIT	MRP	PACKAGE CONTENT
1	SHPOA	Push-open Long Latch Adapter	Pc	139.00	20 Set

Clip On Folding Door Hinge

STAR TRACK



NO	CODE	DEFINITION/FEATURE	UNIT	MRP	PACKAGE CONTENT
1	SHFDHOC	Bi-fold Clip On Star Track Folding Door Hinge With 5mm Mounting Plate	Pair	762.00	20 Set

Clip On Hinge For Thick Doors / Cabinet Side Hinge

STAR TRACK



NO	CODE	DEFINITION/FEATURE	UNIT	MRP	PACKAGE CONTENT
1	SHCOTDOC	Thick Door Clip On 3d Star Track Hinge 0 Crank (upto 43 Mm Shutter Thickness)	Pair	255.00	20 Set
2	SHCOTD9C	Thick Door Clip On 3d Star Track Hinge 7 Crank (upto 43 Mm Shutter Thickness)	Pair	280.00	20 Set
3	SHCOTD18C	Thick Door Clip On 3d Star Track Hinge 16 Crank (upto 43 Mm Shutter Thickness)	Pair	287.00	20 Set

Add On Soft Close Mechanism For Hinge

STAR TRACK



NO	CODE	DEFINITION/FEATURE	UNIT	MRP	PACKAGE CONTENT
1	SHAOSCO0C	Star Track Add On Soft Close Mechanism 0 Crank	Pc	195.00	20 Pcs
2	SHAOSCO9C	Star Track Add On Soft Close Mechanism 9 Crank	Pc	195.00	20 Pcs
3	SHAOSCO18C	Star Track Add On Soft Close Mechanism 18 Crank	Pc	195.00	20 Pcs



smart slide

DRAWER SLIDE SYSTEM

Under Mount Slide Full Extension Soft Close Drawer Lock-fix

smart slide



NO	CODE	DEFINITION/FEATURE	UNIT	MRP	PACKAGE CONTENT
1	SSUM250	Smart Slide Synchronised Full Extension Soft Close 40 Kg, 250 mm	Set	1,950.00	6 Set
2	SSUM300	Smart Slide Synchronised Full Extension Soft Close 40 Kg, 300 mm	Set	1,950.00	6 Set
3	SSUM350	Smart Slide Synchronised Full Extension Soft Close 40 Kg, 350 mm	Set	1,950.00	6 Set
4	SSUM400	Smart Slide Synchronised Full Extension Soft Close 40 Kg, 400 mm	Set	1,980.00	6 Set
5	SSUM450	Smart Slide Synchronised Full Extension Soft Close 40 Kg, 450 mm	Set	2,000.00	6 Set
6	SSUM500	Smart Slide Synchronised Full Extension Soft Close 40 Kg, 500 mm	Set	2,100.00	6 Set
7	SSUM550	Smart Slide Synchronised Full Extension Soft Close 40 Kg, 550 mm	Set	2,300.00	6 Set
8	SSUM600	Smart Slide Synchronised Full Extension Soft Close 40 Kg, 600 mm	Set	2,400.00	6 Set

Under Mount Slide Push-open Soft Close Full Extension Lock-fix

smart slide



NO	CODE	DEFINITION/FEATURE	UNIT	MRP	PACKAGE CONTENT
1	SSUMPOSC350	Smart Slide Synchronised Push Open Soft Close Full Extension 40 Kg, 350 mm	Set	2,606.00	6 Set
2	SSUMPOSC400	Smart Slide Synchronised Push Open Soft Close Full Extension 40 Kg, 400 mm	Set	2,827.00	6 Set
3	SSUMPOSC450	Smart Slide Synchronised Push Open Soft Close Full Extension 40 Kg, 450 mm	Set	2,938.00	6 Set
4	SSUMPOSC500	Smart Slide Synchronised Push Open Soft Close Full Extension 40 Kg, 500 mm	Set	3,170.00	6 Set
5	SSUMPOSC550	Smart Slide Synchronised Push Open Soft Close Full Extension 40 Kg, 550 mm	Set	3,390.00	6 Set
6	SSUMPOSC600	Smart Slide Synchronised Push Open Soft Close Full Extension 40 Kg, 600 mm	Set	3,751.00	6 Set

Smart Slide Distance Bracket

smart slide

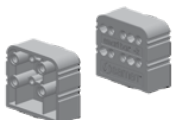

NO	CODE	DEFINITION/FEATURE	UNIT	MRP	PACKAGE CONTENT
1	SSDBR	Smart Distance Bracket Right 25mm	Pc	113.00	10 Pcs
2	SSDBL	Smart Distance Bracket Left 25mm	Pc	113.00	10 Pcs

Smart Slide Smart Lock Template

smart slide



NO	CODE	DEFINITION/FEATURE	UNIT	MRP	PACKAGE CONTENT
1	SSLCT	Smart Slide Lock Clip Template	Pc	113.00	10 Pcs

Ball Bearing Full Extension Slide - 46 mm [45 KG]

SO CLASS



NO	CODE	DEFINITION/FEATURE	UNIT	MRP	PACKAGE CONTENT
1	SOBB250	SO Class Ball Bearing Slides Zinc 46 - 250 mm	Set	358.00	12 Set
2	SOBB300	SO Class Ball Bearing Slides Zinc 46 - 300 mm	Set	387.00	12 Set
3	SOBB350	SO Class Ball Bearing Slides Zinc 46 - 350 mm	Set	425.00	12 Set
4	SOBB400	SO Class Ball Bearing Slides Zinc 46 - 400 mm	Set	447.00	12 Set
5	SOBB450	SO Class Ball Bearing Slides Zinc 46 - 450 mm	Set	482.00	12 Set
6	SOBB500	SO Class Ball Bearing Slides Zinc 46 - 500 mm	Set	493.00	12 Set
7	SOBB550	SO Class Ball Bearing Slides Zinc 46 - 550 mm	Set	541.00	12 Set
8	SOBB600	SO Class Ball Bearing Slides Zinc 46 - 600 mm	Set	578.00	12 Set
9	SOBB650	SO Class Ball Bearing Slides Zinc 46 - 650 mm	Set	693.00	12 Set
10	SOBB700	SO Class Ball Bearing Slides Zinc 46 - 700 mm	Set	788.00	12 Set
11	SOBB250BL	SO Class Ball Bearing Slides Black 46 - 250 mm	Set	358.00	12 Set
12	SOBB300BL	SO Class Ball Bearing Slides Black 46 - 300 mm	Set	387.00	12 Set
13	SOBB350BL	SO Class Ball Bearing Slides Black 46 - 350 mm	Set	425.00	12 Set
14	SOBB400BL	SO Class Ball Bearing Slides Black 46 - 400 mm	Set	447.00	12 Set
15	SOBB450BL	SO Class Ball Bearing Slides Black 46 - 450 mm	Set	482.00	12 Set
16	SOBB500BL	SO Class Ball Bearing Slides Black 46 - 500 mm	Set	493.00	12 Set
17	SOBB550BL	SO Class Ball Bearing Slides Black 46 - 550 mm	Set	541.00	12 Set
18	SOBB600BL	SO Class Ball Bearing Slides Black 46 - 600 mm	Set	578.00	12 Set
19	SOBB650BL	SO Class Ball Bearing Slides Black 46 - 650 mm	Set	693.00	12 Set
20	SOBB700BL	SO Class Ball Bearing Slides Black 46 - 700 mm	Set	788.00	12 Set

Ball Bearing Full Extension Slide Soft Close - 46 mm [30 KG]

SO CLASS



NO	CODE	DEFINITION/FEATURE	UNIT	MRP	PACKAGE CONTENT
1	SOBBSC300	SO Class Soft close Ball Bearing Slides Zinc 46 - 300 mm	Set	962.00	12 Set
2	SOBBSC350	SO Class Soft close Ball Bearing Slides Zinc 46 - 350 mm	Set	984.00	12 Set
3	SOBBSC400	SO Class Soft close Ball Bearing Slides Zinc 46 - 400 mm	Set	1,010.00	12 Set
4	SOBBSC450	SO Class Soft close Ball Bearing Slides Zinc 46 - 450 mm	Set	1,042.00	12 Set
5	SOBBSC500	SO Class Soft close Ball Bearing Slides Zinc 46 - 500 mm	Set	1,070.00	12 Set
6	SOBBSC550	SO Class Soft close Ball Bearing Slides Zinc 46 - 550 mm	Set	1,105.00	12 Set
7	SOBBSC600	SO Class Soft close Ball Bearing Slides Zinc 46 - 600 mm	Set	1,277.00	12 Set
8	SOBBSC650	SO Class Soft close Ball Bearing Slides Zinc 46 - 650 mm	Set	1,370.00	12 Set
9	SOBBSC700	SO Class Soft close Ball Bearing Slides Zinc 46 - 700 mm	Set	1,463.00	12 Set
10	SOBBSC300BL	SO Class Soft close Ball Bearing Slides Black 46 - 300 mm	Set	962.00	12 Set
11	SOBBSC350BL	SO Class Soft close Ball Bearing Slides Black 46 - 350 mm	Set	984.00	12 Set
12	SOBBSC400BL	SO Class Soft close Ball Bearing Slides Black 46 - 400 mm	Set	1,010.00	12 Set
13	SOBBSC450BL	SO Class Soft close Ball Bearing Slides Black 46 - 450 mm	Set	1,042.00	12 Set
14	SOBBSC500BL	SO Class Soft close Ball Bearing Slides Black 46 - 500 mm	Set	1,070.00	12 Set
15	SOBBSC550BL	SO Class Soft close Ball Bearing Slides Black 46 - 550 mm	Set	1,105.00	12 Set
16	SOBBSC600BL	SO Class Soft close Ball Bearing Slides Black 46 - 600 mm	Set	1,277.00	12 Set
17	SOBBSC650BL	SO Class Soft close Ball Bearing Slides Black 46 - 650 mm	Set	1,370.00	12 Set
18	SOBBSC700BL	SO Class Soft close Ball Bearing Slides Black 46 - 700 mm	Set	1,463.00	12 Set

SMARTFLOW

DRAWER SYSTEM



Touch the
High-end
Design and
Functionality!

- > 12,8 mm ultra thin and elegant side design
- > Flexible solutions with two different side height and unlimited gallery railing usage
- > Enriched superior design combined with various seductive colour themes
- > Smooth and silent movement technology with improved synchronisation
- > Soft close and push-open soft close functions

Slim Drawer System: H:58 Drawer

SMARTFLOW

NO	CODE	DEFINITION/FEATURE	UNIT	MRP	PACKAGE CONTENT
1	SF58400AN	Smart Flow 18mm, Anthracite 400mm, Height 58/87mm, 40 Kg	Set	4,414.00	1 Set
2	SF58450AN	Smart Flow 18mm, Anthracite 450mm, Height 58/87mm, 40 Kg	Set	4,414.00	1 Set
3	SF58500AN	Smart Flow 18mm, Anthracite 500mm, Height 58/87mm, 40 Kg	Set	4,414.00	1 Set
4	SF58550AN	Smart Flow 18mm, Anthracite 550mm, Height 58/87mm, 40 Kg	Set	4,584.00	1 Set
5	SF58600AN	Smart Flow 18mm, Anthracite 600mm, Height 58/87mm, 40 Kg	Set	4,715.00	1 Set
6	SF58400SI	Smart Flow 18mm, Silver 400mm Height 58/87mm, 40 Kg	Set	4,242.00	1 Set
7	SF58450SI	Smart Flow 18mm, Silver 450mm Height 58/87mm, 40 Kg	Set	4,242.00	1 Set
8	SF58500SI	Smart Flow 18mm, Silver 500mm Height 58/87mm, 40 Kg	Set	4,242.00	1 Set
9	SF58550SI	Smart Flow 18mm, Silver 550mm Height 58/87mm, 40 Kg	Set	4,414.00	1 Set
10	SF58600SI	Smart Flow 18mm, Silver 600mm Height 58/87mm, 40 Kg	Set	4,414.00	1 Set
11	SF58400MO	Smart Flow 18mm, Mocha 400mm Height 58/87mm, 40 Kg	Set	4,414.00	1 Set
12	SF58450MO	Smart Flow 18mm, Mocha 450mm Height 58/87mm, 40 Kg	Set	4,414.00	1 Set
13	SF58500MO	Smart Flow 18mm, Mocha 500mm Height 58/87mm, 40 Kg	Set	4,414.00	1 Set
14	SF58550MO	Smart Flow 18mm, Mocha 550mm Height 58/87mm, 40 Kg	Set	4,584.00	1 Set
15	SF58600MO	Smart Flow 18mm, Mocha 600mm Height 58/87mm, 40 Kg	Set	4,584.00	1 Set
16	SF58POSC400AN	Smart Flow 18mm, Push To Open Soft Close Anthracite 400mm Height 58/87mm, 40 Kg	Set	4,988.00	1 Set
17	SF58POSC450AN	Smart Flow 18mm, Push To Open Soft Close Anthracite 450mm Height 58/87mm, 40 Kg	Set	4,988.00	1 Set
18	SF58POSC500AN	Smart Flow 18mm, Push To Open Soft Close Anthracite 500mm Height 58/87mm, 40 Kg	Set	4,988.00	1 Set
19	SF58POSC550AN	Smart Flow 18mm, Push To Open Soft Close Anthracite 550mm Height 58/87mm, 40 Kg	Set	5,180.00	1 Set
20	SF58POSC600AN	Smart Flow 18mm, Push To Open Soft Close Anthracite 600mm Height 58/87mm, 40 Kg	Set	5,180.00	1 Set
21	SF58POSC400SI	Smart Flow 18mm, Push To Open Soft Close Silver 400mm Height 58/87mm, 40 Kg	Set	4,794.00	1 Set
22	SF58POSC450SI	Smart Flow 18mm, Push To Open Soft Close Silver 450mm Height 58/87mm, 40 Kg	Set	4,794.00	1 Set
23	SF58POSC500SI	Smart Flow 18mm, Push To Open Soft Close Silver 500mm Height 58/87mm, 40 Kg	Set	4,794.00	1 Set
24	SF58POSC550SI	Smart Flow 18mm, Push To Open Soft Close Silver 550mm Height 58/87mm, 40 Kg	Set	4,988.00	1 Set
25	SF58POSC600SI	Smart Flow 18mm, Push To Open Soft Close Silver 600mm Height 58/87mm, 40 Kg	Set	4,988.00	1 Set
26	SF58POSC400MO	Smart Flow 18mm, Push To Open Soft Close Mocha 400mm Height 58/87mm, 40 Kg	Set	4,988.00	1 Set
27	SF58POSC450MO	Smart Flow 18mm, Push To Open Soft Close Mocha 450mm Height 58/87mm, 40 Kg	Set	4,988.00	1 Set
28	SF58POSC500MO	Smart Flow 18mm, Push To Open Soft Close Mocha 500mm Height 58/87mm, 40 Kg	Set	4,988.00	1 Set
29	SF58POSC550MO	Smart Flow 18mm, Push To Open Soft Close Mocha 550mm Height 58/87mm, 40 Kg	Set	5,180.00	1 Set
30	SF58POSC600MO	Smart Flow 18mm, Push To Open Soft Close Mocha 600mm Height 58/87mm, 40 Kg	Set	5,180.00	1 Set

Slim Drawer System: H:144 Drawer

SMARTFLOW

NO	CODE	DEFINITION/FEATURE	UNIT	MRP	PACKAGE CONTENT
1	SF144400AN	Smart Flow 18mm, Anthracite 400mm Height 144/170mm, 40 Kg	Set	5,694.00	1 Set
2	SF144450AN	Smart Flow 18mm, Anthracite 450mm Height 144/170mm, 40 Kg	Set	5,694.00	1 Set
3	SF144500AN	Smart Flow 18mm, Anthracite 500mm Height 144/170mm, 40 Kg	Set	5,694.00	1 Set
4	SF144550AN	Smart Flow 18mm, Anthracite 550mm Height 144/170mm, 40 Kg	Set	5,914.00	1 Set
5	SF144600AN	Smart Flow 18mm, Anthracite 600mm Height 144/170mm, 40 Kg	Set	5,914.00	1 Set
6	SF144400SI	Smart Flow 18mm, Silver 400mm Height 144/170mm, 40 Kg	Set	5,473.00	1 Set
7	SF144450SI	Smart Flow 18mm, Silver 450mm Height 144/170mm, 40 Kg	Set	5,473.00	1 Set
8	SF144500SI	Smart Flow 18mm, Silver 500mm Height 144/170mm, 40 Kg	Set	5,473.00	1 Set
9	SF144550SI	Smart Flow 18mm, Silver 550mm Height 144/170mm, 40 Kg	Set	5,694.00	1 Set
10	SF144600SI	Smart Flow 18mm, Silver 600mm Height 144/170mm, 40 Kg	Set	5,694.00	1 Set
11	SF144400MO	Smart Flow 18mm, Mocha 400mm Height 144/170mm, 40 Kg	Set	5,694.00	1 Set
12	SF144450MO	Smart Flow 18mm, Mocha 450mm Height 144/170mm, 40 Kg	Set	5,694.00	1 Set
13	SF144500MO	Smart Flow 18mm, Mocha 500mm Height 144/170mm, 40 Kg	Set	5,694.00	1 Set
14	SF144550MO	Smart Flow 18mm, Mocha 550mm Height 144/170mm, 40 Kg	Set	5,914.00	1 Set
15	SF144600MO	Smart Flow 18mm, Mocha 600mm Height 144/170mm, 40 Kg	Set	5,914.00	1 Set
16	SF144POSC400AN	Smart Flow Push To Open Soft Close 18mm, Anthracite 400mm Height 144/170mm, 40 Kg	Set	6,377.00	1 Set
17	SF144POSC450AN	Smart Flow Push To Open Soft Close 18mm, Anthracite 450mm Height 144/170mm, 40 Kg	Set	6,377.00	1 Set
18	SF144POSC500AN	Smart Flow Push To Open Soft Close 18mm, Anthracite 500mm Height 144/170mm, 40 Kg	Set	6,377.00	1 Set
19	SF144POSC550AN	Smart Flow Push To Open Soft Close 18mm, Anthracite 550mm Height 144/170mm, 40 Kg	Set	6,622.00	1 Set
20	SF144POSC600AN	Smart Flow Push To Open Soft Close 18mm, Anthracite 600mm Height 144/170mm, 40 Kg	Set	6,622.00	1 Set
21	SF144POSC400SI	Smart Flow Push To Open Soft Close 18mm, Silver 400mm Height 144/170mm, 40 Kg	Set	6,130.00	1 Set
22	SF144POSC450SI	Smart Flow Push To Open Soft Close 18mm, Silver 450mm Height 144/170mm, 40 Kg	Set	6,130.00	1 Set
23	SF144POSC500SI	Smart Flow Push To Open Soft Close 18mm, Silver 500mm Height 144/170mm, 40 Kg	Set	6,130.00	1 Set
24	SF144POSC550SI	Smart Flow Push To Open Soft Close 18mm, Silver 550mm Height 144/170mm, 40 Kg	Set	6,377.00	1 Set
25	SF144POSC600SI	Smart Flow Push To Open Soft Close 18mm, Silver 600mm Height 144/170mm, 40 Kg	Set	6,377.00	1 Set
26	SF144POSC400MO	Smart Flow Push To Open Soft Close 18mm, Mocha 400mm Height 144/170mm, 40 Kg	Set	6,377.00	1 Set

NO	CODE	DEFINITION/FEATURE	UNIT	MRP	PACKAGE CONTENT
27	SF144POSC450MO	Smart Flow Push To Open Soft Close 18mm, Mocha 450mm Height 144/170mm, 40 Kg	Set	6,377.00	1 Set
28	SF144POSC500MO	Smart Flow Push To Open Soft Close 18mm, Mocha 500mm Height 144/170mm, 40 Kg	Set	6,377.00	1 Set
29	SF144POSC550MO	Smart Flow Push To Open Soft Close 18mm, Mocha 550mm Height 144/170mm, 40 Kg	Set	6,622.00	1 Set
30	SF144POSC600MO	Smart Flow Push To Open Soft Close 18mm, Mocha 600mm Height 144/170mm, 40 Kg	Set	6,622.00	1 Set

Slim Drawer System: Side Gallery Railing Bar

SMARTFLOW

NO	CODE	DEFINITION/FEATURE	UNIT	MRP	PACKAGE CONTENT
1	SFGLY400AN	Smart Flow Gallery Railing Bar Anthracite 400mm	Set	682.00	12 Set
2	SFGLY450AN	Smart Flow Gallery Railing Bar Anthracite 450mm	Set	704.00	12 Set
3	SFGLY500AN	Smart Flow Gallery Railing Bar Anthracite 500mm	Set	731.00	12 Set
4	SFGLY550AN	Smart Flow Gallery Railing Bar Anthracite 550mm	Set	766.00	12 Set
5	SFGLY600AN	Smart Flow Gallery Railing Bar Anthracite 600mm	Set	792.00	12 Set
6	SFGLY400SI	Smart Flow Gallery Railing Bar Silver 400mm	Set	610.00	12 Set
7	SFGLY450SI	Smart Flow Gallery Railing Bar Silver 450mm	Set	629.00	12 Set
8	SFGLY500SI	Smart Flow Gallery Railing Bar Silver 500mm	Set	657.00	12 Set
9	SFGLY550SI	Smart Flow Gallery Railing Bar Silver 550mm	Set	686.00	12 Set
10	SFGLY600SI	Smart Flow Gallery Railing Bar Silver 600mm	Set	704.00	12 Set
11	SFGLY400MO	Smart Flow Gallery Railing Bar Mocha 400mm	Set	682.00	12 Set
12	SFGLY450MO	Smart Flow Gallery Railing Bar Mocha 450mm	Set	704.00	12 Set
13	SFGLY500MO	Smart Flow Gallery Railing Bar Mocha 500mm	Set	731.00	12 Set
14	SFGLY550MO	Smart Flow Gallery Railing Bar Mocha 550mm	Set	766.00	12 Set
15	SFGLY600MO	Smart Flow Gallery Railing Bar Mocha 600mm	Set	792.00	12 Set

Slim Drawer System: In-Box Front Panel

SMARTFLOW

NO	CODE	DEFINITION/FEATURE	UNIT	MRP	PACKAGE CONTENT
1	SFFPWGAN	Smart Flow Inner Drawer 18mm - Front Panel Anthracite 1200mm	Pc	2,867.00	12 Pcs
2	SFFPWGSI	Smart Flow Inner Drawer 18mm - Front Panel Silver 1200 mm	Pc	2,867.00	12 Pcs
3	SFFPWGMO	Smart Flow Inner Drawer 18mm - Front Panel Mocha 1200 mm	Pc	2,867.00	12 Pcs
4	SFFPSGAN	Smart Flow Inner Drawer 18mm For Gallery - Front Panel Anthracite 1200mm	Pc	2,867.00	12 Pcs
5	SFFPSGSI	Smart Flow Inner Drawer 18mm For Gallery- Front Panel Silver 1200 mm	Pc	2,867.00	12 Pcs
6	SFFPSGMO	Smart Flow Inner Drawer 18mm For Gallery- Front Panel Mocha 1200 mm	Pc	2,867.00	12 Pcs

Slim Drawer System: In-Box Front Panel Holder

SMARTFLOW

NO	CODE	DEFINITION/FEATURE	UNIT	MRP	PACKAGE CONTENT
1	SFFCWGSI	Smart Flow Inner Drawer- Front Connector H 58 Without Gallery Silver	Set	843.00	12 Set
2	SFFCSGSI	Smart Flow Inner Drawer- Front Connector H 58 Single Gallery Silver	Set	1040.00	12 Set
3	SFFCWGAN	Smart Flow Inner Drawer- Front Connector H 58 Without Gallery Anthracite	Set	843.00	12 Set
4	SFFCSGAN	Smart Flow Inner Drawer- Front Connector H 58 Single Gallery Anthracite	Set	1040.00	12 Set
5	SFFCWGMO	Smart Flow Inner Drawer- Front Connector H 58 Without Gallery Mocha	Set	843.00	12 Set
6	SFFCSGMO	Smart Flow Inner Drawer- Front Connector H 58 Single Gallery Mocha	Set	1040.00	12 Set
7	SFFC144SI	Smart Flow Inner Drawer- Front Connector H 144 Without Gallery Silver	Set	1,087.00	12 Set
8	SFFC144AN	Smart Flow Inner Drawer- Front Connector H 144 Without Gallery Anthracite	Set	1,087.00	12 Set
9	SFFC144MO	Smart Flow Inner Drawer- Front Connector H 144 Without Gallery Mocha	Set	1,087.00	12 Set

Slim Drawer System: Metal Backpanel

SMARTFLOW

NO	CODE	DEFINITION/FEATURE	UNIT	MRP	PACKAGE CONTENT
1	SFBPWG600	Smart Flow Inner Drawer - Metal Backpanel Without Gallery Railing 600 mm	Pc	455.00	4 Pcs
2	SFBPWG900	Smart Flow Inner Drawer - Metal Backpanel Without Gallery Railing 900 mm	Pc	829.00	4 Pcs
3	SFBPGD600	Smart Flow Inner Drawer - Metal Backpanel With Gallery Railing 600 mm	Pc	908.00	4 Pcs

NO	CODE	DEFINITION/FEATURE	UNIT	MRP	PACKAGE CONTENT
4	SFBPGD900	Smart Flow Inner Drawer - Metal Backpanel With Gallery Railing 900 mm	Pc	1,422.00	4 Pcs

Slim Drawer System: Front Railing Bar

SMARTFLOW

NO	CODE	DEFINITION/FEATURE	UNIT	MRP	PACKAGE CONTENT
1	SFFPGDSI	Smart Flow Inner Drawer - Front Railing Bar 1200mm Silver	Pc	967.00	12 Pcs
2	SFFPGDAN	Smart Flow Inner Drawer - Front Railing Bar 1200mm Anthracite	Pc	967.00	12 Pcs
3	SFFPGDMO	Smart Flow Inner Drawer - Front Railing Bar 1200mm Mocha	Pc	967.00	12 Pcs

Slim Drawer System: Glass Side Panel

SMARTFLOW

NO	CODE	DEFINITION/FEATURE	UNIT	MRP	PACKAGE CONTENT
1	SFGP400SI	Smart Flow Glass Side Panel 400mm Silver	Set	1,386.00	1 Set
2	SFGP450SI	Smart Flow Glass Side Panel 450mm Silver	Set	1,386.00	1 Set
3	SFGP500SI	Smart Flow Glass Side Panel 500mm Silver	Set	1,448.00	1 Set
4	SFGP550SI	Smart Flow Glass Side Panel 550mm Silver	Set	1,473.00	1 Set
5	SFGP400AN	Smart Flow Glass Side Panel 400mm Anthracite	Set	1,386.00	1 Set
6	SFGP450AN	Smart Flow Glass Side Panel 450mm Anthracite	Set	1,386.00	1 Set
7	SFGP500AN	Smart Flow Glass Side Panel 500mm Anthracite	Set	1,448.00	1 Set
8	SFGP550AN	Smart Flow Glass Side Panel 550mm Anthracite	Set	1,473.00	1 Set
9	SFGP400MO	Smart Flow Glass Side Panel 400mm Mocha	Set	1,386.00	1 Set
10	SFGP450MO	Smart Flow Glass Side Panel 450mm Mocha	Set	1,386.00	1 Set
11	SFGP500MO	Smart Flow Glass Side Panel 500mm Mocha	Set	1,448.00	1 Set
12	SFGP550MO	Smart Flow Glass Side Panel 550mm Mocha	Set	1,473.00	1 Set

Drawer System: H68 Drawer Without Gallery Railing

smart box

NO	CODE	DEFINITION/FEATURE	UNIT	MRP	PACKAGE CONTENT
1	SB35040GR	Smart Box 18mm Grey 350mm, Height 68/97mm, 40 Kg	Set	4,038.00	1 Set
2	SB40040GR	Smart Box 18mm Grey 400mm Height 68/97mm, 40 Kg	Set	4,038.00	1 Set
3	SB45040GR	Smart Box 18mm Grey 450mm Height 68/97mm, 40 Kg	Set	3,660.00	1 Set
4	SB50040GR	Smart Box 18mm Grey 500mm Height 68/97mm, 40 Kg	Set	3,852.00	1 Set
5	SB55040GR	Smart Box 18mm Grey 550mm Height 68/97mm, 40 Kg	Set	4,042.00	1 Set
6	SB60040GR	Smart Box 18mm Grey 600mm Height 68/97mm, 40 Kg	Set	4,246.00	1 Set
7	SB35040WH	Smart Box 18mm White 350mm Height 68/97mm, 40 Kg	Set	4,250.00	1 Set
8	SB40040WH	Smart Box 18mm White 400mm Height 68/97mm, 40 Kg	Set	4,250.00	1 Set
9	SB45040WH	Smart Box 18mm White 450mm Height 68/97mm, 40 Kg	Set	3,852.00	1 Set
10	SB50040WH	Smart Box 18mm White 500mm Height 68/97mm, 40 Kg	Set	4,033.00	1 Set
11	SB55040WH	Smart Box 18mm White 550mm Height 68/97mm, 40 Kg	Set	4,233.00	1 Set
12	SB60040WH	Smart Box 18mm White 600mm Height 68/97mm, 40 Kg	Set	4,447.00	1 Set
13	SB45065GR	Smart Box 18mm Grey 450mm Height 68/97mm, 65 Kg	Set	4,414.00	1 Set
14	SB50065GR	Smart Box 18mm Grey 500mm Height 68/97mm, 65 Kg	Set	4,604.00	1 Set
15	SB55065GR	Smart Box 18mm Grey 550mm Height 68/97mm, 65 Kg	Set	4,835.00	1 Set
16	SB60065GR	Smart Box 18mm Grey 600mm Height 68/97mm, 65 Kg	Set	5,165.00	1 Set
17	SB45065WH	Smart Box 18mm White 450mm Height 68/97mm, 65 Kg	Set	4,593.00	1 Set
18	SB50065WH	Smart Box 18mm White 500mm Height 68/97mm, 65 Kg	Set	4,785.00	1 Set
19	SB55065WH	Smart Box 18mm White 550mm Height 68/97mm, 65 Kg	Set	5,025.00	1 Set
20	SB60065WH	Smart Box 18mm White 600mm Height 68/97mm, 65 Kg	Set	5,367.00	1 Set

Drawer System: Gallery Railing Bar

smart box

NO	CODE	DEFINITION/FEATURE	UNIT	MRP	PACKAGE CONTENT
1	SBGLY350GR	Smart Box Gallery Railing Bar Grey 350mm	Set	630.00	20 Set

NO	CODE	DEFINITION/FEATURE	UNIT	MRP	PACKAGE CONTENT
2	SBGLY400GR	Smart Box Gallery Railing Bar Grey 400mm	Set	645.00	20 Set
3	SBGLY450GR	Smart Box Gallery Railing Bar Grey 450mm	Set	661.00	20 Set
4	SBGLY500GR	Smart Box Gallery Railing Bar Grey 500mm	Set	682.00	20 Set
5	SBGLY550GR	Smart Box Gallery Railing Bar Grey 550mm	Set	687.00	20 Set
6	SBGLY600GR	Smart Box Gallery Railing Bar Grey 600mm	Set	697.00	20 Set
7	SBGLY350WH	Smart Box Gallery Railing Bar White 350mm	Set	639.00	20 Set
8	SBGLY400WH	Smart Box Gallery Railing Bar White 400mm	Set	656.00	20 Set
9	SBGLY450WH	Smart Box Gallery Railing Bar White 450mm	Set	671.00	20 Set
10	SBGLY500WH	Smart Box Gallery Railing Bar White 500mm	Set	692.00	20 Set
11	SBGLY550WH	Smart Box Gallery Railing Bar White 550mm	Set	703.00	20 Set
12	SBGLY600WH	Smart Box Gallery Railing Bar White 600mm	Set	714.00	20 Set

Drawer System: Metal Side Panel

NO	CODE	DEFINITION/FEATURE	UNIT	MRP	PACKAGE CONTENT
1	SBSD450GR	Smart Box Drawer Metal Side Grey 450mm	Set	819.00	10 Set
2	SBSD500GR	Smart Box Drawer Metal Side Grey 500mm	Set	869.00	10 Set
3	SBSD550GR	Smart Box Drawer Metal Side Grey 550mm	Set	929.00	10 Set
4	SBSD600GR	Smart Box Drawer Metal Side Grey 600mm	Set	979.00	10 Set

Drawer System: Backboard Holder

NO	CODE	DEFINITION/FEATURE	UNIT	MRP	PACKAGE CONTENT
1	SBHSGGR	Smart Box Back Board Holder Grey Single Gallery 18mm	Set	49.00	4 Set
2	SBHDGGR	Smart Box Back Board Holder Grey Double Gallery 18mm	Set	98.00	4 Set
3	SBHSGWH	Smart Box Back Board Holder White Single Gallery 18mm	Set	49.00	4 Set
4	SBHDGWH	Smart Box Back Board Holder White Double Gallery 18mm	Set	98.00	4 Set

Drawer System: In-Box Front Gallery

smart box

NO	CODE	DEFINITION/FEATURE	UNIT	MRP	PACKAGE CONTENT
1	SBIDFGGR	Smart Box Inner Drawer Front Gallery Grey 1115mm	Pc	730.00	10 Pcs
2	SBIDFGWH	Smart Box Inner Drawer Front Gallery White 1115mm	Pc	730.00	10 Pcs

Drawer System: In-Box Front Panel

smart box

NO	CODE	DEFINITION/FEATURE	UNIT	MRP	PACKAGE CONTENT
1	SBIDFPWH	Smart Box Inner Drawer Front Panel White 1069mm	Pc	2,825.00	10 Pcs
2	SBIDFPGR	Smart Box Inner Drawer Front Panel Grey 1069mm	Pc	2,825.00	10 Pcs

Drawer System: In-Box Metal Back Panel

smart box

NO	CODE	DEFINITION/FEATURE	UNIT	MRP	PACKAGE CONTENT
1	SBBP48600GR	Smart Box Inner Drawer 48mm Metal Back Panel 600mm Grey	Pc	455.00	4 Pcs
2	SBBP48900GR	Smart Box Inner Drawer 48mm Metal Back Panel 900mm Grey	Pc	810.00	4 Pcs
3	SBBP112600GR	Smart Box Inner Drawer 112mm Metal Back Panel 600mm Grey	Pc	904.00	4 Pcs
4	SBBP112900GR	Smart Box Inner Drawer 112mm Metal Back Panel 900mm Grey	Pc	1,398.00	4 Pcs

Drawer System: In-Box Front Panel Connector

smart box

NO	CODE	DEFINITION/FEATURE	UNIT	MRP	PACKAGE CONTENT
1	SBFCWGGR	Smart Box Inner Drawer Front Connector Without Gallery Grey	Set	375.00	10 Set
2	SBFCSGGR	Smart Box Inner Drawer Front Connector Single Gallery Grey	Set	660.00	10 Set
3	SBFCDGGR	Smart Box Inner Drawer Front Connector Double Gallery Grey	Set	989.00	10 Set
4	SBFCWGWH	Smart Box Inner Drawer Front Connector Without Gallery White	Set	375.00	10 Set
5	SBFCSGWH	Smart Box Inner Drawer Front Connector Single Gallery White	Set	660.00	10 Set
6	SBFCDGWH	Smart Box Inner Drawer Front Connector Double Gallery White	Set	989.00	10 Set

Smartbox Sink Cabinet Drawer With Gallery Railing

smart box



NO	CODE	DEFINITION/FEATURE	UNIT	MRP	PACKAGE CONTENT
1	SBSC500GR	Smart Box Sink Cabinet With Gallery Railing Grey 500mm W900-1200	Set	13,190.00	1 Set
2	SBSC500WH	Smart Box Sink Cabinet With Gallery Railing White 500mm W900-1200	Set	13,190.00	1 Set

Drawer System: Front Stabilizer

smart box

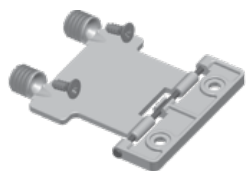

NO	CODE	DEFINITION/FEATURE	UNIT	MRP	PACKAGE CONTENT
1	SBFS	Smart Box Drawer System Front Stabilizer	Pc	280.00	20 Pcs

alphabox

DRAWER SYSTEM



Drawer System: H68 Drawer Without Gallery Railing

alphabox ^{NEW}

NO	CODE	DEFINITION/FEATURE	UNIT	MRP	PACKAGE CONTENT
1	AB350WH	Alpha Box 18mm White 350mm, Height 68/97mm, 40 Kg	Set	3,039.00	1 Set
2	AB400WH	Alpha Box 18mm White 400mm, Height 68/97mm, 40 Kg	Set	3,039.00	1 Set
3	AB450WH	Alpha Box 18mm White 450mm, Height 68/97mm, 40 Kg	Set	3,039.00	1 Set
4	AB500WH	Alpha Box 18mm White 500mm, Height 68/97mm, 40 Kg	Set	3,039.00	1 Set
5	AB350GR	Alpha Box 18mm Grey 350mm, Height 68/97mm, 40 Kg	Set	3,039.00	1 Set
6	AB400GR	Alpha Box 18mm Grey 400mm, Height 68/97mm, 40 Kg	Set	3,039.00	1 Set
7	AB450GR	Alpha Box 18mm Grey 450mm, Height 68/97mm, 40 Kg	Set	3,039.00	1 Set
8	AB500GR	Alpha Box 18mm Grey 500mm, Height 68/97mm, 40 Kg	Set	3,039.00	1 Set
9	AB350AN	Alpha Box 18mm Anthracite 350mm, Height 68/97mm, 40 Kg	Set	3,039.00	1 Set
10	AB400AN	Alpha Box 18mm Anthracite 400mm, Height 68/97mm, 40 Kg	Set	3,039.00	1 Set
11	AB450AN	Alpha Box 18mm Anthracite 450mm, Height 68/97mm, 40 Kg	Set	3,039.00	1 Set
12	AB500AN	Alpha Box 18mm Anthracite 500mm, Height 68/97mm, 40 Kg	Set	3,039.00	1 Set

Slim Drawer System: Side Gallery Railing Bar

alphabox ^{NEW}

NO	CODE	DEFINITION/FEATURE	UNIT	MRP	PACKAGE CONTENT
1	ABGLY350WH	Alpha Box Gallery Railing Bar White 350mm	Set	615.00	12 Set
2	ABGLY400WH	Alpha Box Gallery Railing Bar White 400mm	Set	615.00	12 Set
3	ABGLY450WH	Alpha Box Gallery Railing Bar White 450mm	Set	615.00	12 Set
4	ABGLY500WH	Alpha Box Gallery Railing Bar White 500mm	Set	615.00	12 Set
5	ABGLY350GR	Alpha Box Gallery Railing Bar Grey 350mm	Set	615.00	12 Set
6	ABGLY400GR	Alpha Box Gallery Railing Bar Grey 400mm	Set	615.00	12 Set
7	ABGLY450GR	Alpha Box Gallery Railing Bar Grey 450mm	Set	615.00	12 Set
8	ABGLY500GR	Alpha Box Gallery Railing Bar Grey 500mm	Set	615.00	12 Set
9	ABGLY350AN	Alpha Box Gallery Railing Bar Anthracite 350mm	Set	615.00	12 Set
10	ABGLY400AN	Alpha Box Gallery Railing Bar Anthracite 400mm	Set	615.00	12 Set
11	ABGLY450AN	Alpha Box Gallery Railing Bar Anthracite 450mm	Set	615.00	12 Set
12	ABGLY500AN	Alpha Box Gallery Railing Bar Anthracite 500mm	Set	615.00	12 Set

Drawer System: In-Box Front Panel

alphabox ^{NEW}

NO	CODE	DEFINITION/FEATURE	UNIT	MRP	PACKAGE CONTENT
1	ABFPWGGR	Alpha Box Inner Drawer 18mm - Front Panel Grey 1200mm	Pc	2,595.00	4 Pcs
2	ABFPSGGR	Alpha Box Inner Drawer 18mm For Gallery- Front Panel Grey 1200mm	Pc	2,595.00	4 Pcs

Drawer System: Front Railing Bar

alphabox ^{NEW}

NO	CODE	DEFINITION/FEATURE	UNIT	MRP	PACKAGE CONTENT
1	ABFPGDGR	Alpha Box Inner Drawer 18mm - Front Panel Gallery Design Grey 1200mm	Pc	710.00	4 Pcs

Slim Drawer System: Metal Backpanel

alphabox ^{NEW}

NO	CODE	DEFINITION/FEATURE	UNIT	MRP	PACKAGE CONTENT
1	ABBPWG600	Alpha Box Inner Drawer - Metal Back Panel Without Gallery Railing 600mm	Pc	590.00	4 Pcs
2	ABBPWG900	Alpha Box Inner Drawer - Metal Back Panel Without Gallery Railing 900mm	Pc	875.00	4 Pcs
3	ABBP6D600	Alpha Box Inner Drawer - Metal Back Panel With Gallery Railing 600mm	Pc	830.00	4 Pcs
2	ABBP6D900	Alpha Box Inner Drawer - Metal Back Panel With Gallery Railing 900mm	Pc	1,230.00	4 Pcs

Slim Drawer System: In-Box Front Panel Holder

alphabox ^{NEW}

NO	CODE	DEFINITION/FEATURE	UNIT	MRP	PACKAGE CONTENT
1	ABFCWGGR	Alpha Box Inner Drawer - Front Connector Without Gallery Grey	Set	620.00	4 Set
2	ABFCSGGR	Alpha Box Inner Drawer - Front Connector Single Gallery Grey	Set	760.00	4 Set

Slim Drawer System: Glass Side Panel

alphabox ^{NEW}

NO	CODE	DEFINITION/FEATURE	UNIT	MRP	PACKAGE CONTENT
1	ABGP400WH	Alpha Box Glass Slide Panel 400mm White	Set	1,300.00	1 Set
2	ABGP450WH	Alpha Box Glass Slide Panel 450mm White	Set	1,300.00	1 Set
3	ABGP500WH	Alpha Box Glass Slide Panel 500mm White	Set	1,300.00	1 Set
4	ABGP400GR	Alpha Box Glass Slide Panel 400mm Grey	Set	1,300.00	1 Set
5	ABGP450GR	Alpha Box Glass Slide Panel 450mm Grey	Set	1,300.00	1 Set
6	ABGP500GR	Alpha Box Glass Slide Panel 500mm Grey	Set	1,300.00	1 Set
7	ABGP400AN	Alpha Box Glass Slide Panel 400mm Anthracite	Set	1,300.00	1 Set
8	ABGP450AN	Alpha Box Glass Slide Panel 450mm Anthracite	Set	1,300.00	1 Set
9	ABGP500AN	Alpha Box Glass Slide Panel 500mm Anthracite	Set	1,300.00	1 Set



Drawer System: Roll Box Soft Close

ROLLBOX



NO	CODE	DEFINITION/FEATURE	UNIT	MRP	PACKAGE CONTENT
1	RB450GR	Roll Box 58/87MM Grey 450MM	Set	2,900.00	1 Set
2	RB500GR	Roll Box 58/87MM Grey 500MM	Set	2,900.00	1 Set
3	RB550GR	Roll Box 58/87MM Grey 550MM	Set	2,900.00	1 Set

d-lite lift

LIFT-UP SYSTEM



Slow, Easy and Quiet

Specially designed to make a positive contribution to the consumer's life, SAMET Lift Up Door Systems is innovative elegant and convenient, as well as powerful and durable.

In each cell you will feel the quality standards innovative structure and design power of Samet.

D-Lite Lift Hingeless Lift-Up Door Mechanism Package

d-lite lift



NO	CODE	DEFINITION/FEATURE	UNIT	MRP	PACKAGE CONTENT
1	DLITEC1MO	D Lite Hingeless Lift Up Power C1 H-600mm Mocha	Set	3,915.00	1 Set
2	DLITEC1WH	D Lite Hingeless Lift Up Power C1 H-600mm White	Set	3,915.00	1 Set
3	DLITEC1AN	D Lite Hingeless Lift Up Power C1 H-600mm Anthracite	Set	3,915.00	1 Set
4	DLITEC1GR	D Lite Hingeless Lift Up Power C1 H-600mm Grey	Set	3,915.00	1 Set

MultiLift Double Lift-Up Door Mechanism Package

MultiLift



NO	CODE	DEFINITION/FEATURE	UNIT	MRP	PACKAGE CONTENT
1	ML600C1GR	Multi Lift 600mm Power C1 Grey	Set	11,153.00	1 Set
2	ML600D1GR	Multi Lift 600mm Power D1 Grey	Set	12,025.00	1 Set
3	ML650C1GR	Multi Lift 650mm Power C1 Grey	Set	11,153.00	1 Set
4	ML650D1GR	Multi Lift 650mm Power D1 Grey	Set	12,025.00	1 Set
5	ML720D1GR	Multi Lift 720mm Power D1 Grey	Set	11,130.00	1 Set
6	ML720E1GR	Multi Lift 720mm Power E1 Grey	Set	12,023.00	1 Set
7	ML800D1GR	Multi Lift 800mm Power D1 Grey	Set	11,130.00	1 Set
8	ML800E1GR	Multi Lift 800mm Power E1 Grey	Set	12,023.00	1 Set
9	ML865D1GR	Multi Lift 865mm Power D1 Grey	Set	11,130.00	1 Set
10	ML865E1GR	Multi Lift 865mm Power E1 Grey	Set	12,023.00	1 Set

Gas Spring



NO	CODE	DEFINITION/FEATURE	UNIT	MRP	PACKAGE CONTENT
1	GP80N	Gas Piston Lift Up 80N	Set	482.00	20 Set
2	GP100N	Gas Piston Lift Up 100N	Set	499.00	20 Set
3	GP120N	Gas Piston Lift Up 120N	Set	521.00	20 Set



Dorset Industries Private Limited

CIN:U29300DL2017PTC326885

Corp. Office :

AIHP Horizon | 445 | Udyog Vihar Phase V | Sector - 19 | Gurugram | Haryana | 122008 | INDIA
Phones: + 91-124-4567890 | website : www.dorsetindia.com | e-mail: response@dorsetindia.com

Branch Offices :

Bengaluru | Hyderabad | Kolkata | Pune | Mumbai

**Copyright © 2021
ALL RIGHT RESERVED**

Reproduction or transmission in any form or by any means electronic or mechanical of this publication in part or whole is prohibited, including photocopy, recording or any other information storage and retrieval system, without prior permission from Dorset Industries Private Limited We reserve the right to make alteration to the model without prior notice. All sizes are finished as portrayed through photographs in this catalogue may vary from the actual product. Please check physical product before placing your order.

dorsëtcare  **Call at: 1800 11 4448**



Scan To Download the App

www.dorsetindia.com

Follow us on    