

Price List

w.e.f. July 2021

Version 5.1



FURNITURE FITTINGS



IPSA is one of the leading door hardware manufacturing companies in India. IPSA products are designed to meet the high end needs of consumers belonging to all income groups. Ease of use, design, high security and quality are the four major aspects that make IPSA a preferable brand.

Our Clients

| | | | | | |
|--|--|--|--|--|--|
| | | | | | |
| | | | | | |
| | | | | | |
| | | | | | |
| | | | | | |
| | | | | | |
| | | | | | |
| | | | | | |
| | | | | | |



IPSA

GETTING INNOVATION IN MARKET THROUGH DESIGN

IPSA's luxury range offers a unique blend of security with elegance. this range consists of prestigious and high level products satisfying the luxury needs and refined tastes of the consumers, giving their home/work place a magnificent look.

IPSA never compromise to quality and function, individuality and authenticity. Bonding heritage with creativity, curiosity and innovation; just like a family company, the company grows at every level.

OUR MISSION

To exceed our customers expectations in quality, delivery and cost through continuous improvement and innovation in business; and building good customer relations.

OUR VISION

We are:

1. one of the best companies in the international hardware industry.
2. a company with trustworthy, leading brands for the consumers.
3. a preferred supplier for all segments.
4. a strong and sound company for our stakeholders.
5. a forward ? looking company.
6. an extraordinary place to work in.

OUR PASSION

Our passion is to serve more and more people; with better and better products and services each day; and to grow and expand in various other sectors under the brand name IPSA.

WE ARE ENVIRONMENT FRIENDLY

Each design and production step is carefully checked with regards to the environmental and each of the following decision is taken if our eco-compatibility are fully reached. this means that when we manufacture our products, ipsa doorware will be assured by the advanced technologies and very strict controls carried out by a very highly qualified personnel, generating a product conceived constantly thinking of the environment.

WE ARE SOCIAL RESPONSIBLE

We are committed to improving the quality of life of the community we serve by following all the labour laws and using safe and secure technologies at work. we believe in paying back to society from whatever we earn and for this our management is continuously involved in social practices and donations, not only to gain our customers, employees and other stakeholders' trust in us, but also to fulfill our social responsibility.



IPSA Globally Presence

you can access our extensive and exclusive range of products through authorised dealers and service centers to get top-notch sales and service experience worldwide. our aim is to address your needs quickly and conveniently and for that we have trained and dedicated team. we have also recognized the different needs of the customers in different regions of our country and to cater to these needs we have established a well equipped dealer network in the major cities across the world.

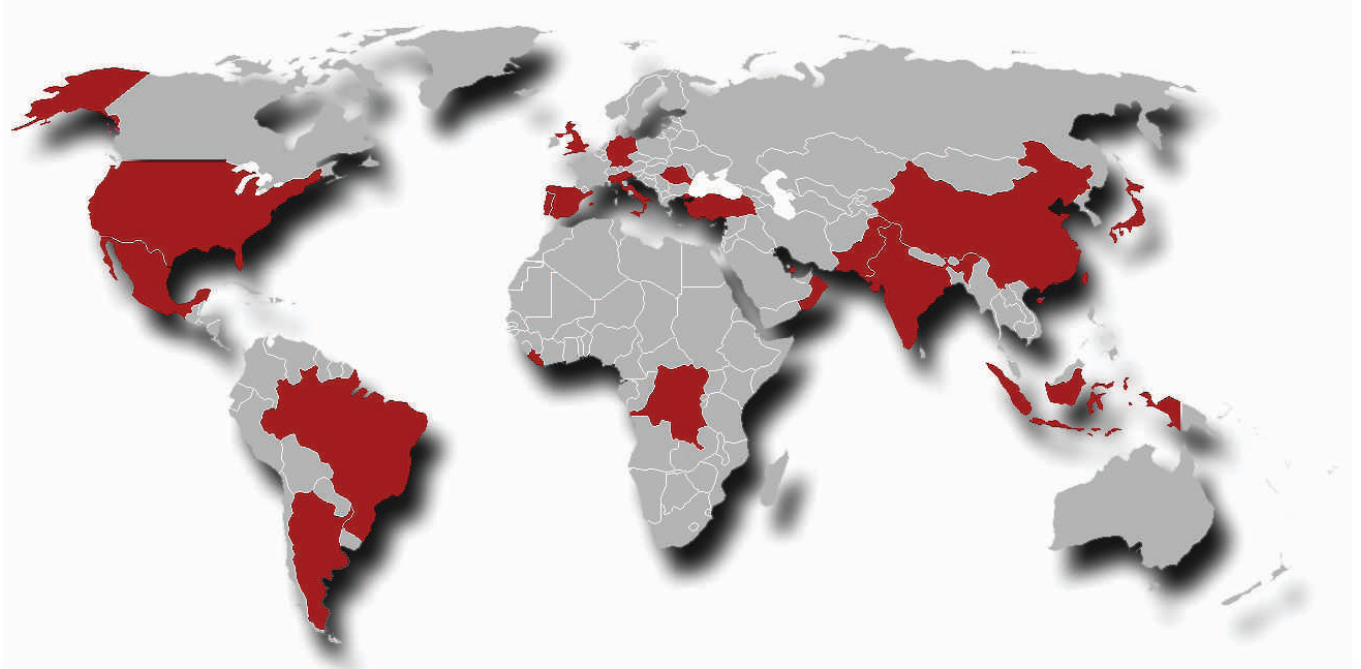

● New Delhi Corporate Office ● IP SA Global Presence





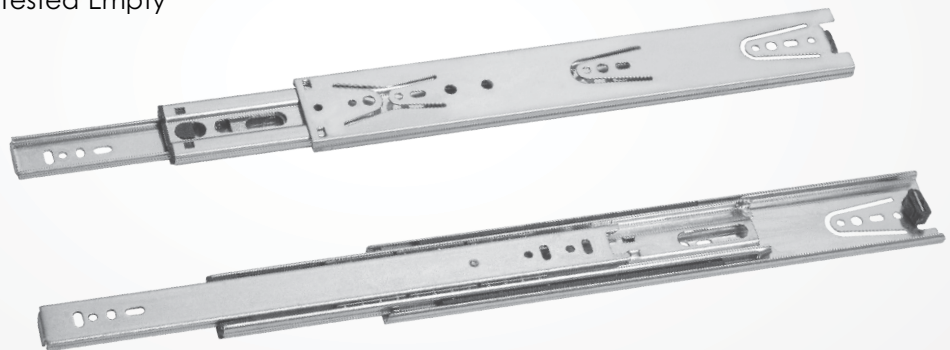



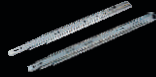

ANTI RUST – BALL BEARING SLIDER

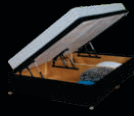
- 4 Ball Mechanism for Better Performance
- BIFMA / ANSI Approved
- European Anti-Rust Coating
- 96 Hrs. + Salt Spray Tested
- 45,000+ Cycles Tested Full Load 45kg
- 200,000+ Cycles Tested Empty

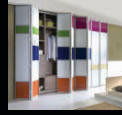

We are certified CE FC

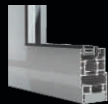

| | | |
|---|----------------------|-------|
|  | Auto Hinges | 7-14 |
|  | Drawer Sliders | 15-18 |
|  | Tandem Box | 19-21 |
|  | Gas Spring | 23 |
|  | Bed Fittings | 24 |
|  | Slider Roller Spring | 25-28 |
|  | Overlap Sliding | 29 |
|  | Inline Sliding | 30 |
|  | Sliding Folding | 31 |
|  | Bifold Uplift | 32-33 |
|  | Wardrobe Fittings | 34-37 |
|  | Kitchen Fittings | 38-40 |
|  | Aluminium Profile | 41-51 |



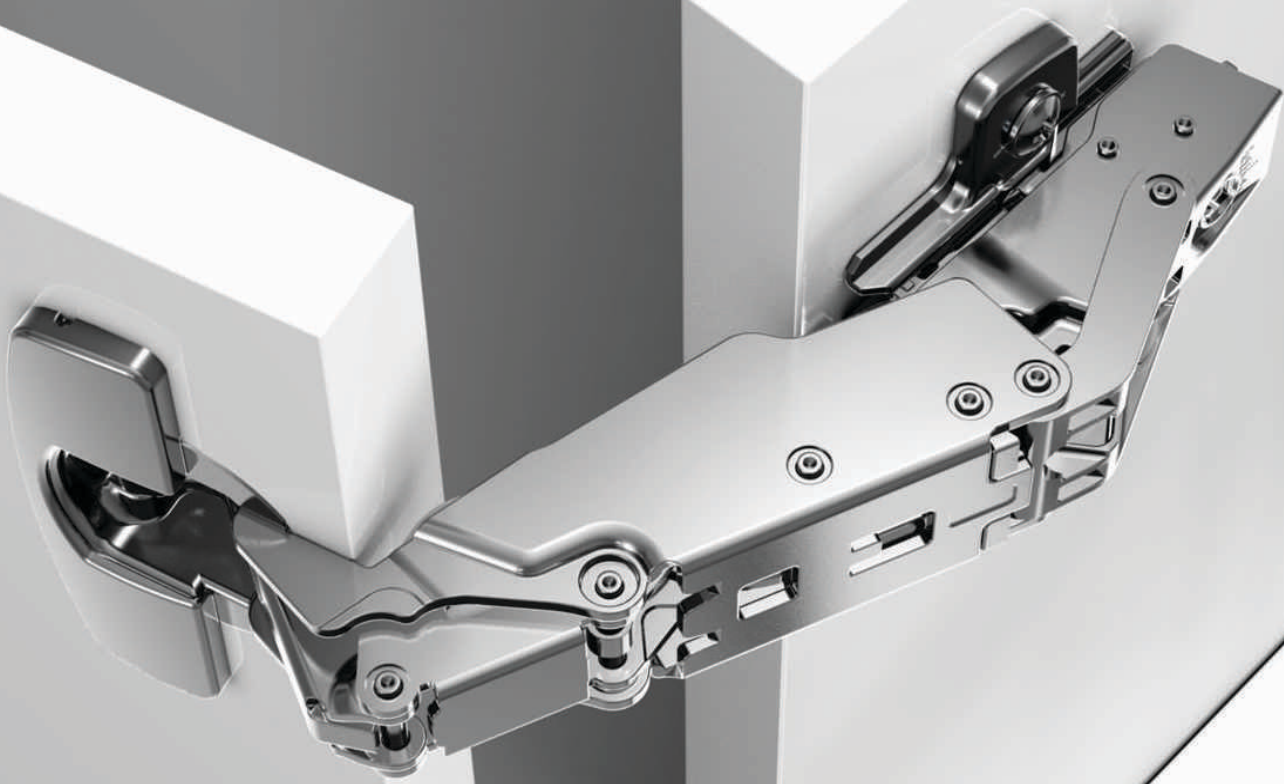

Cabinet Hinges

FURNITURE FITTINGS

Auto Hinge

Slide-on hinge

SlideOn

Technical information

Mounting options:

There are three basic mounting options.

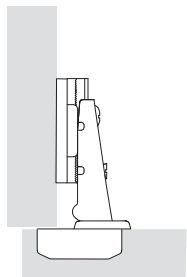

Full overlay:

This is where the door is positioned in front of the cabinet side panel, with only a small gap remaining at the side to provide the space necessary for the door to open reliably.

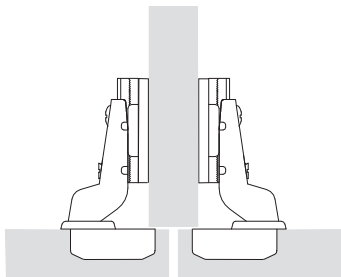

Half overlay:

This is where two doors are positioned in front of a cabinet centre panel, with the required overall reveal between them. In other words, each door has a reduced overlay. Cranked hinges are used.

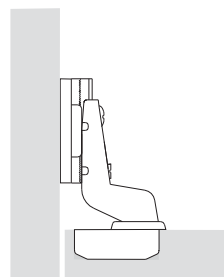

Inset:

This is where the door is positioned inside the cabinet, i.e. next to the cabinet side panel. Here too, a gap is needed so that the door can open reliably. Highly cranked hinges are used here.

Minimum door reveal:

The minimum reveal, also known as door clearance or minimum clearance, is the space required at the side for opening a door.

The amount of door clearance depends on cup distance C, door thickness and the type of hinge selected. Radii on the door edges reduce the minimum clearance.

The required minimum reveal is shown in the table for the respective hinge types.

For half-overlay applications, the total reveal selected between the doors must be at least twice the door clearance. Both doors can then be opened at the same time.

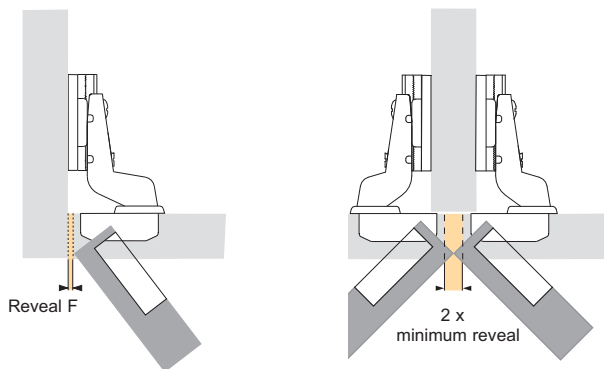

Cup distance C:

Cup distance C is the distance between door edge and the edge of the cup drilling. Resulting from the type of door movement, the maximum cup distance depends on the specific hinge type. The greater the distance selected for cup distance C, the smaller door clearance will be, i.e. the minimum reveal required.

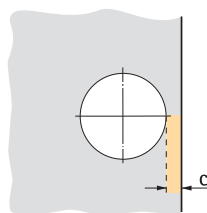

Door overlay:

Door overlay, or overlay A, is the distance by which the door extends beyond the cabinet side.

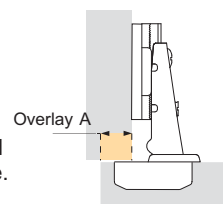

Reveal F:

The reveal is the distance from the outer edge of the door to the outer side of the cabinet in the case of full overlay applications, and the distance between two doors in the case of half-overlay applications. With the inset door, the reveal is the distance from the outer edge of the door to the inside of the cabinet side panel.

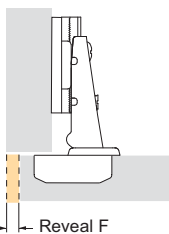

Number of hinges per door:

Door width, height and weight as well as the material quality of the door are decisive factors in determining the number of hinges required. The factors encountered in practice differ widely from case to case. For this reason, the number of hinges specified in the diagram must be understood as a guide only. If in doubt, it is recommended to carry out a trial door mounting.

For reasons of stability, the distance between the hinges must always be made as large as possible.

X = hinge spacing

(Guide values for 19 mm chipboard panels in a density of 130 kg/m

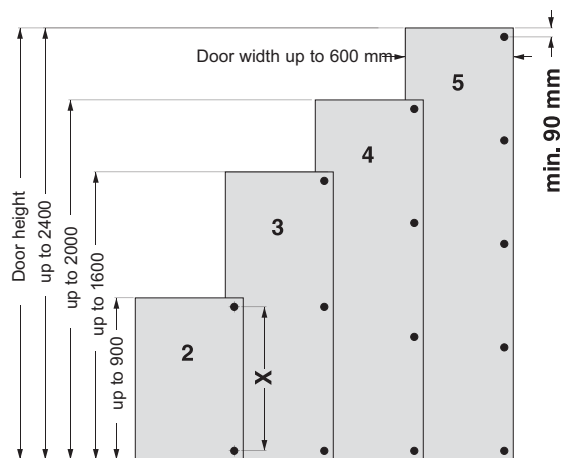

Introducing
Soft Close Hydraulic Hinge
(X Series)



Made in India

Cabinet Hinges

Soft Close Hydraulic Hinge (X Series)

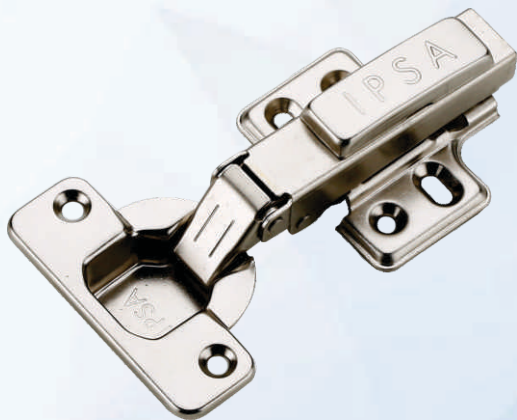

Product Code 6396

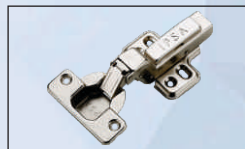

Product Code 4522



Product Code 9011

Soft Close Hydraulic Hinge 4 hole
Soft Close Hydraulic Hinges
for 19-21 mm Door Thickness

(Accessories)



Open degree: 105°
Height of hinge cup: 15 mm
Diameter of Hinge cup: 35 mm
Recommended door thickness:
19-21mm

| Product Code | Item Description | Size (in cranks) | Finish | UOM | Price (In Rs) | HSN Code | GST Tax Rate |
|--------------|-----------------------------------|------------------|--------|--------|---------------|----------|--------------|
| 6396 | Soft Close Hydraulic Hinge 4 Hole | 0 | SS | Per Pc | 111.00 | 83021090 | 18% |
| 4522 | Soft Close Hydraulic Hinge 4 Hole | 8 | SS | Per Pc | 116.00 | 83021090 | 18% |
| 9011 | Soft Close Hydraulic Hinge 4 Hole | 15 | SS | Per Pc | 121.00 | 83021090 | 18% |

Thick Door Hydraulic Hinge 32mm



Product Code 4450



Product Code 6805



Product Code 4329

Thick Door Hydraulic Hinge
Thick Door Hydraulic Hinge
for 19-32 mm Door Thickness

(Accessories)



Open degree: 95 degree
Height of hinge cup: 14
Diameter of Hinge cup: 22
Recommended door thickness:
19-32 mm

| Product Code | Item Description | Size (in cranks) | Finish | UOM | Price (In Rs) | HSN Code | GST Tax Rate |
|--------------|---------------------------------|------------------|--------|--------|---------------|----------|--------------|
| 4450 | Thick Door Hydraulic Hinge 32mm | 0 | SS | Per Pc | 198.00 | 83021090 | 18% |
| 6805 | Thick Door Hydraulic Hinge 32mm | 8 | SS | Per Pc | 203.00 | 83021090 | 18% |
| 4329 | Thick Door Hydraulic Hinge 32mm | 15 | SS | Per Pc | 209.00 | 83021090 | 18% |

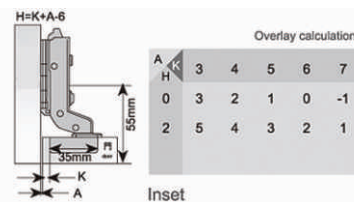
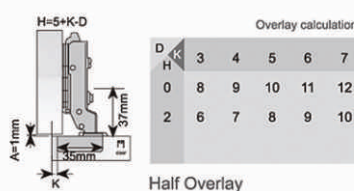
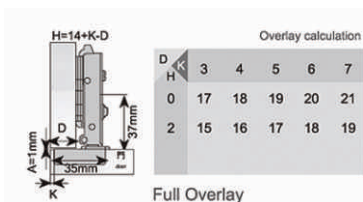

Cabinet Hinges

T Series Hinge

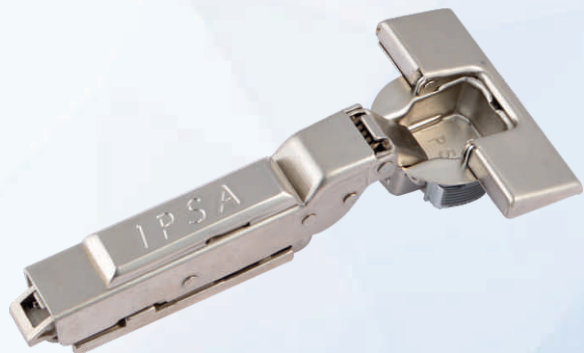

Product Code 13948



Product Code 13949



Product Code 13950

T- series Hinge
Slim Hydraulic Hinges
for 14-21 mm Door Thickness

(Accessories)



Open degree: 105° degree

Height of hinge cup: 18 mm

Diameter of Hinge cup: 35mm

Recommended door thickness:
14-21 mm

| Product Code | Item Description | Size (in cranks) | Finish | UOM | Price (In Rs) | HSN Code | GST Tax Rate |
|--------------|----------------------|------------------|--------|--------|---------------|----------|--------------|
| 13948 | Slim Hydraulic Hinge | 0 | SS | Per Pc | 299.00 | 83021090 | 18% |
| 13949 | Slim Hydraulic Hinge | 8 | SS | Per Pc | 299.00 | 83021090 | 18% |
| 13950 | Slim Hydraulic Hinge | 15 | SS | Per Pc | 299.00 | 83021090 | 18% |

Soft Close (3 D Series)

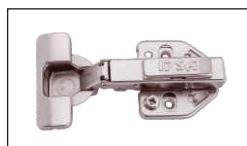
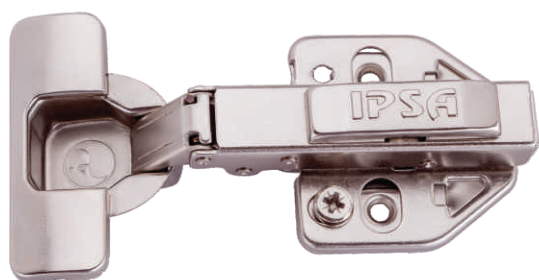

Product Code 6111

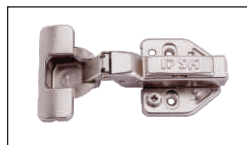

Product Code 7784



Product Code 3713

Soft Close Hinge (3 D Series)
Soft Close Hydraulic Hinges
for 19-24 mm Door Thickness

(Accessories)



Open degree: 120°

Height of hinge cup:

Diameter of Hinge cup: 35 mm

Recommended door thickness
19-24mm

| Product Code | Item Description | Size (in cranks) | Finish | UOM | Price (In Rs) | HSN Code | GST Tax Rate |
|--------------|---------------------|------------------|--------|--------|---------------|----------|--------------|
| 6111 | 3D Hydraulic Hinges | 0 | SS | Per Pc | 169.00 | 83021090 | 18% |
| 7784 | 3D Hydraulic Hinges | 8 | SS | Per Pc | 169.00 | 83021090 | 18% |
| 3713 | 3D Hydraulic Hinges | 15 | SS | Per Pc | 169.00 | 83021090 | 18% |

Cabinet Hinges

SS304 Hydraulic Hinge

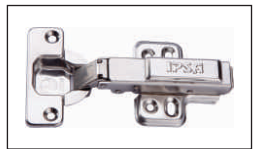

Product Code 8129



Product Code 7866

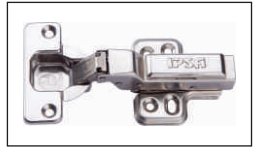

Product Code 8709

SS304 Hydraulic Hinge
Soft Close Hydraulic Hinges for 19-24 mm Door Thickness

(Accessories)

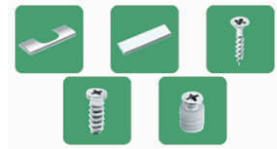

Open degree: 95 degree
Height of hinge cup: 15 mm
Diameter of Hinge cup: 35 mm
Recommended door thickness: 19-24 mm

| Product Code | Item Description | Size (in cranks) | Finish | UOM | Price (In Rs) | HSN Code | GST Tax Rate |
|--------------|-----------------------|------------------|--------|--------|---------------|----------|--------------|
| 8129 | SS304 Hydraulic Hinge | 0 | SS | Per Pc | 239.00 | 83021090 | 18% |
| 7866 | SS304 Hydraulic Hinge | 8 | SS | Per Pc | 244.00 | 83021090 | 18% |
| 8709 | SS304 Hydraulic Hinge | 15 | SS | Per Pc | 249.00 | 83021090 | 18% |

SS202 Hydraulic Hinge



Product Code 12194



Product Code 12195



Product Code 12196

SS202 Hydraulic Hinge
Soft Close Hydraulic Hinges for 19-24 mm Door Thickness

(Accessories)



Open degree: 95 degree
Height of hinge cup: 14 mm
Diameter of Hinge cup: 23 mm
Recommended door thickness: 19-24 mm

| Product Code | Item Description | Size (in cranks) | Finish | UOM | Price (In Rs) | HSN Code | GST Tax Rate |
|--------------|-----------------------|------------------|--------|--------|---------------|----------|--------------|
| 12194 | SS202 Hydraulic Hinge | 0 | SS | Per Pc | 189.00 | 83021090 | 18% |
| 12195 | SS202 Hydraulic Hinge | 8 | SS | Per Pc | 189.00 | 83021090 | 18% |
| 12196 | SS202 Hydraulic Hinge | 15 | SS | Per Pc | 189.00 | 83021090 | 18% |

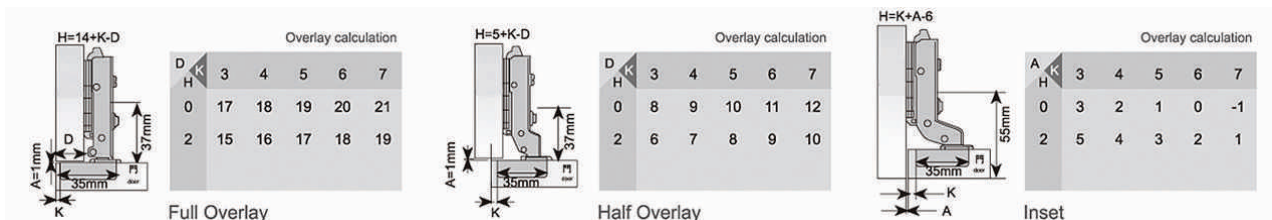

Auto Hinge

Clip on Auto Hinge (Non-Soft Close)



Product Code 8802



Product Code 7247



Product Code 1547

Clip On Auto Hinge
Non-Soft Close Hinge
for 19-24 mm Door Thickness

Open degree: 95 degree
Height of hinge cup:
Diameter of Hinge cup:
Recommended door thickness

| Product Code | Item Description | Size (in cranks) | Finish | UOM | Price (In Rs) | HSN Code | GST Tax Rate |
|--------------|--------------------|------------------|--------|--------|---------------|----------|--------------|
| 8802 | Clip on Auto Hinge | 0 | SS | Per Pc | 79.00 | 83021090 | 18% |
| 7247 | Clip on Auto Hinge | 8 | SS | Per Pc | 79.00 | 83021090 | 18% |
| 1547 | Clip on Auto Hinge | 15 | SS | Per Pc | 79.00 | 83021090 | 18% |

Auto Hinge Slide on (Non-Soft Close)

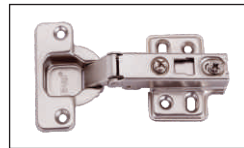
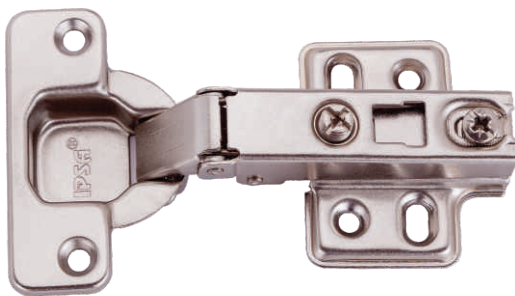

Product Code 4065

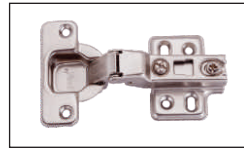

Product Code 7619

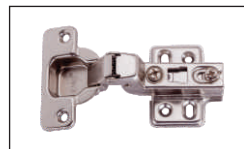

Product Code 7715

Auto Hinges Slide On
Non-Soft Close Hinges
for 19-24 mm Door Thickness

(Accessories)



Open degree: 95 degree
Height of hinge cup:
Diameter of Hinge cup:
Recommended door thickness

| Product Code | Item Description | Size (in cranks) | Finish | UOM | Price (In Rs) | HSN Code | GST Tax Rate |
|--------------|---------------------|------------------|--------|----------|---------------|----------|--------------|
| 4065 | Auto Hinge Slide on | 0 | SS | Per Pair | 89.00 | 83021090 | 18% |
| 7619 | Auto Hinge Slide on | 8 | SS | Per Pair | 89.00 | 83021090 | 18% |
| 7715 | Auto Hinge Slide on | 15 | SS | Per Pair | 89.00 | 83021090 | 18% |

Auto Hinge

165 Angle Hinge

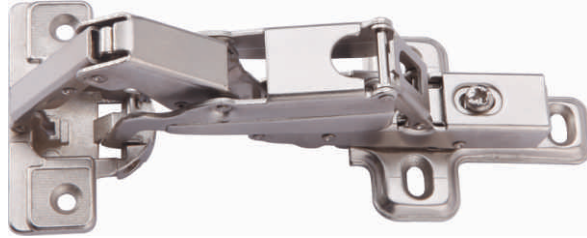

Pie Corner Soft - Close Hinge

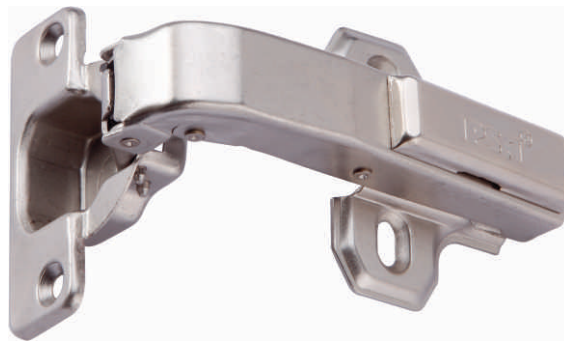

Angle- Soft Close

| Product Code | Item Description | Finish | UOM | Price (In Rs) | HSN Code | GST Tax Rate |
|--------------|-----------------------------------|--------|--------|---------------|----------|--------------|
| 8385 | 90° Pie Corner Soft - Close Hinge | SS | Per Pc | 249.00 | 83021090 | 18% |
| 4310 | 165° Wide Angle Soft-Close Hinge | SS | Per Pc | 449.00 | 83021090 | 18% |

Angle Slide On Hinge (Non Soft Close)

| Product Code | Item Description | Finish | UOM | Price (In Rs) | HSN Code | GST Tax Rate |
|--------------|---------------------------------|--------|--------|---------------|----------|--------------|
| 4232 | 165 Degree Angle Hinge Slide On | SS | Per Pc | 209.00 | 83021090 | 18% |
| 9020 | 90 Degree Angle Hinge Slide On | SS | Per Pc | 109.00 | 83021090 | 18% |
| 13951 | 45 Degree Angle Hinge Slide On | SS | Per Pc | 109.00 | 83021090 | 18% |
| 13952 | 135 Degree Angle Hinge Slide On | SS | Per Pc | 179.00 | 83021090 | 18% |

Auto Hinge

Glass Hydraulic Hinge



Product Code 7317



Product Code 4718



Product Code 5905

Glass Hydraulic Hinge
Hydraulic Hinges
for glass door cabinets

Hydraulic Hinge
Base can be removed
Opening angle: 95°
Diameter of Hinge cup: 35mm
Glass thickness: 4-8 mm

| Product Code | Item Description | Size (in cranks) | Finish | UOM | Price (In Rs) | HSN Code | GST Tax Rate |
|--------------|-----------------------|------------------|--------|--------|---------------|----------|--------------|
| 7317 | Glass Hydraulic Hinge | 0 | SS | Per Pc | 169.00 | 83021090 | 18% |
| 4718 | Glass Hydraulic Hinge | 8 | SS | Per Pc | 169.00 | 83021090 | 18% |
| 5905 | Glass Hydraulic Hinge | 15 | SS | Per Pc | 169.00 | 83021090 | 18% |

Profile Hydraulic Hinge

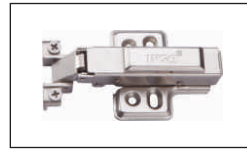

Product Code 5503

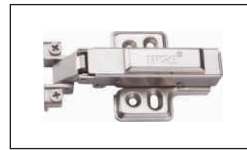

Product Code 8117

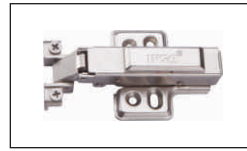

Product Code 4849

Profile Hydraulic Hinge
Concealed Profile
Hydraulic Hinges
for 19-24 mm Door Thickness
(Accessories)



Hydraulic Hinge
Base can be removed
Opening angle: 95°

| Product Code | Item Description | Size (in cranks) | Finish | UOM | Price (In Rs) | HSN Code | GST Tax Rate |
|--------------|-------------------------|------------------|--------|--------|---------------|----------|--------------|
| 5503 | Profile Hydraulic Hinge | 0 | SS | Per Pc | 269.00 | 83021090 | 18% |
| 8117 | Profile Hydraulic Hinge | 8 | SS | Per Pc | 269.00 | 83021090 | 18% |
| 4849 | Profile Hydraulic Hinge | 15 | SS | Per Pc | 269.00 | 83021090 | 18% |

Drawer Sliders

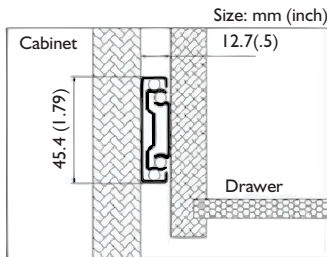

Use scope: desk drawer, cabinets, storage tank, general furniture etc.
 Features: drawer and cabinet wall can be installed separately, drawer open convenient automatic lock function can prevent the drawer slide
 Load: 100 lb (45 Kg)/group, 18 '(slide)
 Surface treatment: zinc, CED
 Material: high tension manufacture (1.2mm, 1.2mm and 1.4mm)
 Length: 10'-24 "(250 mm -600 mm)

Ball Bearing Drawer Slider

| Product Code | Item Description | Size (Inch) | Finish | UOM | Price (In Rs) | HSN Code | GST Tax Rate |
|--------------|----------------------|-------------|--------|----------|---------------|----------|--------------|
| 14160 | 250mm 1.2x1.2x1.4 mm | 10 | SS | Per Pair | 390.00 | 83024200 | 18% |
| 14161 | 300mm 1.2x1.2x1.4 mm | 12 | SS | Per Pair | 468.00 | 83024200 | 18% |
| 14162 | 350mm 1.2x1.2x1.4 mm | 14 | SS | Per Pair | 546.00 | 83024200 | 18% |
| 14163 | 400mm 1.2x1.2x1.4 mm | 16 | SS | Per Pair | 624.00 | 83024200 | 18% |
| 14164 | 450mm 1.2x1.2x1.4 mm | 18 | SS | Per Pair | 702.00 | 83024200 | 18% |
| 14165 | 500mm 1.2x1.2x1.4 mm | 20 | SS | Per Pair | 780.00 | 83024200 | 18% |
| 14166 | 550mm 1.2x1.2x1.4 mm | 22 | SS | Per Pair | 858.00 | 83024200 | 18% |
| 14167 | 600mm 1.2x1.2x1.4 mm | 24 | SS | Per Pair | 936.00 | 83024200 | 18% |

Ball Bearing Drawer Slider Black CED

| Product Code | Item Description | Size (Inch) | Finish | UOM | Price (In Rs) | HSN Code | GST Tax Rate |
|--------------|----------------------|-------------|-----------|----------|---------------|----------|--------------|
| 14168 | 250mm 1.2x1.2x1.4 mm | 10 | Black CED | Per Pair | 390.00 | 83024200 | 18% |
| 14169 | 300mm 1.2x1.2x1.4 mm | 12 | Black CED | Per Pair | 468.00 | 83024200 | 18% |
| 14170 | 350mm 1.2x1.2x1.4 mm | 14 | Black CED | Per Pair | 546.00 | 83024200 | 18% |
| 14171 | 400mm 1.2x1.2x1.4 mm | 16 | Black CED | Per Pair | 624.00 | 83024200 | 18% |
| 14172 | 450mm 1.2x1.2x1.4 mm | 18 | Black CED | Per Pair | 702.00 | 83024200 | 18% |
| 14173 | 500mm 1.2x1.2x1.4 mm | 20 | Black CED | Per Pair | 780.00 | 83024200 | 18% |
| 14174 | 550mm 1.2x1.2x1.4 mm | 22 | Black CED | Per Pair | 858.00 | 83024200 | 18% |
| 14175 | 600mm 1.2x1.2x1.4 mm | 24 | Black CED | Per Pair | 936.00 | 83024200 | 18% |

Drawer Sliders

ANTI RUST - BALL BEARING SLIDER

- 4 Ball Mechanism for Better Performance
- BIFMA / ANSI Approved
- European Anti-Rust Coating
- 96 Hrs. + Salt Spray Tested (SS Finish)
- 1000+ Hrs. Salt Spray Tested (CED Finish)
- 45,000+ Cycles Tested Full Load 45kg
- 200,000+ Cycles Tested Empty

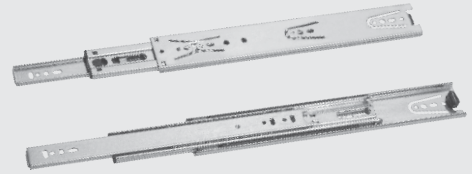

45 Kg Ball Bearing Drawer Slider

| Product Code | Item Description | Size (Inch) | Finish | UOM | Price (In Rs) | HSN Code | GST |
|--------------|--------------------|-------------|--------|----------|---------------|----------|-----|
| 6324 | 1.2 x 1.2 x 1.5 mm | 10 | SS | Per Pair | 280.00 | 83024200 | 18% |
| 5511 | 1.2 x 1.2 x 1.5 mm | 12 | SS | Per Pair | 336.00 | 83024200 | 18% |
| 4766 | 1.2 x 1.2 x 1.5 mm | 14 | SS | Per Pair | 392.00 | 83024200 | 18% |
| 4746 | 1.2 x 1.2 x 1.5 mm | 16 | SS | Per Pair | 448.00 | 83024200 | 18% |
| 5972 | 1.2 x 1.2 x 1.5 mm | 18 | SS | Per Pair | 504.00 | 83024200 | 18% |
| 5439 | 1.2 x 1.2 x 1.5 mm | 20 | SS | Per Pair | 560.00 | 83024200 | 18% |
| 6429 | 1.2 x 1.2 x 1.5 mm | 22 | SS | Per Pair | 616.00 | 83024200 | 18% |
| 5075 | 1.2 x 1.2 x 1.5 mm | 24 | SS | Per Pair | 672.00 | 83024200 | 18% |
| 8723 | 1.2 x 1.2 x 1.5 mm | 30 | SS | Per Pair | 960.00 | 83024200 | 18% |
| 3940 | 1.2 x 1.2 x 1.5 mm | 36 | SS | Per Pair | 1152.00 | 83024200 | 18% |

45 Kg Ball Bearing Drawer Slider

| Product Code | Item Description | Size (Inch) | Finish | UOM | Price (In Rs) | HSN Code | GST |
|--------------|--------------------|-------------|-----------|----------|---------------|----------|-----|
| 8582 | 1.2 x 1.2 x 1.5 mm | 10 | Black CED | Per Pair | 280.00 | 83024200 | 18% |
| 7191 | 1.2 x 1.2 x 1.5 mm | 12 | Black CED | Per Pair | 336.00 | 83024200 | 18% |
| 3745 | 1.2 x 1.2 x 1.5 mm | 14 | Black CED | Per Pair | 392.00 | 83024200 | 18% |
| 8636 | 1.2 x 1.2 x 1.5 mm | 16 | Black CED | Per Pair | 448.00 | 83024200 | 18% |
| 2573 | 1.2 x 1.2 x 1.5 mm | 18 | Black CED | Per Pair | 504.00 | 83024200 | 18% |
| 4589 | 1.2 x 1.2 x 1.5 mm | 20 | Black CED | Per Pair | 560.00 | 83024200 | 18% |
| 4514 | 1.2 x 1.2 x 1.5 mm | 22 | Black CED | Per Pair | 616.00 | 83024200 | 18% |
| 7915 | 1.2 x 1.2 x 1.5 mm | 24 | Black CED | Per Pair | 672.00 | 83024200 | 18% |
| 8629 | 1.2 x 1.2 x 1.5 mm | 30 | Black CED | Per Pair | 960.00 | 83024200 | 18% |
| 8637 | 1.2 x 1.2 x 1.5 mm | 36 | Black CED | Per Pair | 1152.00 | 83024200 | 18% |

Stainless Steel Ball Bearing Drawer Slider

| Product Code | Item Description | Size (Inch) | Finish | UOM | Price (In Rs) | HSN Code | GST |
|--------------|-------------------------------|-------------|--------|----------|---------------|----------|-----|
| 12780 | SS Ball Bearing Drawer Slider | 10 | SS | Per Pair | 440.00 | 83024200 | 18% |
| 12781 | SS Ball Bearing Drawer Slider | 12 | SS | Per Pair | 528.00 | 83024200 | 18% |
| 12782 | SS Ball Bearing Drawer Slider | 14 | SS | Per Pair | 616.00 | 83024200 | 18% |
| 12783 | SS Ball Bearing Drawer Slider | 16 | SS | Per Pair | 704.00 | 83024200 | 18% |
| 12784 | SS Ball Bearing Drawer Slider | 18 | SS | Per Pair | 792.00 | 83024200 | 18% |
| 12785 | SS Ball Bearing Drawer Slider | 20 | SS | Per Pair | 880.00 | 83024200 | 18% |
| 12786 | SS Ball Bearing Drawer Slider | 22 | SS | Per Pair | 968.00 | 83024200 | 18% |
| 12787 | SS Ball Bearing Drawer Slider | 24 | SS | Per Pair | 1056.00 | 83024200 | 18% |

Drawer Sliders

Soft close drawer slider



45 kg Soft Close Ball Bearing Drawer Slider

| | Item Description | Size (Inch) | Finish | UOM | Price (In Rs) | HSN Code | GST Tax Rate |
|------|--|-------------|--------|----------|---------------|----------|--------------|
| 3774 | Ball Bearing Slider 1.2 x 1.2 x 1.4 mm | 12 | SS | Per Pair | 649.00 | 83024200 | 18% |
| 3954 | Ball Bearing Slider 1.2 x 1.2 x 1.4 mm | 14 | SS | Per Pair | 719.00 | 83024200 | 18% |
| 8419 | Ball Bearing Slider 1.2 x 1.2 x 1.4 mm | 16 | SS | Per Pair | 779.00 | 83024200 | 18% |
| 4898 | Ball Bearing Slider 1.2 x 1.2 x 1.4 mm | 18 | SS | Per Pair | 839.00 | 83024200 | 18% |
| 8662 | Ball Bearing Slider 1.2 x 1.2 x 1.4 mm | 20 | SS | Per Pair | 899.00 | 83024200 | 18% |
| 5252 | Ball Bearing Slider 1.2 x 1.2 x 1.4 mm | 22 | SS | Per Pair | 979.00 | 83024200 | 18% |
| 6698 | Ball Bearing Slider 1.2 x 1.2 x 1.4 mm | 24 | SS | Per Pair | 1049.00 | 83024200 | 18% |



Heavy Duty Slider 100 Kg Capacity



| Heavy Duty 53mm Slider | | | | | | | |
|------------------------|---------------------------------------|----|----|----------|---------|----------|-----|
| 16913 | 100 Kg Ball Bearing Slider 53mm Width | 18 | SS | Per Pair | 1489.00 | 83024200 | 18% |
| 16912 | 100 Kg Ball Bearing Slider 53mm Width | 20 | SS | Per Pair | 1639.00 | 83024200 | 18% |
| 16911 | 100 Kg Ball Bearing Slider 53mm Width | 24 | SS | Per Pair | 1979.00 | 83024200 | 18% |
| 13953 | 100 Kg Ball Bearing Slider 53mm Width | 30 | SS | Per Pair | 2479.00 | 83024200 | 18% |
| 13954 | 100 Kg Ball Bearing Slider 53mm Width | 36 | SS | Per Pair | 2979.00 | 83024200 | 18% |

Drawer Sliders

Undermount Drawer Slider



| Product Code | Item Description | Size (Inch) | Finish | UOM | Price (In Rs) | HSN Code | GST Tax Rate |
|-----------------------------------|----------------------------|-------------|--------|----------|---------------|----------|--------------|
| Full Extension Under Mount | | | | | | | |
| 8327 | Full Extension Under Mount | 12 | SS | Per Pair | 1469.00 | 83024200 | 18% |
| 5814 | Full Extension Under Mount | 14 | SS | Per Pair | 1519.00 | 83024200 | 18% |
| 4234 | Full Extension Under Mount | 16 | SS | Per Pair | 1669.00 | 83024200 | 18% |
| 6765 | Full Extension Under Mount | 18 | SS | Per Pair | 1899.00 | 83024200 | 18% |
| 8707 | Full Extension Under Mount | 20 | SS | Per Pair | 1899.00 | 83024200 | 18% |
| 5456 | Full Extension Under Mount | 22 | SS | Per Pair | 2149.00 | 83024200 | 18% |

| | | | | | | | |
|------------------------------|-----------------------------|----|----|----------|---------|----------|-----|
| Push Pull Under Mount | | | | | | | |
| 6338 | Push Pull Under Mount 35 Kg | 12 | SS | Per Pair | 1469.00 | 83024200 | 18% |
| 8267 | Push Pull Under Mount 35 Kg | 14 | SS | Per Pair | 1519.00 | 83024200 | 18% |
| 7822 | Push Pull Under Mount 35 Kg | 16 | SS | Per Pair | 1669.00 | 83024200 | 18% |
| 6776 | Push Pull Under Mount 35 Kg | 18 | SS | Per Pair | 1899.00 | 83024200 | 18% |
| 4096 | Push Pull Under Mount 35 Kg | 20 | SS | Per Pair | 1899.00 | 83024200 | 18% |
| 4810 | Push Pull Under Mount 35 Kg | 22 | SS | Per Pair | 2149.00 | 83024200 | 18% |

| | | | | | | | |
|-------------------------------------|------------------------------------|----|----|----------|---------|----------|-----|
| Single Extension Under Mount | | | | | | | |
| 5088 | Single Extension Under Mount 35 Kg | 12 | SS | Per Pair | 709.00 | 83024200 | 18% |
| 4441 | Single Extension Under Mount 35 Kg | 14 | SS | Per Pair | 859.00 | 83024200 | 18% |
| 7349 | Single Extension Under Mount 35 Kg | 16 | SS | Per Pair | 949.00 | 83024200 | 18% |
| 4614 | Single Extension Under Mount 35 Kg | 18 | SS | Per Pair | 1079.00 | 83024200 | 18% |
| 7520 | Single Extension Under Mount 35 Kg | 20 | SS | Per Pair | 1199.00 | 83024200 | 18% |
| 5813 | Single Extension Under Mount 35 Kg | 22 | SS | Per Pair | 1339.00 | 83024200 | 18% |

Tandem Box



With Square Bar

PREMIUM FURNITURE & KITCHEN FITTINGS

| Product | Product Code | Item Description | Size (Inch) | Finish | UOM | Price (In Rs) | HSN Code | GST Tax Rate |
|---------|--------------|------------------|-------------|--------|-----|---------------|----------|--------------|
|---------|--------------|------------------|-------------|--------|-----|---------------|----------|--------------|

Tandem Box B Series (With Square Bar)

| Product | | Item Description | | Size (Inch) | | Finish | | UOM | | Without Bar | |
|---|--|---------------------------|--|-------------|-----------|---------|---------|----------|-----|---------------|----------|
| | | | | | | | | | | Price (In Rs) | HSN Code |
|  | | Tandem Box square gallery | | 18 | Iron Gray | Per Set | 2849.00 | 83024200 | 18% | | |
| | | Tandem Box square gallery | | 20 | Iron Gray | Per Set | 2949.00 | 83024200 | 18% | | |
| | | Tandem Box square gallery | | 20 | White | Per Set | 2949.00 | 83024200 | 18% | | |
|  | | Tandem Box square gallery | | 18 | Iron Gray | Per Set | 3099.00 | 83024200 | 18% | | |
| | | Tandem Box square gallery | | 20 | Iron Gray | Per Set | 3199.00 | 83024200 | 18% | | |
| | | Tandem Box square gallery | | 20 | White | Per Set | 3199.00 | 83024200 | 18% | | |
|  | | Tandem Box square gallery | | 20 | Iron Gray | Per Set | 3449.00 | 83024200 | 18% | | |
| | | Tandem Box square gallery | | 20 | White | Per Set | 3449.00 | 83024200 | 18% | | |

Tandem Box





SLIM BOX

PREMIUM FURNITURE & KITCHEN FITTINGS

| Product | Product Code | Item Description | Size (Inch) | Finish | UOM | Price (In Rs) | HSN Code | GST Tax Rate |
|---------|--------------|------------------|-------------|--------|-----|---------------|----------|--------------|
|---------|--------------|------------------|-------------|--------|-----|---------------|----------|--------------|

C Series Tandem Box (Slim Box)

| | | 84 mm Lower | | | | | | |
|--|-------|---|-------|-----------------|---------|-----------|----------|---------|
| | |  | 13963 | Tandem slim box | 18 | Iron Gray | Per Set | 3299.00 |
| | 13964 | Tandem slim box | 20 | Iron Gray | Per Set | 3399.00 | 83024200 | 18% |
| | | 116 mm Middle | | | | | | |
| | |  | 13966 | Tandem slim box | 18 | Iron Gray | Per Set | 3499.00 |
| | 13967 | Tandem slim box | 20 | Iron Gray | Per Set | 3599.00 | 83024200 | 18% |
| | | 167 mm High | | | | | | |
| | |  | 13969 | Tandem slim box | 18 | Iron Gray | Per Set | 3979.00 |
| | 13970 | Tandem slim box | 20 | Iron Gray | Per Set | 4079.00 | 83024200 | 18% |

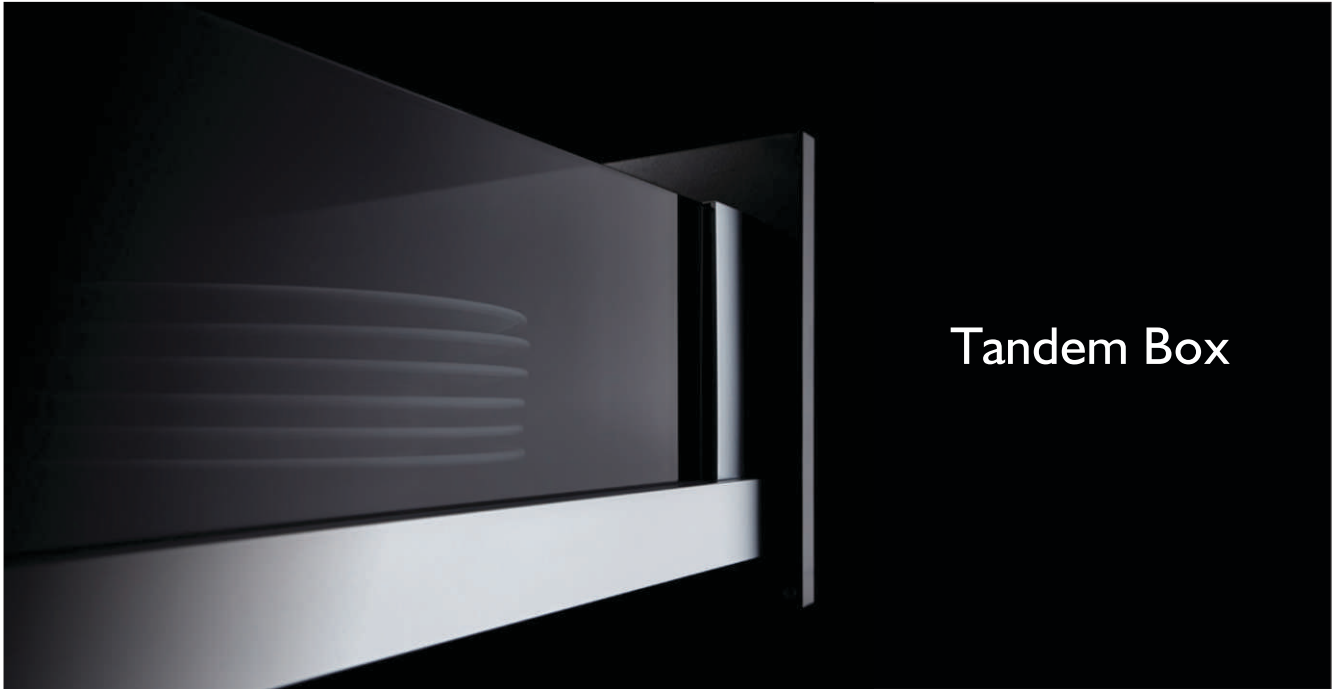

Tandem Box

| Product | Product Code | Item Description | Size (Inch) | Finish | UOM | Price (In Rs) | HSN Code | GST Tax Rate |
|---------|--------------|------------------|-------------|--------|-----|---------------|----------|--------------|
|---------|--------------|------------------|-------------|--------|-----|---------------|----------|--------------|



Tandem Box

D Series (With Glass Gallery)

| | | Lower | | | | | | |
|--|-------|---|-------|--------------------------|---------|-----------|----------|---------|
| | |  | 13972 | Tandem box glass gallery | 18 | Iron Gray | Per Set | 4429.00 |
| | 13973 | Tandem box glass gallery | 20 | Iron Gray | Per Set | 4539.00 | 83024200 | 18% |
| | | Middle | | | | | | |
| | |  | 13974 | Tandem box glass gallery | 18 | Iron Gray | Per Set | 5559.00 |
| | 13975 | Tandem box glass gallery | 20 | Iron Gray | Per Set | 5679.00 | 83024200 | 18% |
| | | High | | | | | | |
| | |  | 13976 | Tandem box glass gallery | 18 | Iron Gray | Per Set | 6699.00 |
| | 13977 | Tandem box glass gallery | 20 | Iron Gray | Per Set | 6799.00 | 83024200 | 18% |

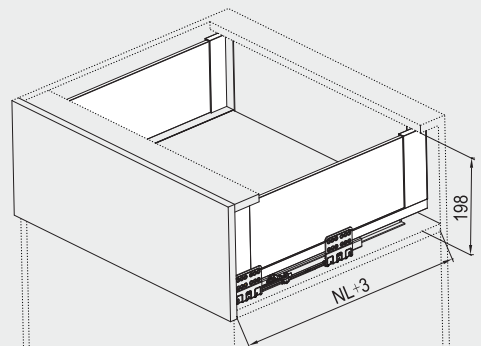

Tandem Box

| Product | Product Code | Item Description | Finish | UOM | Price (In Rs) | HSN Code | GST Tax Rate |
|---|--------------|--|-----------|---------|---------------|----------|--------------|
| B Series Inner Drawer Accessories (Only Front) | | | | | | | |
|  | 14241 | B series Inner drawer front connector | Iron Gray | Per Set | 579.00 | 83024200 | 18% |
| | 14242 | B series Inner Drawer 1200MM Pumping panel | Iron Gray | Per Pc | 3109.00 | 83024200 | 18% |
| C Series Inner Drawer Rod System (Only Front) | | | | | | | |
|  | 14244 | C Series 84mm Low Inner drawer front connector L/R | Iron Gray | Per Set | 919.00 | 83024200 | 18% |
|  | 14243 | C Series 167mm High Inner drawer front connector L/R | Iron Gray | Per Set | 1149.00 | 83024200 | 18% |
| | 14246 | C Series Inner Drawer 1200MM Pumping panel for Front square rod | Iron Gray | Per Set | 3109.00 | 83024200 | 18% |
| | 14247 | C Series Inner Drawer 1200MM Front square rod | Iron Gray | Per Set | 1609.00 | 83024200 | 18% |
|  | 14245 | C Series 199mm High Inner drawer front connector | Iron Gray | Per Set | 1379.00 | 83024200 | 18% |
| | 14246 | C Series Inner Drawer 1200MM Pumping panel for Front square rod | Iron Gray | Per Pc | 3109.00 | 83024200 | 18% |
| | 14247 | C Series Inner Drawer 1200MM Front square rod | Iron Gray | Per Set | 1609.00 | 83024200 | 18% |
| C Series Inner Drawer Glass System (Only Front Without Glass) | | | | | | | |
|  | 14248 | C Series 167mm Middle Inner drawer front connector L/R for Glass | Iron Gray | Per Set | 1149.00 | 83024200 | 18% |
| | 14250 | C Series 1200MM Pumping panel for Glass | Iron Gray | Per Pc | 2529.00 | 83024200 | 18% |
|  | 14249 | C Series 199 High Inner drawer front connector L/R for Glass | Iron Gray | Per Set | 1379.00 | 83024200 | 18% |
| | 14250 | C Series 1200MM Pumping panel for Glass | Iron Gray | Per Pc | 2529.00 | 83024200 | 18% |

Gas Spring



| Product Type | 80° | | | | 90° | | | | 110° | | | |
|--------------|------|------|------|------|------|------|------|------|------|------|------|------|
| | 300 | 400 | 500 | 600 | 300 | 400 | 500 | 600 | 300 | 400 | 500 | 600 |
| 80N | <2.6 | <2.2 | <1.7 | <1.3 | <2.4 | <2.0 | <1.6 | <1.2 | <2.1 | <1.7 | <1.4 | <1.0 |
| 100N | <3.3 | <2.7 | <2.2 | <1.6 | <3 | <2.5 | <2.0 | <1.5 | <2.6 | <2.2 | <1.7 | <1.3 |
| 120N | <4 | <3.3 | <2.6 | <2 | <3.6 | <3.0 | <2.4 | <1.8 | <3.2 | <2.6 | <2.1 | <1.6 |

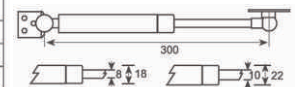

Note: Please select the appropriate type and the weigh of the door according to the table,so that achieve the best performance.

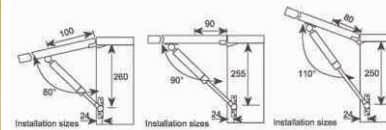

Material: Iron+Plastic damping or Copper + Plastic damping
 Finish: Silver grey
 Available for: Up-turning wooden door and aluminum-frame door
 Function: Supporting cabinet doors
 Features: The length of Pneumatic Stay—6" 8" 10" 12" 14" 16" 18" 20" 24" 30"
 The dimensions of pipe: 18x1.2/22x1.5mm;The dia.of rod: 8/10mm
 International advanced spray-paint technology
 Weight-lifting is 200N-1500N
 High density zinc alloy cast part
 Different pneumatic can be ordered for different weight of door panel

Optional accessories:



| Product | Product Code | Item Description | Size/weight | Finish | UOM | Price (In Rs) | HSN Code | GST Tax Rate |
|------------------------------|--------------|-----------------------|-------------|--------|--------|---------------|----------|--------------|
| Soft Close Gas Spring | | | | | | | | |
| Soft close Gas Spring | 14360 | Soft close Gas Spring | 10-15 Kg | white | Per Pc | 249.00 | 83024200 | 18% |
| Gas Spring 250x15*6mm | | | | | | | | |
| Gas Spring | 13330 | 50N | 5Kg | White | Per Pc | 169.00 | 83024200 | 18% |
| | 13331 | 100N | 10Kg | White | Per Pc | 169.00 | 83024200 | 18% |
| | 13332 | 150N | 15Kg | White | Per Pc | 169.00 | 83024200 | 18% |
| | 13333 | 200N | 20Kg | White | Per Pc | 189.00 | 83024200 | 18% |
| | 13334 | 250N | 25Kg | White | Per Pc | 219.00 | 83024200 | 18% |

Bed Fittings

Super Heavy Duty Bed Lift Mechanism



Finish: Painting/Powder
 Materials: iron
 Optional dimension: 900-1500 MM
 A:5MM Thickness | 3mm Thickness



| Product Code | Item Description | Size | UOM | Price (In Rs) | HSN Code | GST Tax Rate |
|--------------|------------------|------|-----|---------------|----------|--------------|
|--------------|------------------|------|-----|---------------|----------|--------------|

Bed fitting mechanism **with** Gas Spring (90Kg)

| | | | | | | |
|-------|----------------------------|---------------|---------|---------|----------|-----|
| 15449 | Bed fitting lift mechanism | length 1500mm | Per Set | 3599.00 | 83024200 | 18% |
| 15450 | Bed fitting lift mechanism | length 1200mm | Per Set | 3599.00 | 83024200 | 18% |

5 mm Heavy bed fitting mechanism **without** Gas Spring

| Code | Item Description | Size | UOM | Price (In Rs) | HSN Code | GST |
|-------|----------------------------|---------------|---------|---------------|----------|-----|
| 14232 | Bed fitting lift mechanism | length 1500mm | Per Set | 3299.00 | 83024200 | 18% |
| 14233 | Bed fitting lift mechanism | length 1200mm | Per Set | 3249.00 | 83024200 | 18% |
| 14234 | Bed fitting lift mechanism | length 900mm | Per Set | 3199.00 | 83024200 | 18% |

16" Gas Spring Only

| Code | Item Description | Size | UOM | Price (In Rs) | HSN Code | GST |
|-------|------------------|--------|----------|---------------|----------|-----|
| 14235 | Gas Spring 750N | 75 Kg | Per 2 Pc | 969.00 | 83024200 | 18% |
| 14236 | Gas Spring 1000N | 100 Kg | Per 2 Pc | 969.00 | 83024200 | 18% |
| 14237 | Gas Spring 1250N | 125 Kg | Per 2 Pc | 969.00 | 83024200 | 18% |
| 14238 | Gas Spring 1500N | 150 Kg | Per 2 Pc | 969.00 | 83024200 | 18% |
| 14239 | Gas Spring 2000N | 200 Kg | Per 2 Pc | 1999.00 | 83024200 | 18% |
| 14240 | Gas Spring 2500N | 250 Kg | Per 2 Pc | 1999.00 | 83024200 | 18% |

Bed Joint

| Code | Item | UOM | Price (In Rs) | HSN Code | GST |
|-------|------|---------|---------------|----------|-----|
| 14201 | | Per Set | 209.00 | 83024200 | 18% |



Slider Roller Spring

LUXURY DOOR ARCHITECTURAL HARDWARE



Sliding Roller

| Item Code | Product | Product Code | Item Description | UOM | Price (In Rs) | HSN Code | GST Tax Rate |
|----------------|---|--------------|---|--------------------|---------------|----------|--------------|
| Sliding Roller | | | | | | | |
| SL02 |  | 1056 | Roller For wooden Door 100kgs | Per Set | 1529.00 | 83024200 | 18% |
| SL03 |  | 10923 | Roller For wooden / Aluminium Door 80 Kgs | Per Set | 1469.00 | 83024200 | 18% |
| SL04 |  | 1126 | Roller For wooden Door 100 kgs | Per Set | 2069.00 | 83024200 | 18% |
| Track for SL04 |  12 Feet | 11267 | U Channel Track | Per 3 Mt Length | 2899.00 | 7604 | 18% |
| SL56 |  | 10665 | Roller For wooden Door 2 Door Set; 40 Kg | Per Set | 399.00 | 83024200 | 18% |
| SL 57 |  | 10986 | Furniture Sliding Roller For wooden Door : One Door Set 50 Kg | Per Set | 249.00 | 83024200 | 18% |
| Track for SL57 |  8 feet | 10607 | Double Upper Track for IP57 | Per Set | 1149.00 | 7604 | 18% |
| Track for SL57 |  8 feet | 1113 | Double Bottom Track for IP57 | Per Set | 1149.00 | 7604 | 18% |

Roller Fitting

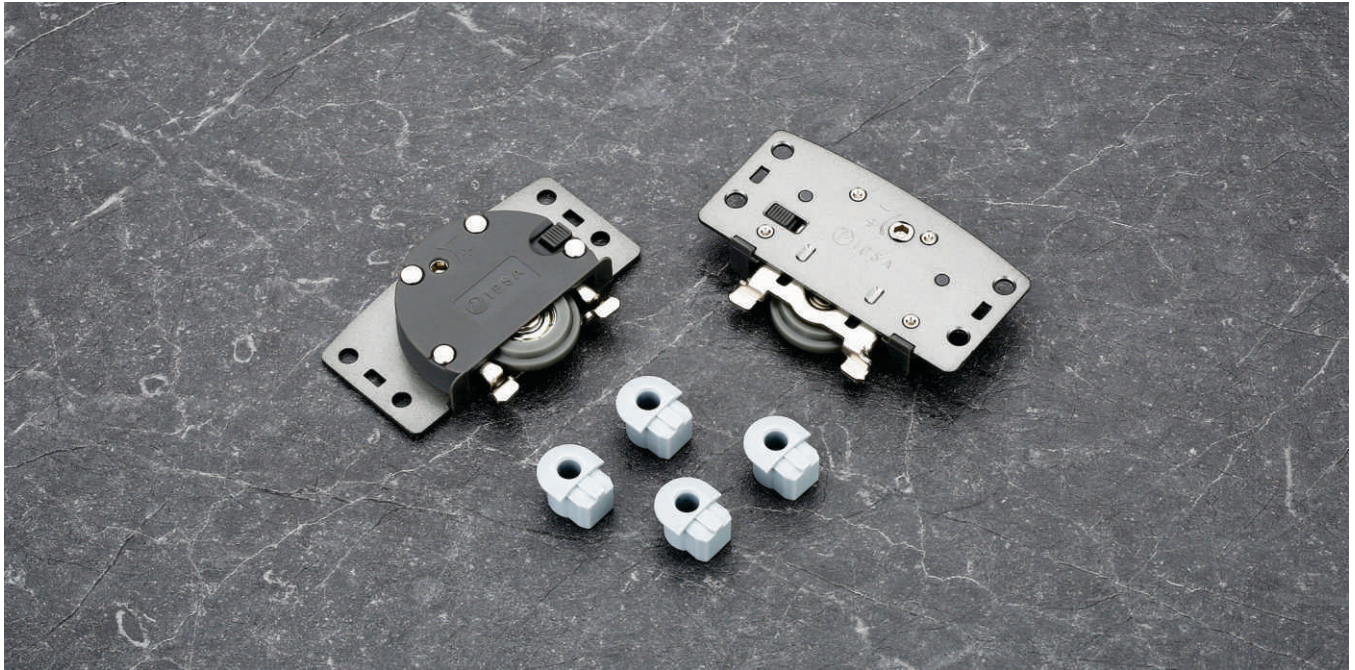

Universal Sliding Roller

Which widely using for wooden door, frame door, such one system can be work with 3 type aluminum rails

Features

- Roller can be both concealed and external assemble
- Roller easily grooving with 60mm cup diameter
- Door minimum width at 380mm (normally in market is 500mm)
- Door frame minimum width at 42mm (normally in market is 50mm)
- Door minimum gap at 6mm (normally in market is 9mm)
- Loading capacity 50kg each door
- 50000 times cycle test with SGS certification

Assemble

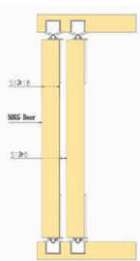

Concealed Version
Thickness of door: 16-32mm

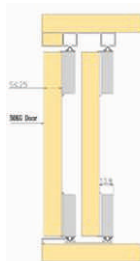

Overlap Version
Thickness of door: 16-20mm

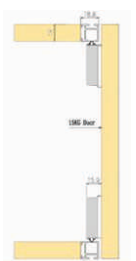



Door Flush Version
Thickness of door: 16-32mm

Application

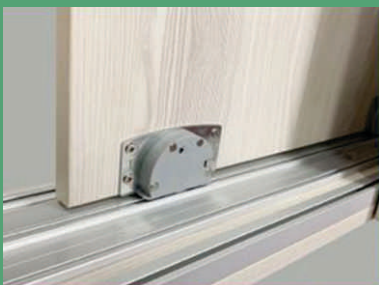
3 type cabinet like: bedroom wardrobe, shoe cabinet, TV cabinet
you need only one system SL60

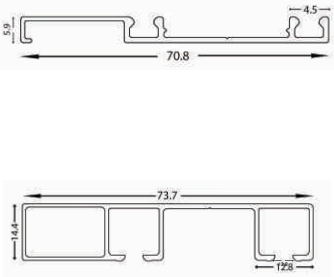

Sliding Roller Fitting

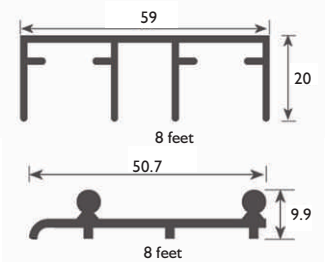
| Item Code | Product | Product Code | Item Description | UOM | Price (In Rs) | HSN Code | GST Tax Rate |
|------------|---|--------------|---|---------|---------------|----------|--------------|
| SL60 |  | 15215 | Sliding Roller for wooden Door (Set 4 roller & accessories) | Per Set | 1099 | 83024200 | 18% |
| |  | 15216 | Damper for slider roller (Set of 2 soft close damper & accessories) | Per Set | 449 | 83024200 | 18% |
| SL60 Track |  | 16084 | Track for Slider Roller (12 Feet) | Per Set | 3579.00 | 7604 | 18% |
| SL58 |  | 13901 | Roller For wooden Door : 2 Up, 2 Bottom and 2 Stoppers 50 Kg | Per Set | 439.00 | 83024200 | 18% |
| SL59 |  | 13902 | Soft close Roller For Wooden Door : 2 Up, 2 Bottom and 2 Stoppers, 2 Soft close 50 Kg | Per Set | 889.00 | 83024200 | 18% |
| |  | 13903 | UP & Down Track for SL 58 & SL 59 | Per Set | 1999.00 | 7604 | 18% |

Overlap Sliding





Two Door

Three Door

| Item Code | Product | Product Code | Product Code | Item Description | UOM | Price (In Rs) | HSN Code | GST Tax Rate |
|------------------------|---------|--|--------------|--|-----|---------------|----------|--------------|
| Overlap Sliding | | | | | | | | |
| | | 16984 | | SI22 Top Line Overlap (2 Door Fittings) 18-28mm; 50 Kg | Pcs | 6689.00 | 83024200 | 18% |
| | | 16983 | | SI22 Top Line Overlap; (3 Door Fittings) 18-28mm; 50 Kg | Pcs | 9699.00 | 83024200 | 18% |
| | | 13931 | | UP Track for SI22 Top Line Overlap Length of Track: 10 Feet | Pcs | 1949.00 | 7604 | 18% |
| | | 13932 | | Bottom Track for SL22 Top Line Overlap Length of Track: 10 Feet | Pcs | 1949.00 | 7604 | 18% |
| FOR TWO DOOR | | <p>Product Code 13929 Inner Door 13930 Outer Door 13931 Up Track 13932 Down Track</p> | | | | | | |
| FOR THREE DOOR | | <p>Product Code 13929 Inner Door 13930 Outer Door 13931 Up Track 13932 Down Track</p> | | | | | | |

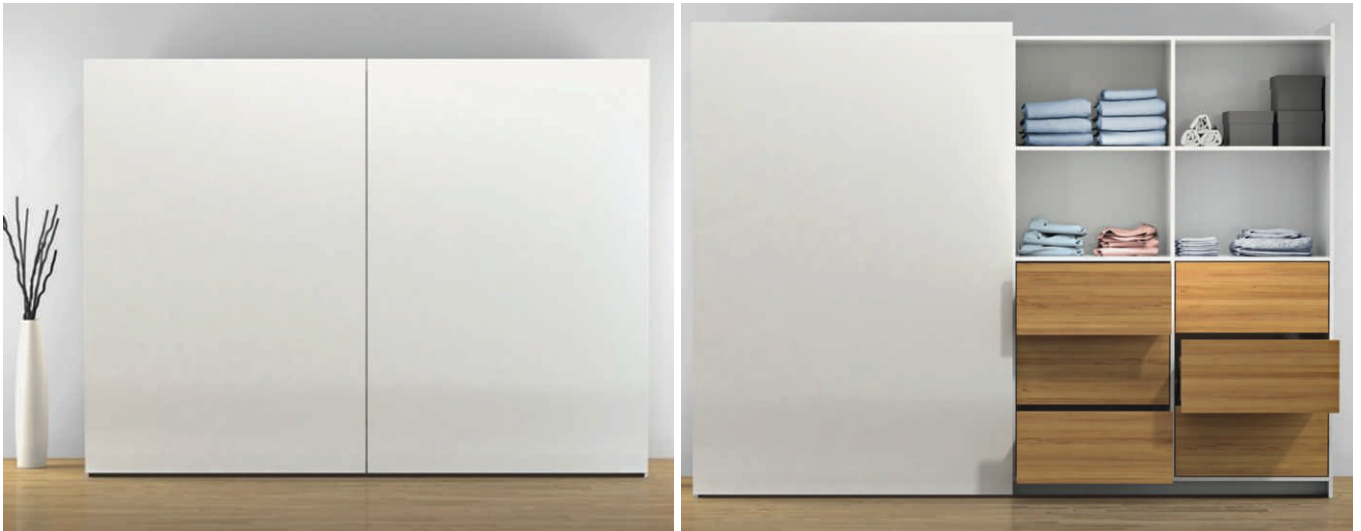
Inline Sliding



| Item Code | Product | Product Code | Item Description | UOM | Price (In Rs) | HSN Code | GST Tax Rate |
|-----------------------|---|--------------|---|-----|---------------|----------|--------------|
| Inline Sliding | | | | | | | |
| |  | 13928 | In Line Manual 2400mm; 18-50mm; 50 Kg | Pcs | 87599.00 | 83024200 | 18% |
| Automatic |  | 13983 | In Line Automatic 3000mm; 18-50mm; 60 Kg | Pcs | 249,000.00 | 83024200 | 18% |





Sliding Folding



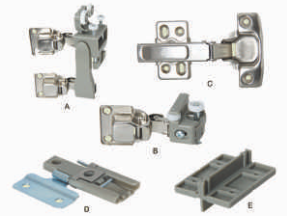

Sliding folding

| Item Code | Product | Product Code | Item Description | UOM | Price (In Rs) | HSN Code | GST Tax Rate |
|-----------|---------|--------------|------------------|-----|---------------|----------|--------------|
|-----------|---------|--------------|------------------|-----|---------------|----------|--------------|

Sliding Folding

| | | | | | | | |
|--------------|---|-------|--|---------|---------|----------|-----|
| SL 24 |  | 13984 | Sliding Folding (for 2 Folding Doors); 30 kg | Per Set | 2129.00 | 83024200 | 18% |
| Top Track | Length of Track: 10 Feet  | 13985 | Top Track | Per Pc | 1749.00 | 7604 | 18% |
| Bottom Track | Length of Track: 10 Feet  | 13986 | Bottom Track | Per Pc | 899.00 | 7604 | 18% |

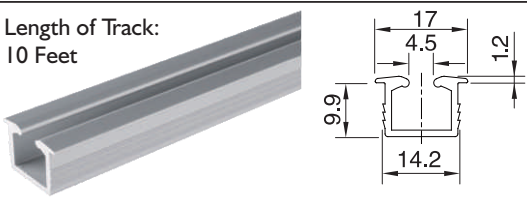
Wooden Sliding

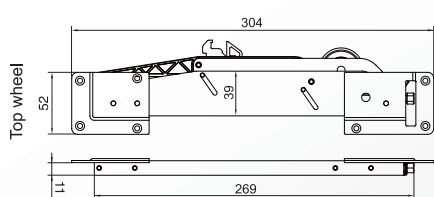
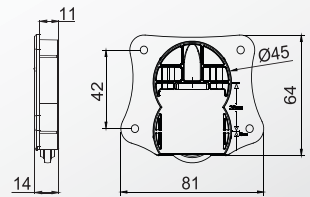
| | Product Code | Item Description | UOM | Price (In Rs) | HSN Code | GST Tax Rate |
|---|--------------|--|-----|---------------|---|--------------|
|  | 13926 | SL 23 Wooden Sliding Soft close; 50 Kg 1 Big Roller, 1 Small Roller | Set | 6899.00 | 83024200 | 18% |
| Length of Track: 10 Feet  | 13927 | Up and Bottom Track for SL23 | Pcs | 579.00 | 7604 | 18% |
|  width ≥ 460mm | |  Top wheel | | |  | |

Bifold



Up and over lift system

Bifold

UP and Over Lift system

Material: Zinc alloy + Plastic

Finish: Nickle Plating

Max Capacity: 6 Kg

Available: Up- turning wooden door
and aluminum -frame door



| Product Code | Item Description | UOM | Finish | Price (In Rs) | HSN Code | GST Tax Rate |
|--------------|-------------------------|---------|--------|---------------|----------|--------------|
| 15176 | Weight Capacity = 6 kg. | Per Set | SS | 7819.00 | 8302 | 18% |

Up Lift

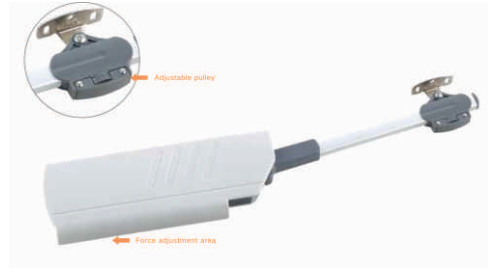

| Product Code | Item Description | UOM | Finish | Price (In Rs) | HSN Code | GST Tax Rate |
|--------------|-------------------------------|--------|--------|---------------|----------|--------------|
| 15169 | Weight Capacity = 5kg (left) | Per Pc | SS | 1699.00 | 8302 | 18% |
| 15226 | Weight Capacity = 5kg (right) | Per Pc | SS | 1699.00 | 8302 | 18% |



| Product Code | Item Description | UOM | Finish | Price (In Rs) | HSN Code | GST Tax Rate |
|--------------|---------------------------------|---------|--------|---------------|----------|--------------|
| 15227 | Weight Capacity = 3.5 to 4.8 Kg | Per Set | SS | 4699.00 | 8302 | 18% |



| Product Code | Item Description | UOM | Finish | Price (In Rs) | HSN Code | GST Tax Rate |
|--------------|-----------------------|--------|--------|---------------|----------|--------------|
| 15170 | Weight Capacity = 4kg | Per Pc | SS | 1149.00 | 8302 | 18% |

FASHION
IS TEMPORARY
CLASS
IS FOREVER



Wardrobe Fittings

PREMIUM WARDROBE FITTINGS



Wardrobe Fittings

LUXURY WARDROBE ACCESSORIES

WARDROBE ACCESSORIES



Garnishry Box with Seprator
(Matte Gold)
Dimension: 564x477x72 mm

| | |
|---------------|----------|
| Product Code | 13012 |
| Price (In Rs) | 9179.00 |
| UOM | Per Set |
| HSN Code | 73269099 |

Garnishry Box with Seprator
(Matte Gold)
Dimension: 864x477x72 mm

| | |
|---------------|----------|
| Product Code | 13020 |
| Price (In Rs) | 9999.00 |
| UOM | Per Set |
| HSN Code | 73269099 |



Shoes Rack
(Matte Gold)
Dimension: 564x477x145 mm

| | |
|---------------|----------|
| Product Code | 13015 |
| Price (In Rs) | 6469.00 |
| UOM | Per Set |
| HSN Code | 94032090 |



Shoes Rack
(Matte Gold)
Dimension: 864x477x145 mm

| | |
|---------------|----------|
| Product Code | 13016 |
| Price (In Rs) | 7999.00 |
| UOM | Per Set |
| HSN Code | 94032090 |



Clothes Basket

| | |
|---------------|----------|
| Product Code | 13017 |
| Price (In Rs) | 9999.00 |
| UOM | Per Set |
| HSN Code | 94032090 |

Wardrobe Fittings



IPWA01 Eight Layer Revolving Shoes Pack

Dimension: 46 x 76.4 x 191-211 cm
Cabinet Width: 800mm

| | |
|---------------|----------|
| Product Code | 7044 |
| Price (In Rs) | 25999.00 |
| UOM | Per Set |



IPWA03 Clothes Lifter

Dimension: 83-115 cm
Cabinet Width: 900
Weight Capacity: 18 Kg

| | |
|---------------|---------|
| Product Code | 7888 |
| Price (In Rs) | 4599.00 |
| UOM | Per Set |



IPWA05 Glass Sides Soft Closing Basket

Dimension: 83.5 x 14.2 x 46.5 cm

| | |
|---------------|---------|
| Product Code | 4674 |
| Price (In Rs) | 9389.00 |
| UOM | Per Set |



IPWA06 Chromed Iron Soft Closing Basket

Dimension: 83.5 x 14.2 x 46.6 cm

| | |
|---------------|----------|
| Product Code | 8954 |
| Price (In Rs) | 10929.00 |
| UOM | Per Set |



IPWA14 Rattan Basket Soft Closing

Dimension: 83.5 x 19 x 46.5 cm

| | |
|---------------|---------|
| Product Code | 3680 |
| Price (In Rs) | 9999.00 |
| UOM | Per Set |



Wardrobe Fittings



IPWA02

Revolving Clothes Pack

Dimension: W720 x H80-93.5 cm
Cabinet Width: 800 - 900

| | |
|---------------|---------|
| Product Code | 6534 |
| Price (In Rs) | 7299.00 |
| UOM | Per Set |

IPWA15

Clothes Rod with Induction Lamp

Dimension: 88.7 x 21.3 x 10.7 cm

| | |
|---------------|---------|
| Product Code | 8654 |
| Price (In Rs) | 5559.00 |
| UOM | Per Set |



IPWA10

Rattan Sides
3 Tier Soft Closing Basket

Dimension: 95.8x16.1 x46.5 cm

| | |
|---------------|----------|
| Product Code | 9113 |
| Price (In Rs) | 16999.00 |
| UOM | Per Set |



IPWA16

Multi Functional
Rotary Mirror

Dimension: 125.8x33.7x40.3cm

| | |
|---------------|----------|
| Product Code | 6674 |
| Price (In Rs) | 11999.00 |
| UOM | Per Set |

A modern kitchen scene featuring a pull-out cabinet. The cabinet is white and is pulled out, revealing several shelves. The top shelf holds a white knife block with black handles. Below it, a metal wire rack holds several glass jars with metal lids, containing various dry goods. The bottom shelf holds a white plastic bin containing several bottles of oil and vinegar, and a box of pasta. The kitchen has a white countertop with a stainless steel sink and faucet. In the background, there is a black oven with a digital display showing '8:06' and a stainless steel water dispenser. A tray of green apples sits on the countertop. The floor is dark grey tile.

Kitchen Fittings

Kitchen Fittings



Lehman Corner



Lehman Corner
Trays (left)
Dimension:
785x475x (600-730)mm

| | |
|---------------|----------|
| Product Code | 13002 |
| Price (In Rs) | 16499.00 |
| UOM | Per Set |
| HSN Code | 73269099 |

Lehman Corner
Trays (right)
Dimension:
785x475x (600-730)mm

| | |
|---------------|----------|
| Product Code | 13003 |
| Price (In Rs) | 16499.00 |
| UOM | Per Set |
| HSN Code | 73269099 |



5 Layers
Pantry Pull Out
Dimension: 414x500x1620mm

| | |
|---------------|----------|
| Product Code | 13004 |
| Price (In Rs) | 41159.00 |
| UOM | Per Set |
| HSN Code | 73269099 |



5 Layers
Pantry Pull Out
Dimension:
564x500x1620mm

| | |
|---------------|----------|
| Product Code | 13005 |
| Price (In Rs) | 43549.00 |
| UOM | Per Set |
| HSN Code | 73269099 |

Kitchen Fittings



Bottle Pull Out

Dimension: 100x485x520mm

| | |
|---------------|----------|
| Product Code | 13007 |
| Price (In Rs) | 4999.00 |
| UOM | Per Set |
| HSN Code | 73269099 |



Bottle & Spice Pull Out

Dimension: 135x460x580mm

Bottle & Spice Pull Out

Dimension: 235x460x580mm

Tall Unit

Dimension:
250x500x(1659-2059)mm

| | |
|---------------|----------|
| Product Code | 13006 |
| Price (In Rs) | 37999.00 |
| UOM | Per Set |
| HSN Code | 73269099 |

| | |
|---------------|----------|
| Product Code | 13008 |
| Price (In Rs) | 5999.00 |
| UOM | Per Set |
| HSN Code | 73269099 |

| | |
|---------------|----------|
| Product Code | 13009 |
| Price (In Rs) | 6699.00 |
| UOM | Per Set |
| HSN Code | 73269099 |



Aluminium Profiles

FURNITURE FITTINGS

Aluminium Profiles

Gola Profile



| Item Code | Product | Product Code | Item Description | Finish | UOM | Price (In Rs) | HSN Code | GST Tax Rate |
|--------------------------|---------|-------------------------------------|------------------|--------|----------------|---------------|----------|--------------|
| Gola Profile | | | | | | | | |
| Gola C | | 14871 | Gola Profile | Matt | Per 3Mt Length | 1299.00 | 7604 | 18% |
| | | 14872 | Gola Profile | Champ | Per 3Mt Length | 2099.00 | 7604 | 18% |
| | | 14873 | Gola Profile | SSB | Per 3Mt Length | 1909.00 | 7604 | 18% |
| | | 14874 | Gola Profile | SSC | Per 3Mt Length | 1939.00 | 7604 | 18% |
| | | 14875 | Gola Profile | Iron | Per 3Mt Length | 2099.00 | 7604 | 18% |
| Gola J | | 14876 | Gola Profile | Matt | Per 3Mt Length | 1129.00 | 7604 | 18% |
| | | 14877 | Gola Profile | Champ | Per 3Mt Length | 1669.00 | 7604 | 18% |
| | | 14878 | Gola Profile | SSB | Per 3Mt Length | 1469.00 | 7604 | 18% |
| | | 14879 | Gola Profile | SSC | Per 3Mt Length | 1469.00 | 7604 | 18% |
| | | 14880 | Gola Profile | Iron | Per 3Mt Length | 1669.00 | 7604 | 18% |
| Profile Connector | | | | | | | | |
| | 103695 | IPAPPC01 Connector for Framework | Per Set | 129.00 | 7604 | 18% | | |
| Gola Connector | | | | | | | | |
| | 16811 | Gola Connector | 4 Pc | 159.00 | 7604 | 18% | | |

Aluminium Profiles

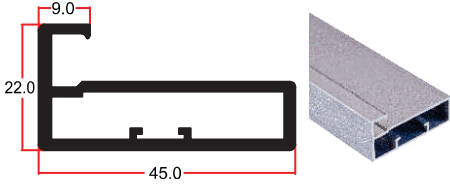
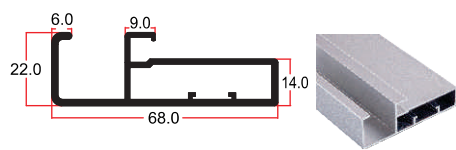
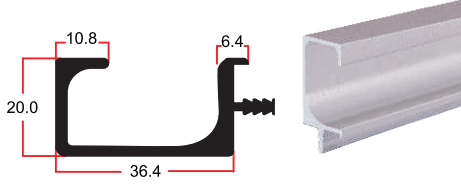

| Item Code | Product | Product Code | Item Description | Finish | UOM | Price (In Rs) | HSN Code | GST Tax Rate |
|--------------------------------------|---|--------------|--------------------------------|---------|----------------|---------------|----------|--------------|
| Frame Profile 45mm | | | | | | | | |
| IPAP01 |  | 4815 | Frame Profile45mm | Alu MAT | Per 3Mt Length | 1679.00 | 7604 | 18% |
| | | 7075 | Frame Profile 45mm | SSC | Per 3Mt Length | 2159.00 | 7604 | 18% |
| | | 5957 | Frame Profile 45mm | SSB | Per 3Mt Length | 2159.00 | 7604 | 18% |
| | | 14859 | Frame Profile 45mm | Iron | Per 3Mt Length | 2439.00 | 7604 | 18% |
| | | 14860 | Frame Profile 45mm | Champ | Per 3Mt Length | 2439.00 | 7604 | 18% |
| | | 15180 | Frame Profile 45mm | CP | Per 3Mt Length | 2439.00 | 7604 | 18% |
| handle for Frame Profile 45mm | | | | | | | | |
| IPAP02 |  | 5732 | Handle for frame Profile 45 mm | Alu MAT | Per 3Mt Length | 2379.00 | 7604 | 18% |
| | | 3683 | Handle for frame Profile 45 mm | SSC | Per 3Mt Length | 2699.00 | 7604 | 18% |
| | | 8788 | Handle for frame Profile 45 mm | SSB | Per 3Mt Length | 2699.00 | 7604 | 18% |
| | | 14861 | Handle for frame Profile 45 mm | Iron | Per 3Mt Length | 3099.00 | 7604 | 18% |
| | | 14862 | Handle for frame Profile 45 mm | Champ | Per 3Mt Length | 3099.00 | 7604 | 18% |
| | | 15181 | Handle for frame Profile 45 mm | CP | Per 3Mt Length | 3099.00 | 7604 | 18% |
| Handle G Profile | | | | | | | | |
| IPAP13 |  | 7483 | Handle G Profile | Matt | Per 3Mt Length | 1469.00 | 7604 | 18% |
| | | 7640 | Handle G Profile | SSC | Per 3Mt Length | 2089.00 | 7604 | 18% |
| | | 6269 | Handle G Profile | SSB | Per 3Mt Length | 2089.00 | 7604 | 18% |
| | | 14863 | Handle G Profile | Iron | Per 3Mt Length | 2329.00 | 7604 | 18% |
| | | 14864 | Handle G Profile | Champ | Per 3Mt Length | 2329.00 | 7604 | 18% |
| | | 15182 | Handle G Profile | CP | Per 3Mt Length | 2329.00 | 7604 | 18% |

Aluminium Profiles

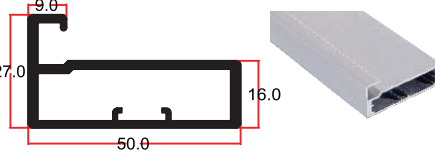
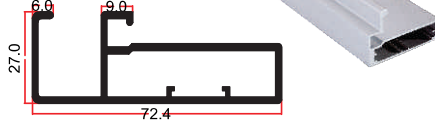
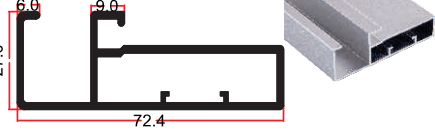
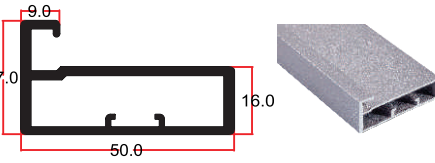
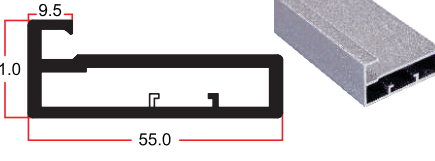

Other Frame Profiles

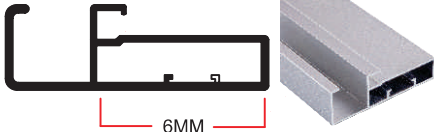
| Item Code | Product | Product Code | Item Description | Finish | UOM | Price (In Rs) | HSN Code | GST Tax Rate |
|---|---|--------------|---|---------|----------------|---------------|----------|--------------|
| IPAP07 |  | 4805 | Plain Profile 50mm | Alu MAT | Per 3Mt Length | 1779.00 | 7604 | 18% |
| | | 8474 | Plain Profile 50mm | SSC | Per 3Mt Length | 2199.00 | 7604 | 18% |
| | | 7172 | Plain Profile 50mm | SSB | Per 3Mt Length | 2259.00 | 7604 | 18% |
| Handle Profile 50mm | | | | | | | | |
| IPAP42 |  | 8935 | Handle Profile 50mm | Alu MAT | Per 3Mt Length | 1949.00 | 7604 | 18% |
| | | 4145 | Handle Profile 50mm | SSC | Per 3Mt Length | 2529.00 | 7604 | 18% |
| | | 7763 | Handle Profile 50mm | SSB | Per 3Mt Length | 2529.00 | 7604 | 18% |
| Handle Plain Profile 50mm for 8MM Glass | | | | | | | | |
| IPAP08 |  | 7024 | Handle Plain Profile 50 mm for 8 mm Glass | Alu MAT | Per 3Mt Length | 2989.00 | 7604 | 18% |
| | | 7900 | Handle Plain Profile 50 mm for 8 mm Glass | SSC | Per 3Mt Length | 3739.00 | 7604 | 18% |
| | | 8485 | Handle Plain Profile 50 mm for 8 mm Glass | SSB | Per 3Mt Length | 3739.00 | 7604 | 18% |
| Plain Profile 50mm 8mm Glass | | | | | | | | |
| IPAP43 |  | 7160 | Plain Profile 50mm | Alu MAT | Per 3Mt Length | 2249.00 | 7604 | 18% |
| | | 4332 | Plain Profile 50mm | SSC | Per 3Mt Length | 2819.00 | 7604 | 18% |
| | | 1780 | Plain Profile 50mm | SSB | Per 3Mt Length | 2819.00 | 7604 | 18% |
| Frame Profile 55mm | | | | | | | | |
| IPAP05 |  | 3522 | Frame Profile 55mm | Alu MAT | Per 3Mt Length | 2239.00 | 7604 | 18% |
| | | 7363 | Frame Profile 55mm | SSC | Per 3Mt Length | 2939.00 | 7604 | 18% |
| | | 6971 | Frame Profile 55mm | SSB | Per 3Mt Length | 2939.00 | 7604 | 18% |

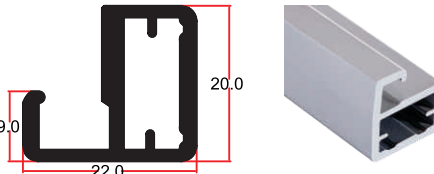
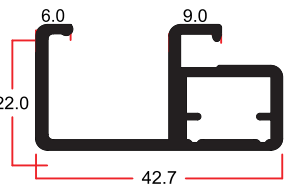
Aluminium Profiles

| Item Code | Product | Product Code | Item Description | Finish | UOM | Price (In Rs) | HSN Code | GST Tax Rate |
|--|---|--------------|--------------------------------------|---------|----------------|---------------|----------|--------------|
| Handle Frame Profile 55mm | | | | | | | | |
| IPAP06 |  | 5491 | Handle Frame Profile 55mm | Alu MAT | Per 3Mt Length | 3039.00 | 7604 | 18% |
| | | 7336 | Handle Frame Profile 55mm | SSC | Per 3Mt Length | 3329.00 | 7604 | 18% |
| | | 4846 | Handle Frame Profile 55mm | SSB | Per 3Mt Length | 3629.00 | 7604 | 18% |
| Curve Frame Profile 55mm | | | | | | | | |
| IPAP03 |  | 4244 | Curve Frame Profile 55mm | Alu MAT | Per 3Mt Length | 2839.00 | 7604 | 18% |
| | | 6314 | Curve Frame Profile 55mm | SSC | Per 3Mt Length | 3249.00 | 7604 | 18% |
| | | 6707 | Curve Frame Profile 55mm | SSB | Per 3Mt Length | 3249.00 | 7604 | 18% |
| Handle for Curve Frame Profile 55mm | | | | | | | | |
| IPAP04 |  | 8334 | Handle for Curve Frame Profile 55 mm | Alu MAT | Per 3Mt Length | 3379.00 | 7604 | 18% |
| | | 5543 | Handle for Curve Frame Profile 55 mm | SSC | Per 3Mt Length | 4399.00 | 7604 | 18% |
| | | 7503 | Handle for Curve Frame Profile 55 mm | SSB | Per 3Mt Length | 4399.00 | 7604 | 18% |
| Plain Profile 20mm | | | | | | | | |
| IPAP12 |  | 4428 | Plain Profile 20mm | Alu MAT | Per 3Mt Length | 1319.00 | 7604 | 18% |
| | | 5349 | Plain Profile 20mm | SSC | Per 3Mt Length | 1669.00 | 7604 | 18% |
| | | 6465 | Plain Profile 20mm | SSB | Per 3Mt Length | 1649.00 | 7604 | 18% |
| Handle Profile 20mm | | | | | | | | |
| IPAP39 |  | 4874 | Handle Profile 20mm | Alu MAT | Per 3Mt Length | 2069.00 | 7604 | 18% |
| | | 7757 | Handle Profile 20mm | SSC | Per 3Mt Length | 2599.00 | 7604 | 18% |
| | | 6059 | Handle Profile 20mm | SSB | Per 3Mt Length | 2599.00 | 7604 | 18% |

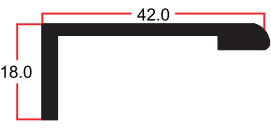
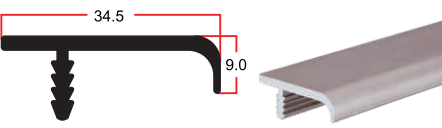
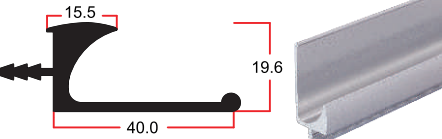
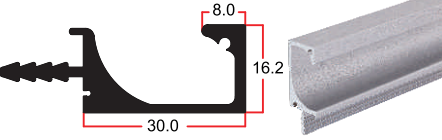

Aluminium Profiles

| Item Code | Product | Product Code | Item Description | Finish | UOM | Price (In Rs) | HSN Code | GST Tax Rate |
|---------------------------|---|--------------|--------------------|---------|----------------|---------------|----------|--------------|
| Handle Profile Width 42mm | | | | | | | | |
| IPAP14 |  | 4734 | Profile width 42mm | Alu MAT | Per 3Mt Length | 1309.00 | 7604 | 18% |
| | | 7686 | Profile width 42mm | SSC | Per 3Mt Length | 1759.00 | 7604 | 18% |
| | | 5666 | Profile width 42mm | SSB | Per 3Mt Length | 1759.00 | 7604 | 18% |
| Handle Profile width 35mm | | | | | | | | |
| IPAP16 |  | 5826 | Profile width 35mm | Alu MAT | Per 3Mt Length | 1589.00 | 7604 | 18% |
| | | 5342 | Profile width 35mm | SSC | Per 3Mt Length | 2109.00 | 7604 | 18% |
| | | 8404 | Profile width 35mm | SSB | Per 3Mt Length | 2109.00 | 7604 | 18% |
| | | 5826 | Profile width 35mm | Matt | Per 3Mt Length | 1589.00 | 7604 | 18% |
| | | 14865 | Profile width 35mm | Iron | Per 3Mt Length | 2309.00 | 7604 | 18% |
| | | 14866 | Profile width 35mm | Champ | Per 3Mt Length | 2309.00 | 7604 | 18% |
| Handle Profile width 40mm | | | | | | | | |
| IPAP19 |  | 8853 | Profile width 40mm | Alu MAT | Per 3Mt Length | 1929.00 | 7604 | 18% |
| | | 3676 | Profile width 40mm | SSC | Per 3Mt Length | 2419.00 | 7604 | 18% |
| | | 4669 | Profile width 40mm | SSB | Per 3Mt Length | 2419.00 | 7604 | 18% |
| Handle Profile width 30mm | | | | | | | | |
| IPAP20 |  | 4154 | Profile width 30mm | Alu MAT | Per 3Mt Length | 1549.00 | 7604 | 18% |
| | | 4606 | Profile width 30mm | SSC | Per 3Mt Length | 1699.00 | 7604 | 18% |
| | | 6141 | Profile width 30mm | SSB | Per 3Mt Length | 1919.00 | 7604 | 18% |
| Handle Profile width 50mm | | | | | | | | |
| IPAP21 |  | 5120 | Profile width 50mm | Alu MAT | Per 3Mt Length | 1639.00 | 7604 | 18% |
| | | 8965 | Profile width 50mm | SSC | Per 3Mt Length | 2199.00 | 7604 | 18% |
| | | 8228 | Profile width 50mm | SSB | Per 3Mt Length | 2199.00 | 7604 | 18% |

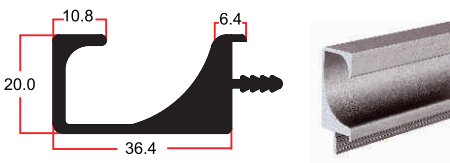
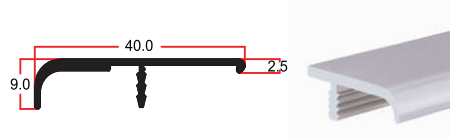
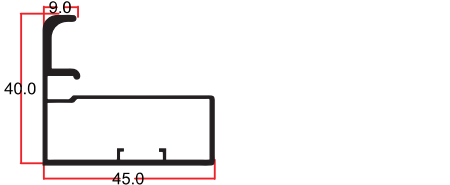
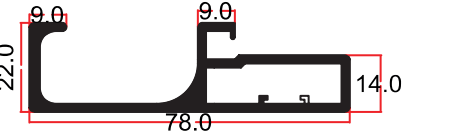
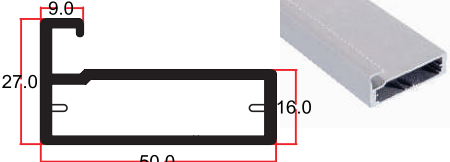

Aluminium Profiles

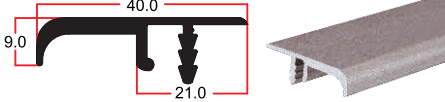
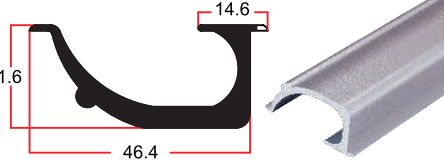
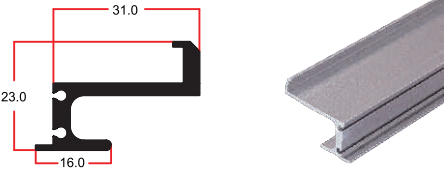
| Item Code | Product | Product Code | Item Description | Finish | UOM | Price (In Rs) | HSN Code | GST Tax Rate |
|--|---|--------------|--|---------|----------------|---------------|----------|--------------|
| Handle G Profile(Heavy) | | | | | | | | |
| IPAP13H |  | 5001 | Handle G Profile | Alu MAT | Per 3Mt Length | 2519.00 | 7604 | 18% |
| | | 6009 | Handle G Profile | SSC | Per 3Mt Length | 3079.00 | 7604 | 18% |
| Handle Profile width 40mm | | | | | | | | |
| IPAP38 |  | 7376 | Profile width 40mm | Alu MAT | Per 3Mt Length | 1389.00 | 7604 | 18% |
| | | 7587 | Profile width 40mm | SSC | Per 3Mt Length | 1809.00 | 7604 | 18% |
| | | 6788 | Profile width 40mm | SSB | Per 3Mt Length | 1809.00 | 7604 | 18% |
| Handle (Curve) For Frame Profile 45mm | | | | | | | | |
| IPAP09 |  | 7877 | Handle (curve) for Frame Profile 45 mm | Alu MAT | Per 3Mt Length | 2279.00 | 7604 | 18% |
| | | 6114 | Handle (curve) for Frame Profile 45 mm | SSC | Per 3Mt Length | 2819.00 | 7604 | 18% |
| | | 8053 | Handle (curve) for Frame Profile 45 mm | SSB | Per 3Mt Length | 2819.00 | 7604 | 18% |
| G Handle for Frame Profile 45mm | | | | | | | | |
| IPAP10 |  | 7911 | G Handle for Frame Profile 45 mm | Alu MAT | Per 3Mt Length | 3099.00 | 7604 | 18% |
| | | 5629 | G Handle for Frame Profile 45 mm | SSC | Per 3Mt Length | 4059.00 | 7604 | 18% |
| | | 3677 | G Handle for Frame Profile 45 mm | SSB | Per 3Mt Length | 4059.00 | 7604 | 18% |
| Plain Profile 50mm | | | | | | | | |
| IPAP11 |  | 6822 | Plain Profile 50mm | Alu MAT | Per 3Mt Length | 1719.00 | 7604 | 18% |
| | | 5157 | Plain Profile 50mm | SSC | Per 3Mt Length | 2199.00 | 7604 | 18% |
| | | 7914 | Plain Profile 50mm | SSB | Per 3Mt Length | 2399.00 | 7604 | 18% |

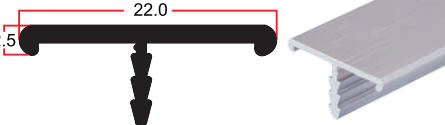
Aluminium Profiles

| Item Code | Product | Product Code | Item Description | Finish | UOM | Price (In Rs) | HSN Code | GST Tax Rate |
|---------------------------|---|--------------|---------------------|---------|----------------|---------------|----------|--------------|
| Handle Profile width 40mm | | | | | | | | |
| IPAP15 |  | 4248 | Profile width 40mm | Alu MAT | Per 3Mt Length | 1319.00 | 7604 | 18% |
| | | 6190 | Profile width 40mm | SSC | Per 3Mt Length | 1779.00 | 7604 | 18% |
| | | 6405 | Profile width 40mm | SSB | Per 3Mt Length | 1779.00 | 7604 | 18% |
| Handle Profile width 46mm | | | | | | | | |
| IPAP17 |  | 6169 | Profile width 46mm | Alu MAT | Per 3Mt Length | 1839.00 | 7604 | 18% |
| | | 5221 | Profile width 46mm | SSC | Per 3Mt Length | 1979.00 | 7604 | 18% |
| | | 7810 | Profile width 46mm | SSB | Per 3Mt Length | 2179.00 | 7604 | 18% |
| Handle Profile width 35mm | | | | | | | | |
| IPAP18 |  | 7466 | Profile width 35mm | Alu MAT | Per 3Mt Length | 1259.00 | 7604 | 18% |
| | | 4721 | Profile width 35mm | SSC | Per 3Mt Length | 1589.00 | 7604 | 18% |
| | | 5936 | Profile width 35mm | SSB | Per 3Mt Length | 1589.00 | 7604 | 18% |
| Edge Profiles | | | | | | | | |
| Edge T Profile 19mm | | | | | | | | |
| IPAP40 |  | 6175 | Edge T Profile 19mm | Alu MAT | Per 3Mt Length | 459.00 | 7604 | 18% |
| | | 7538 | Edge T Profile 19mm | SSC | Per 3Mt Length | 659.00 | 7604 | 18% |
| | | 6419 | Edge T Profile 19mm | SSB | Per 3Mt Length | 659.00 | 7604 | 18% |
| Edge T Profile 22mm | | | | | | | | |
| IPAP22 |  | 5367 | Edge T Profile 22mm | Alu MAT | Per 3Mt Length | 459.00 | 7604 | 18% |
| | | 4086 | Edge T Profile 22mm | SSC | Per 3Mt Length | 659.00 | 7604 | 18% |
| | | 8609 | Edge T Profile 22mm | SSB | Per 3Mt Length | 769.00 | 7604 | 18% |
| | | 14867 | Edge T Profile 22mm | Iron | Per 3Mt Length | 769.00 | 7604 | 18% |
| | | 14868 | Edge T Profile 22mm | Champ | Per 3Mt Length | 769.00 | 7604 | 18% |

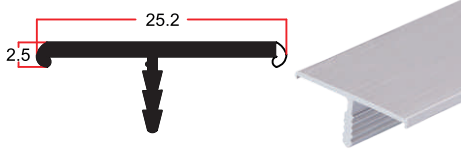
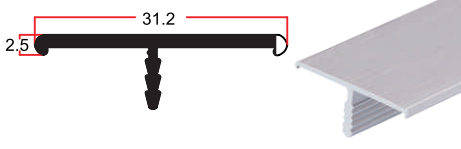
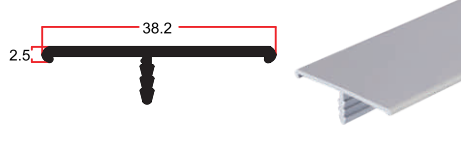
Aluminium Profiles

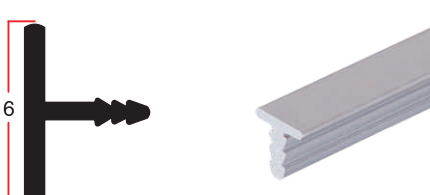
| Item Code | Product | Product Code | Item Description | Finish | UOM | Price (In Rs) | HSN Code | GST Tax Rate |
|--------------------------|---|--------------|--------------------------|---------|----------------|---------------|----------|--------------|
| Edge T Profile 25mm | | | | | | | | |
| IPAP23 |  | 7240 | Edge T Profile25mm | Alu MAT | Per 3Mt Length | 629.00 | 7604 | 18% |
| | | 8827 | Edge T Profile25mm | SSC | Per 3Mt Length | 859.00 | 7604 | 18% |
| | | 7471 | Edge T Profile25mm | SSB | Per 3Mt Length | 959.00 | 7604 | 18% |
| Edge T Profile 31.2mm | | | | | | | | |
| IPAP24 |  | 6715 | Edge T Profile 31.2mm | Alu MAT | Per 3Mt Length | 709.00 | 7604 | 18% |
| | | 8395 | Edge T Profile 31.2mm | SSC | Per 3Mt Length | 979.00 | 7604 | 18% |
| | | 5929 | Edge T Profile 31.2mm | SSB | Per 3Mt Length | 979.00 | 7604 | 18% |
| Edge T Profile 38.2mm | | | | | | | | |
| IPAP25 |  | 7633 | Edge T Profile 38.2mm | Alu MAT | Per 3Mt Length | 799.00 | 7604 | 18% |
| | | 6094 | Edge T Profile 38.2mm | SSC | Per 3Mt Length | 989.00 | 7604 | 18% |
| | | 6461 | Edge T Profile 38.2mm | SSB | Per 3Mt Length | 989.00 | 7604 | 18% |
| | | 14869 | Edge T Profile 38.2mm | Iron | Per 3Mt Length | 1109.00 | 7604 | 18% |
| | | 14870 | Edge T Profile 38.2mm | Champ | Per 3Mt Length | 1109.00 | 7604 | 18% |
| Edge T Profile 44.2mm | | | | | | | | |
| IPAP26 |  | 4472 | Edge T Profile 44.2mm | Alu MAT | Per 3Mt Length | 859.00 | 7604 | 18% |
| | | 5081 | Edge T Profile 44.2mm | SSC | Per 3Mt Length | 1089.00 | 7604 | 18% |
| | | 4840 | Edge T Profile 44.2mm | SSB | Per 3Mt Length | 1089.00 | 7604 | 18% |
| Edge Small T Profile 6mm | | | | | | | | |
| IPAP27 |  | 6960 | Edge Small T Profile 6mm | Alu MAT | Per 3Mt Length | 199.00 | 7604 | 18% |
| | | 7988 | Edge Small T Profile 6mm | SSC | Per 3Mt Length | 209.00 | 7604 | 18% |

Aluminium Profiles

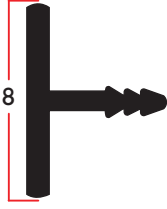
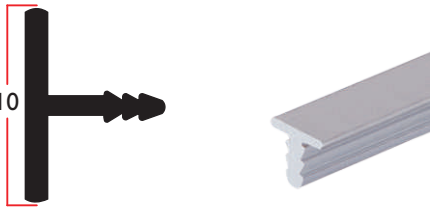
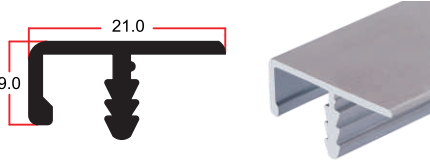
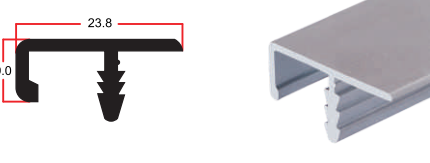
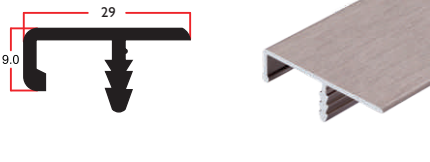
| Item Code | Product | Product Code | Item Description | Finish | UOM | Price (In Rs) | HSN Code | GST Tax Rate |
|---------------------------|---|--------------|---------------------------|---------|----------------|---------------|----------|--------------|
| Edge Small T Profile 8mm | | | | | | | | |
| IPAP28 |  | 1832 | Edge Small T Profile 8mm | Alu MAT | Per 3Mt Length | 239.00 | 7604 | 18% |
| | | 1833 | Edge Small T Profile 8mm | SSC | Per 3Mt Length | 249.00 | 7604 | 18% |
| Edge Small T Profile 10mm | | | | | | | | |
| IPAP29 |  | 6637 | Edge Small T Profile 10mm | Alu MAT | Per 3Mt Length | 259.00 | 7604 | 18% |
| | | 4168 | Edge Small T Profile 10mm | SSC | Per 3Mt Length | 269.00 | 7604 | 18% |
| Edge F Profile 20mm | | | | | | | | |
| IPAP33 |  | 6773 | Edge F Profile 20mm | Alu MAT | Per 3Mt Length | 489.00 | 7604 | 18% |
| | | 4370 | Edge F Profile 20mm | SSC | Per 3Mt Length | 659.00 | 7604 | 18% |
| | | 7967 | Edge F Profile 20mm | SSB | Per 3Mt Length | 659.00 | 7604 | 18% |
| Edge F Profile 23.8mm | | | | | | | | |
| IPAP34 |  | 7691 | Edge F Profile 23.8mm | Alu MAT | Per 3Mt Length | 629.00 | 7604 | 18% |
| | | 7589 | Edge F Profile 23.8mm | SSC | Per 3Mt Length | 859.00 | 7604 | 18% |
| | | 5078 | Edge F Profile 23.8mm | SSB | Per 3Mt Length | 859.00 | 7604 | 18% |
| Edge F Profile 29.8mm | | | | | | | | |
| IPAP35 |  | 7223 | Edge F Profile 29.8mm | Alu MAT | Per 3Mt Length | 669.00 | 7604 | 18% |
| | | 8634 | Edge F Profile 29.8mm | SSC | Per 3Mt Length | 969.00 | 7604 | 18% |
| | | 4078 | Edge F Profile 29.8mm | SSB | Per 3Mt Length | 969.00 | 7604 | 18% |

Aluminium Profiles

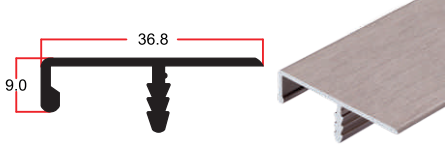
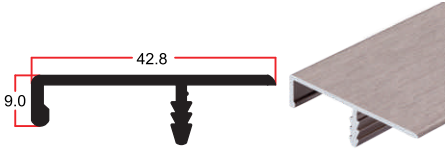
| Item Code | Product | Product Code | Item Description | Finish | UOM | Price (In Rs) | HSN Code | GST Tax Rate |
|-----------|---|-----------------------|-----------------------|---------|----------------|---------------|----------|--------------|
| | | Edge F Profile 36.8mm | | | | | | |
| IPAP36 |  | 8944 | Edge F Profile 36.8mm | Alu MAT | Per 3Mt Length | 799.00 | 7604 | 18% |
| | | 8103 | Edge F Profile 36.8mm | SSC | Per 3Mt Length | 1089.00 | 7604 | 18% |
| | | 5017 | Edge F Profile 36.8mm | SSB | Per 3Mt Length | 1089.00 | 7604 | 18% |
| | | Edge F Profile 42.8mm | | | | | | |
| IPAP37 |  | 8486 | Edge F Profile 42.8mm | Alu MAT | Per 3Mt Length | 1009.00 | 7604 | 18% |
| | | 3446 | Edge F Profile 42.8mm | SSC | Per 3Mt Length | 1209.00 | 7604 | 18% |
| | | 8393 | Edge F Profile 42.8mm | SSB | Per 3Mt Length | 1209.00 | 7604 | 18% |

Terms & Conditions

1. The price list supersedes all our previous price lists.
2. All prices are Ex Factory.
3. Prices are subjected to change without prior notice.
4. The Above prices are applicable w.e.f. July 2021 .
5. Orders should be as per guidelines of the company and in writing.
6. Discount may vary from product to product in price list.
7. Any Damaged goods or short material received must be immediately noticed and discrepancy must be clearly mentioned on delivery receipt.
8. No material for return shall be accepted by the company, in case valid claim is not filed in writing within 1 month



IPSA Business (India) Pvt. Ltd.

57/1/17-18 Site IV, Industrial Area, Sahibabad 201010, Distt. Ghaziabad. (U.P.) India

Customercare Division: Ph +91 120 4536600 (100 Lines) Fax: +91-120-4536666

E-mail: customercare@ipsaindia.com, ipsa@ipsaindia.com

Website: www.ipsaindia.com

Price List

w.e.f. July 2021

Version 5.1







DOOR ARCHITECTURAL HARDWARE

INDEX

| | Page No | | Page No |
|--------------------------------------|---------|---------------------------------|---------|
| Intelligent Locks | 03-07 | Moderna Handle Series | 27-32 |
| Bubble Series | 08-09 | Iris Handle Series | 33-41 |
| Modrena Series Locks & Cylinder | 10 | Brass Mortise Combo Locksets | 42 |
| Iris Series Mortise Locks & Cylinder | 11-14 | Brass Pull Handles | 43-44 |
| Nighty latch & Cylindrical Lock | 15-16 | Glass Pull Handles | 45 |
| Sliding Multi Locks | 17 | Towerbolt | 46-48 |
| Furniture Locks | 18 | Aldrops & SS Screws | 49-50 |
| Door Closers | 19 | Door Buffers & Door Accessories | 51 |
| Lord Series | 20-21 | Door Stoppers | 52 |
| Luxos Series | 22 | Door Hinges | 53-54 |
| Swarovski Series | 23-24 | Door Handle | 55 |
| Premium Handle Brass | 25 | Glass Fitting | 56-57 |
| Tube Mortise Handle & Escutcheons | 26 | | |

Handles Chart

IRIS SERIES

| | Page No. |
|---|----------|
| Azure | 39 |
| Canary | 37 |
| Cherry | 38 |
| Elima | 37 |
| Falu | 36 |
| Grey | 40 |
| Jade | 41 |
| kafe | 38 |
| Lace | 36 |
| Mynza | 40 |
| Navy  | 34 |
| Peach | 39 |
| Peru  | 35 |
| Shyne  | 35 |
| Sky | 41 |
| Teal  | 34 |





| | |
|--------|----|
| Tomato | 30 |
| Xinith | 32 |

LUXOS SERIES

PREMIUM HANDLE BRASS

| | Page No. | | Page No. |
|---------|----------|---------|----------|
| Darcy | 24 | Angela | 25 |
| Ellesse | 24 | Dea | 25 |
| Ethen | 24 | Edina | 25 |
| Mach | 24 | Elko | 25 |
| Olly | 24 | Flo | 25 |
| Prius | 24 | Isy | 25 |
| Ryne | 24 | Martina | 25 |
| | | Opasa | 25 |
| | | Sadiya | 25 |
| | | Silvana | 25 |
| | | Skyla | 25 |
| | | Sylvia | 25 |
| | | Velma | 25 |

MODERNA SERIES

| | |
|---|----|
| Bone | 29 |
| Bud | 32 |
| Capri | 32 |
| Ceil | 32 |
| Chilli  | 28 |
| Cyan | 31 |
| Edo | 32 |
| Flax | 30 |
| Lawrence | 32 |
| Olive | 30 |
| Plum | 31 |
| Russet | 31 |
| Sangria | 29 |
| Scarlet | 29 |
| Smoke  | 30 |
| Scarlet | 31 |
| Tiffany  | 28 |
| Rhino  | 28 |

SWAROVSKI

| | |
|--------|----|
| Atara | 24 |
| Alina | 24 |
| Auro | 23 |
| Casa | 24 |
| Crysta | 23 |
| Emma | 24 |
| Macro | 23 |
| Pico | 23 |
| Puma | 24 |
| Siro | 24 |
| Suva | 24 |
| Zelda | 24 |











LORD SERIES

| | |
|-----|----|
| Ady | 21 |
| Aly | 21 |
| Bao | 21 |
| Bey | 21 |
| Emo | 21 |
| Noa | 21 |
| Oak | 21 |
| Oza | 21 |
| Rio | 21 |
| Sol | 21 |

Series 30



Smart Door Lock

-  Fingerprint
-  Password
-  RFID Card
-  Key
-  Bluetooth
-  OTP Access
-  Time Bound Access
-  Android
-  iOS
-  *Add ON
IPSA Smartway

Technical Specifications

| | |
|------------------------|--|
| Materials | Zinc Alloy |
| Lock Size | 158*63mm |
| Unlocking way | Fingerprint, Password, Card, Bluetooth, Mechanical Key |
| Colour | Black |
| Doors Applicable | Wood Door |
| Door Thickness to Fit | 30-60mm |
| Working Voltage | 6V (4XAA Batteries) |
| Low Wattage Alarm | Below 4.8V |
| Battery Life Span | Support 10,000 Times of Locking & Unlocking |
| Working Temperature | -20°C - 70°C |
| Working Humidity | 20% - 90% |
| Data Capacity | 300 Date for Fingerprint+ Password+Card |
| Card Type | Mfi Card |
| Distance to Sense Card | <25mm |

| | |
|--------------|--------------|
| Product Code | 14708 |
| Description | Series 30 |
| Finish | Black |
| UOM | Per Set |
| HSN Code | 8301 |
| GST | 18% |
| Price | 27999 |

Unlock with your smart phone



- OTP access for your guest
- Time bound access
- Unlock with key



Unlock with Password or Fingerprint

Add On
IPSA Smartway



Unlock your door from anywhere

| Code | Description | Finish | UOM | Price | Inner Pak | Master Pak |
|-------|---------------|--------|-----|-------------|-----------|------------|
| 15200 | IPSA Smartway | Grey | Pcs | 9990 | 1 | 4 |



Unlock with RFID Card

TC-02



Hotel Lock

- Encoder , Software , Power Saver
- Low Battery And Emergency Power
- Mechanical 2 key override



| Code | Description | UOM | Price | Inner Pack |
|-------|------------------------------|--------|-------|------------|
| 1894 | Hotel Lock (Right Outside) | Per Pc | 16499 | 1 |
| 1919 | Hotel Lock (Right Inside) | Per Pc | 16499 | 1 |
| 1895 | Hotel Lock (Left Outside) | Per Pc | 16499 | 1 |
| 1896 | Hotel Lock (Left Inside) | Per Pc | 16499 | 1 |
| 1897 | Encoder & Software for TC 02 | Per Pc | 34999 | 1 |
| 4259 | Card | Per Pc | 399 | 1 |
| 10212 | Power Saver | Per Pc | 4999 | 1 |

Basic Function of Hotel Electronic Lock

Main Functions: E. g. Level Control: Different management levels are set in accordance with user's requirements

- A. Guard card: To open all the room locks whether it is in deadbolt working or not when using it. (For senior securers in emergency).
- B. Manager card(Centrally-control card): To open all the room locks except in deadbolt condition. (For senior management personnel of hotels).
Waiter/Waitress card to come into the room and provide services for clients in the specified time except in dead bolt condition.
- D. Floor manager card: To open all room locks of the designated storey except in deadbolt working. (For middle ranked management personnel of hotels)

- E. Cleaner card: To come into the room to do cleaning in the specified time(For cleaners).
- F. Limit all card: when guests check out and leave the hotel, often the waiters come into the room to check the room and confirm, insert it into the lock, the guest cards will be invalid
- G. Guest card: To record the information of clients and open the designated room lock with in its validity. (For guests).
- H. Record card: To check the lock-opening records(For management personnel).
- I. Limited card: When any valid card is missing, a restriction card can be made through system management software and cardmaking machine to cause the previous valid card to become void.

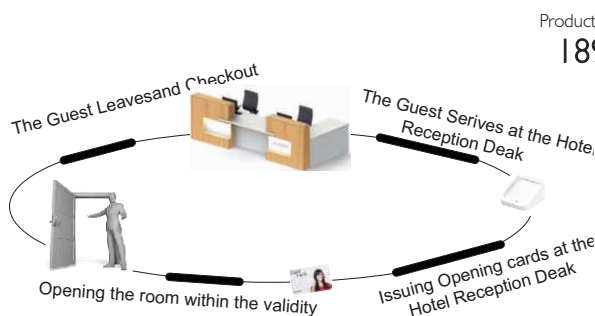

Two main function of electronic locks:
Diagram 1: Function of time setting open

Product Code
1897



Software

34,999 MRP.

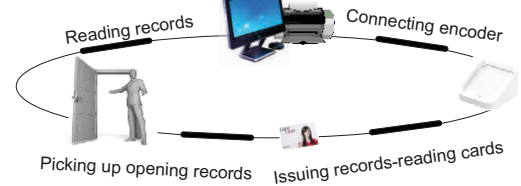

Diagram2: Function of reading and looking up the opening records of locks



WARDROBE LOCK

| Code | Description | UOM | Price | Inner Pack |
|------|----------------------------|---------|-------|------------|
| 1924 | Intelligent Wardrobe Lock | Per Set | 6999 | 1 |
| 1941 | Extra Power Unit for WL 01 | Per Pc | 1999 | 1 |



TC-02

DIY Lock

- Low Battery And Emergency Power
- Mechanical 2 key override
- Stainless steel structure

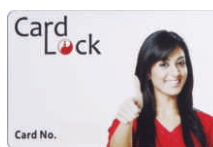

| Code | Description | UOM | Price | Inner Pack | Master pack |
|------|--------------------------|---------|-------|------------|-------------|
| 1920 | DIY Lock (Right Outside) | Per Set | 16499 | 1 | 9 |
| 1898 | DIY Lock (Right Inside) | Per Set | 16499 | 1 | 9 |
| 1900 | DIY Lock (Left Outside) | Per Set | 16499 | 1 | 9 |
| 1899 | DIY Lock (Left Inside) | Per Set | 16499 | 1 | 9 |
| 7951 | Management card for TC02 | Per Pc | 3999 | 1 | 9 |
| 8735 | DIY Card for TC02 | Per Pc | 399 | 1 | 9 |

KP-01



Keypad & Card Lock

- Smart Touchpad
- Low Battery And Emergency Power
- Password Capacity 200
- Card Capacity 60
- Mechanical 2 key override

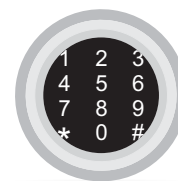

| Code | Description | UOM | Price | Inner Pack | Master pack |
|------|---------------------------|---------|-------|------------|-------------|
| 7473 | Keypad & Card Lock(Left) | Per Set | 24999 | 1 | 8 |
| 2518 | Keypad & Card Lock(Right) | Per Set | 24999 | 1 | 8 |

TC-03



DIY Lock

- Encoder , Software , Power Saver
- Low Battery And Emergency Power
- Mechanical 2 key override

| Code | Description | UOM | Price | Inner Pack | Master pack |
|------|--------------------------|--------|-------|------------|-------------|
| 1923 | DIY Lock (Right Outside) | Per Pc | 17999 | 1 | 8 |
| 1902 | DIY Lock (Right Inside) | Per Pc | 17999 | 1 | 8 |
| 1903 | DIY Lock (Left Outside) | Per Pc | 17999 | 1 | 8 |
| 1904 | DIY Lock (Left Inside) | Per Pc | 17999 | 1 | 8 |



FP-02

1. Pure Alloy mechanical rational structure enable for using more than 10 years.
2. It is very easy to change batteries in the lock, just need several minutes on one lock.
3. Using 4x1.5V standard alkaline batteries.
4. Unlock ways: Fingerprint or Keypad or Mechanical key.
5. The fired users can be deleted individually without any effect on the application of the other users.
6. If the fingerprint is not input correctly. The handle is free handle; it can provide the door against opening by force, and prolong the using of mechanism of the lock.
7. Fingerprint user capacity 150 and password capacity 78.
8. Especially suitable for installation by nonprofessionals.
9. A special hood is adopted to protect the fingerprint reader which is the most import part of the fingerprint door lock.
10. Just need to pull up the hood and put the fingerprint on the reader to open the door.
11. No need to input the passwords by pressing the several buttons of the keypad.



| Product Code | Description | Finish | UOM | Price | Inner Pack | Master pack |
|--------------|---------------------------|--------|---------|-------|------------|-------------|
| 6842 | Fingerprint & Keypad Lock | SS | Per Set | 29999 | 1 | 8 |

FP-03

1. Pure Alloy mechanical rational structure enable for using more than 10 years.
2. Easy to replace batteries, only take few seconds.
3. Using 4x1.5V standard alkaline batteries.
4. Unlock ways: Fingerprint or Keypad or Mechanical key
5. The fired users can be deleted individually without any effect on the application of the other users.
6. If the fingerprint is not input correctly. The handle is free handle; it can provide the door against opening by force, and prolong the using of the mechanism of the lock.
7. Fingerprint user capacity 150 and password capacity 78.
8. Especially suitable for installation by nonprofessionals.
9. A special hood is adopted to protect the fingerprint reader which is the most important part of the fingerprint door lock.
10. Just need to pull up the hood and put the fingerprint on the reader to open the door. No need to input the passwords by pressing the several buttons of the keypad.



| Product Code | Description | Finish | UOM | Price | Inner Pack | Master pack |
|--------------|---------------------------|--------|---------|-------|------------|-------------|
| 4963 | Fingerprint & Keypad Lock | SS | Per Set | 29999 | 1 | 8 |

Introducing bubble series

Electronic Safe

Premium Home/Office | Compact Digital Lockers

The Dual-Lock Tamper-Proof Home Safe from high-grade steel with a book system and battery backup. The minimalist design is discreet and effective-compact security system to protect your cash and value personal items against thieves and intruders.





Premium Home/Office | Compact Digital Lockers

**bubble** Keypad + Key

| | |
|------------------|------------------------|
| Code | 15146 |
| Item Description | IPSA Bubble Safe Black |
| UOM | Pcs |
| Dimension | 350mm x 280mm x 250mm |
| Weight | 11 Kg |
| Price | 12990 |

**bubble face** Fingerprint + Keypad + Key

| | |
|------------------|-----------------------------|
| Code | 15148 |
| Item Description | IPSA Bubble face Safe Black |
| UOM | Pcs |
| Dimension | 350mm x 280mm x 250mm |
| Weight | 11 Kg |
| Price | 19990 |

**bubble eye** Fingerprint + Key

| | |
|------------------|----------------------------|
| Code | 15147 |
| Item Description | IPSA Bubble Eye Safe Black |
| UOM | Pcs |
| Dimension | 350mm x 280mm x 250mm |
| Weight | 11 Kg |
| Price | 16499 |

**bubble swipe** Digital card + Keypad

| | |
|------------------|------------------------------|
| Code | 15172 |
| Item Description | IPSA Bubble Swipe Safe Black |
| UOM | Pcs |
| Dimension | 350mm x 430mm x 165mm |
| Weight | 14 Kg |
| Price | 21999 |

MODRENA SERIES LOCKS & CYLINDER



ML 13

CY Lock
Backset : 85 x 50mm

| Code | Finish | Price (In Rs) Per Pc |
|-------|-----------|-------------------------|
| 5189 | SS | 709 |
| 3539 | ATQ | 749 |
| 16634 | MTS | 849 |
| 16635 | ROSE GOLD | 1199 |



ML 08

Baby Latch
Backset : 50mm

| Code | Finish | Price (In Rs) Per Pc |
|-------|-----------|-------------------------|
| 8469 | SS | 519 |
| 7578 | ATQ | 589 |
| 16650 | MTS | 629 |
| 16651 | ROSE GOLD | 869 |



ML 16

CY Lock 60 Backset
Backset : 85mm X 60mm

| Code | Finish | Price (In Rs) Per Pc |
|-------|-----------|-------------------------|
| 8484 | SS | 1099 |
| 8458 | ATQ | 1149 |
| 16638 | MTS | 1249 |
| 16639 | ROSE GOLD | 1449 |



ML 05E

Eco Deadlock with
Escutcheons
Backset : 55mm

| Code | Finish | Price (In Rs) Per Pc |
|------|--------|-------------------------|
| 6753 | SS | 559 |
| 4465 | ATQ | 599 |



ML 25

4 Bolt CY Heavy Duty Lock
Backset : 85mm X 60mm

| Code | Finish | Price (In Rs) Per Pc |
|------|--------|-------------------------|
| 5041 | SS | 1289 |
| 4131 | ATQ | 1419 |



ML 18

Eco CYS Lock 2 Bolt
Backset : 45mm X 45mm

| Code | Finish | Price (In Rs) Per Pc |
|-------|-----------|-------------------------|
| 4245 | SS | 599 |
| 6772 | ATQ | 599 |
| 16644 | MTS | 699 |
| 16645 | ROSE GOLD | 999 |

Series - 600

TH Series Computer Key

| Item Description | | UOM | | SS | ATQ | MTS | ROSE GOLD |
|---|------------------------------|--------|-------|-------|-------|-------|-----------|
|  | Both Side Key | | Code | 8002 | 6065 | 16210 | 16211 |
| | 60 mm Both Side Key Cylinder | Per Pc | Price | 699 | 739 | 849 | 909 |
| | | | Code | 4529 | 7272 | 16212 | 16214 |
| | 70 mm Both Side Key Cylinder | Per Pc | Price | 769 | 809 | 919 | 989 |
| | | | Code | 13377 | 13378 | 16215 | 16216 |
| 80 mm Both Side Key Cylinder | Per Pc | Price | | 1059 | 1099 | 1209 | 1269 |

| Item Description | | UOM | | SS | ATQ | MTS | ROSE GOLD |
|--|---------------------------|--------|-------|-------|-------|-------|-----------|
|  | One Side Key & Knob | | Code | 7201 | 6312 | 16204 | 16205 |
| | 60 mm One Side Key & Knob | Per Pc | Price | 789 | 829 | 939 | 999 |
| | | | Code | 6408 | 8187 | 16206 | 16207 |
| | 70 mm One Side Key & Knob | Per Pc | Price | 859 | 899 | 999 | 1069 |
| | | | Code | 15975 | 15974 | 16208 | 16209 |
| 80 mm One Side Key & Knob | Per Pc | Price | | 1149 | 1199 | 1299 | 1399 |

| Item Description | | UOM | | SS | ATQ | MTS | ROSE GOLD |
|---|----------------------------|--------|-------|-------|-------|-------|-----------|
|  | Coin & Knob | | Code | 8301 | 4801 | 16682 | 16683 |
| | 60 mm One Side Coin & Knob | Per Pc | Price | 699 | 739 | 849 | 909 |
| | | | Code | 7313 | 5151 | 16686 | 16687 |
| | 70 mm One Side Coin & Knob | Per Pc | Price | 769 | 809 | 919 | 989 |
| | | | Code | 15971 | 15970 | 16690 | 16691 |
| 80 mm One Side Coin & Knob | Per Pc | Price | | 1059 | 1099 | 1209 | 1269 |

Inner Pack & Master Pack : 1 / 20



ML 15

Super Premium SS304 Lock
Backset : 85mm x 50mm

| Code | Finish | Price (In Rs) Per Pc |
|------|--------|----------------------|
| 5933 | SS | 1129.00 |
| 8538 | SL | 1129.00 |
| 4144 | ATQ | 1129.00 |



ML 24

Heavy Spring CY Lock Body
Backset: 85mmX50mm

| Code | Finish | Price (In Rs) Per Pc |
|------|--------|----------------------|
| 5003 | SS | 1999 |
| 5935 | SL | 1999 |
| 5507 | ATQ | 1999 |



ML 29

SS304 Premium Sash Lock
Backset : 85mmx 60mm



| Code | Finish | Price (In Rs) Per Pc |
|-------|--------|----------------------|
| 13438 | SS | 2299.00 |



ML 12

4 Bolt CY Lock
Backset : 85mmx50mm

| Code | Finish | Price (In Rs) Per Pc |
|------|--------|----------------------|
| 6137 | SS | 1499.00 |
| 7923 | SL | 1499.00 |
| 4475 | ATQ | 1499.00 |



ML 14L

Double Door Lock Left
Backset : 85mm X 50mm

| Code | Finish | Price (In Rs) Per Pc |
|------|--------|----------------------|
| 5529 | SS | 2019.00 |
| 4426 | SL | 2019.00 |
| 8461 | ATQ | 2019.00 |



ML 03

Cross Key Sliding Lock
Backset : 20mm

| Code | Finish | Price (In Rs) Per Pc |
|------|--------|----------------------|
| 6014 | SS | 1069.00 |
| 8100 | SL | 1069.00 |
| 8855 | ATQ | 1069.00 |



ML 22

3 Bolt CY Lock
Backset : 85mm X 50mm

| Code | Finish | Price (In Rs) Per Pc |
|------|--------|----------------------|
| 7984 | SS | 709.00 |
| 5184 | SL | 799.00 |
| 7855 | ATQ | 749.00 |



ML 14R

Double Door Lock Right
Backset : 85mm X 50mm

| Code | Finish | Price (In Rs) Per Pc |
|------|--------|----------------------|
| 4695 | SS | 2019.00 |
| 3805 | SL | 2019.00 |
| 8601 | ATQ | 2019.00 |



ML 19

CY Sliding Lock
Backset : 21mm

| Code | Finish | Price (In Rs) Per Pc |
|------|--------|----------------------|
| 8250 | SS | 699.00 |
| 4007 | SL | 699.00 |
| 7518 | ATQ | 699.00 |



ML 07

KY Deadlock
Backset : 37mm

| Code | Finish | Price (In Rs) Per Pc |
|------|--------|----------------------|
| 6712 | SS | 519.00 |
| 6656 | SL | 519.00 |
| 7388 | ATQ | 519.00 |



ML 23

CY Lock Body Deadlock
Backset : 85mmX50mm

| Code | Finish | Price (In Rs) Per Pc |
|------|--------|----------------------|
| 8920 | SS | 1149.00 |
| 4186 | SL | 1149.00 |
| 4135 | ATQ | 1149.00 |



ML 21

CY Latch Lock for Panic Bar
Backset : 85mm X 50mm

| Code | Finish | Price (In Rs) Per Pc |
|------|--------|----------------------|
| 5882 | SS | 999.00 |
| 4558 | SL | 999.00 |
| 8642 | ATQ | 999.00 |

IRIS SERIES MORTISE LOCKS & CYLINDER

Inner Pack & Master Pack : 1 / 20

ML 26**Magnetic Sash Lock**

Backset : 50mm X 85 mm

13441

2099.00/-

Magnetic Latch

**NEW
PRODUCT****ML 27****Double Hook Lock**
Backset : 40mm**NEW
PRODUCT**

| Code | Finish | Price (In Rs) Per Pc |
|-------|--------|-------------------------|
| 13440 | SS | 1319.00 |
| | SL | |
| | ATQ | |

**ML 20****Cross Key 4 Bolt Deadlock**
Backset : 50mm

| Code | Finish | Price (In Rs) Per Pc |
|------|--------|-------------------------|
| 7884 | SS | 1099.00 |
| 2727 | SL | 1099.00 |
| 4306 | ATQ | 1099.00 |

**ML11****KY Eco Lock**
Backset : 45mm

| Code | Finish | Price (In Rs) Per Pc |
|------|--------|-------------------------|
| 6117 | SS | 669.00 |
| 5140 | SL | 669.00 |
| 3548 | ATQ | 669.00 |

**ML 28****Sliding Door Lock with
Inserted Handle**
Backset: 55 mm**NEW
PRODUCT**

| Code | Finish | Price (In Rs) Per Pc |
|-------|--------|-------------------------|
| 13439 | SS | 2999.00 |

**ML 30****Premium Deadlock
with Escutcheons**
Backset: 55mm**NEW
PRODUCT**

| Code | Finish | Price (In Rs) Per Pc |
|-------------|--------|-------------------------|
| IPSF1005237 | SS | 499.00 |

**ML09****Passage CY Lock**
Backset : 45mm

| Code | Finish | Price (In Rs) Per Pc |
|------|--------|-------------------------|
| 6690 | SS | 999.00 |
| 5514 | SL | 999.00 |
| 8801 | ATQ | 999.00 |

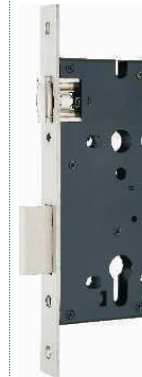
**ML 04****CY Emergency Lock**
Backset : 55mm

| Code | Finish | Price (In Rs) Per Pc |
|------|--------|-------------------------|
| 3934 | SS | 1569.00 |
| 3540 | SL | 1569.00 |
| 3266 | ATQ | 1569.00 |





Unlock a better life...

IRIS SERIES MORTISE LOCKS & CYLINDER

13



Series - 100

Super Max High Security

| Item Description | | UOM | | SS | SL | ATQ | Inner pack | Master pack |
|---|---------------------------|--------|-------|-------------|-------------|-------------|------------|-------------|
| Both Side Key | | | Code | 8577 | 7384 | 4478 | | |
|  | 60 mm Both Side Key | Per Pc | Price | 1799 | 1799 | 1799 | 10 | 100 |
| | | | Code | 4911 | 4749 | 6120 | | |
| | 70 mm Both Side Key | Per Pc | Price | 1999 | 1999 | 1999 | | |
| | | | Code | 3889 | 8863 | 7390 | | |
| | 80 mm Both Side Key | Per Pc | Price | 2199 | 2199 | 2199 | | |
| | | | | | | | | |
| One Side Key & Knob | | | Code | 7220 | 6516 | 1624 | | |
|  | 60 mm One Side Key & Knob | Per Pc | Price | 1899 | 1899 | 1899 | 10 | 100 |
| | | | Code | 8807 | 5668 | 3886 | | |
| | 70 mm One Side Key & Knob | Per Pc | Price | 2099 | 2099 | 2099 | | |
| | | | Code | 5769 | 3622 | 4879 | | |
| | 80 mm One Side Key & Knob | Per Pc | Price | 2299 | 2299 | 2299 | | |
| | | | | | | | | |



Series - 200

Brass Normal Key

| Item Description | | UOM | | SS | ATQ | Inner pack | Master pack |
|---|---------------------|--------|-------|-------------|-------------|------------|-------------|
| Both Side Key | | | | | | | |
|  | 60 mm Both Side Key | Per Pc | | 5702 | 8285 | 10 | 100 |
| | | | Price | 909 | 959 | | |
| | 70 mm Both Side Key | Per Pc | Code | 5230 | 8984 | 10 | 100 |
| | | | Price | 1029 | 1079 | | |
| One Side Key | | | | | | | |
|  | 60 mm Key & Knob | Per Pc | Code | 5757 | 3443 | 10 | 100 |
| | | | Price | 989 | 1039 | | |
| | 70 mm Key & Knob | Per Pc | Code | 6537 | 4759 | 10 | 100 |
| | | | Price | 1099 | 1149 | | |
| Coin & Knob | | | | | | | |
|  | 60 mm Coin & Knob | Per Pc | Code | 5650 | 3579 | 10 | 100 |
| | | | Price | 909 | 959 | | |
| | 70 mm Coin & Knob | Per Pc | Code | 9013 | 9008 | 10 | 100 |
| | | | Price | 1029 | 1079 | | |

Series - 300



Brass Computer Key

| Item Description | | UOM | | SS | SL | ATQ | Inner pack | Master pack |
|---|-------------------------------|--------|-------------|-------------|-------------|-------------|------------|-------------|
| Both Side Key | | | Code | 6271 | 7108 | 3946 | | |
|  | 60 mm Both Side Key Cylinder | Per Pc | Price | 1229 | 1279 | 1279 | 10 | 100 |
| | | | Code | 8449 | 7857 | 6200 | | |
| | 70 mm Both Side Key Cylinder | Per Pc | Price | 1299 | 1349 | 1349 | | |
| | | | Code | 4626 | 4638 | 6775 | | |
| | 80 mm Both Side Key Cylinder | Per Pc | Price | 1419 | 1469 | 1469 | | |
| | | | Code | 7301 | 5960 | 3585 | | |
| 90 mm Both Side Key Cylinder | Per Pc | Price | 1679 | 1729 | 1729 | | | |
| | | Code | 3893 | 5945 | 6381 | | | |
| | 100 mm Both Side Key Cylinder | Per Pc | Price | 1849 | 1899 | 1899 | | |
| | | | | | | | | |
| One Side Key | | | Code | 4573 | 6587 | 5449 | | |
|  | 60 mm One Side Key & Knob | Per Pc | Price | 1299 | 1349 | 1349 | 10 | 100 |
| | | | Code | 4658 | 7104 | 4869 | | |
| | 70 mm One Side Key & Knob | Per Pc | Price | 1369 | 1419 | 1419 | | |
| | | | Code | 4812 | 5016 | 5174 | | |
| | 80 mm One Side Key & Knob | Per Pc | Price | 1489 | 1539 | 1539 | | |
| | | | Code | 7101 | 4803 | 3416 | | |
| 90 mm One Side Key & Knob | Per Pc | Price | 1749 | 1799 | 1799 | | | |
| | | Code | 4127 | 4146 | 4125 | | | |
| | 100 mm One Side Key & Knob | Per Pc | Price | 1919 | 1969 | 1969 | | |

IRIS SERIES MORTISE LOCKS & CYLINDER



Series - 400

Half Cylinder

| Item Description | | UOM | | SS | SL | ATQ | Inner pack | Master pack |
|--|-------------------------|--------|-------|-------|-------|-------|------------|-------------|
| Half Cylinder (KEY)  | 60 mm Half Cylinder Key | Per Pc | Code | 8800 | 1968 | 3601 | 10 | 100 |
| | | | Price | 759 | 759 | 759 | | |
| | 70 mm Half Cylinder Key | Per Pc | Code | 13095 | 13096 | 13097 | | |
| | | | Price | 829 | 829 | 829 | | |
| | 80 mm Half Cylinder Key | Per Pc | Code | 13098 | 13099 | 13100 | | |
| | | | Price | 959 | 959 | 959 | | |
| | 90 mm Half Cylinder Key | Per Pc | Code | 13101 | 13102 | 13103 | | |
| | | Price | 1159 | 1159 | 1159 | | | |
| 100 mm Half Cylinder Key | Per Pc | Code | 13104 | 13105 | 13106 | | | |
| | | Price | 1229 | 1229 | 1229 | | | |
| Half Cylinder (KNOB)  | 60 mm Half Cylinder | Per Pc | Code | 6567 | 7133 | 5596 | 10 | 100 |
| | | | Price | 759 | 759 | 759 | | |
| | 70 mm Half Cylinder | Per Pc | Code | 13107 | 13108 | 13109 | | |
| | | | Price | 829 | 829 | 829 | | |
| | 80 mm Half Cylinder | Per Pc | Code | 13110 | 13111 | 13112 | | |
| | | | Price | 959 | 959 | 959 | | |
| | 90 mm Half Cylinder | Per Pc | Code | 13113 | 13114 | 13115 | | |
| | | Price | 1159 | 1159 | 1159 | | | |
| 100 mm Half Cylinder | Per Pc | Code | 13116 | 13117 | 13118 | | | |
| | | Price | 1229 | 1229 | 1229 | | | |

Series - 500

Eco Series Normal Key

| Both Side Key | | | | | | | | |
|---|---------------------|--------|-------|------|------|------|----|-----|
|  | 60 mm Both side key | Per Pc | Code | 8856 | 7027 | 6657 | 10 | 100 |
| | | | Price | 679 | 719 | 719 | | |
| | 70 mm Both Side Key | Per Pc | Code | 5794 | 7742 | 4733 | 10 | 100 |
| | | | Price | 749 | 789 | 789 | | |
| One Side Key | | | | | | | | |
|  | 60 mm Key & Knob | Per Pc | Code | 8338 | 7656 | 6077 | 10 | 100 |
| | | | Price | 769 | 809 | 809 | | |
| | 70 mm Key & Knob | Per Pc | Code | 6026 | 6255 | 4429 | 10 | 100 |
| | | | Price | 839 | 879 | 879 | | |

Master Keys Systems

Normal Master Key



| Product Code | Item Description | Price (In Rs) |
|--------------|---|---------------|
| 1976 | Upto 20 Cylinders 2 Keys / Set | 269 |
| 1980 | From 21 to 50 Cylinders 3 Keys / Set | 379 |
| 1985 | From 51 & Above Cylinders 4 Keys / Set | 469 |
| 1989 | Extra Key | 500 |

Normal Grand Master Key



| Product Code | Item Description | Price (In Rs) |
|--------------|---|---------------|
| 1978 | Upto 20 Cylinders 2 Keys / Set | 578 |
| 1981 | From 21 to 50 Cylinders 3 Keys / Set | 758 |
| 1987 | From 51 & Above Cylinders 4 Keys / Set | 978 |
| 1990 | Extra Key | 920 |

Ultra Master Key



| Product Code | Item Description | Price (In Rs) |
|--------------|---|---------------|
| 1998 | Upto 20 Cylinders 2 Keys / Set | 349 |
| 2004 | From 21 to 50 Cylinders 3 Keys / Set | 449 |
| 2012 | From 51 & Above Cylinders 4 Keys / Set | 579 |
| 2014 | Extra Key | 600 |

Ultra Grand Master Key



| Product Code | Item Description | Price (In Rs) |
|--------------|---|---------------|
| 2001 | Upto 20 Cylinders 2 Keys / Set | 648 |
| 2005 | From 21 to 50 Cylinders 3 Keys / Set | 848 |
| 2013 | From 51 & Above Cylinders 4 Keys / Set | 1108 |
| 2016 | Extra Key | 1150 |

NIGHT LATCHES



Inner Pack & Master Pack : 1 / 10

Dead Lock 1C

Normal Key - 3 Keys
Knob on Inside
Small Deadlock



| Code | Finish | Price (In Rs) Per Set |
|------|--------|--------------------------|
| 4141 | SS | 1169.00 |
| 7618 | ATQ | 1349.00 |

Dead Lock 2C

Normal Key - 3 Keys
Both Side Key
Small Deadlock

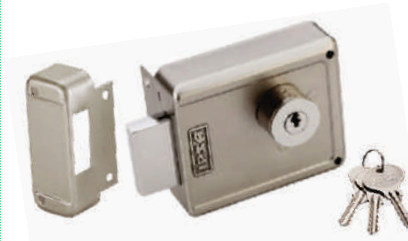

| Code | Finish | Price (In Rs) Per Set |
|------|--------|--------------------------|
| 6811 | SS | 1499.00 |
| 3591 | ATQ | 1499.00 |

Normal Key - 3 Keys

Night Latch Normal Key 1C

Night Latch Knob
on Inside



| Code | Finish | Price (In Rs) Per Set |
|------|--------|--------------------------|
| 4833 | SS | 1539.00 |
| 8754 | ATQ | 1799.00 |

Night Latch Normal Key 2C

Night Latch
Both Side Key



| Code | Finish | Price (In Rs) Per Set |
|------|--------|--------------------------|
| 6501 | SS | 1949.00 |
| 5453 | ATQ | 2099.00 |

14 Pin Ultra Keys-4 Keys

Night Latch Dimple Key 1C

Night Latch Knob
on Inside



| Code | Finish | Price (In Rs) Per Set |
|------|--------|--------------------------|
| 7018 | SS | 1749.00 |
| 7130 | ATQ | 2039.00 |

Night Latch Dimple Key 2C

Night Latch Twin Bolt
Both Side Key



| Code | Finish | Price (In Rs) Per Set |
|------|--------|--------------------------|
| 7453 | SS | 2369.00 |
| 8924 | ATQ | 2499.00 |

Tribolt With Latch 1C

3 Bolt (Try Bolt Lock
with Reversible Latch)
Knob Inside



| Code | Finish | Price (In Rs) Per Set |
|------|--------|--------------------------|
| 4417 | SS | 3099.00 |

Tribolt With Latch 1C

3 Bolt (Try Bolt Lock
with Reversible Latch)
Knob Inside



| Code | Finish | Price (In Rs) Per Set |
|------|--------|--------------------------|
| 4773 | ATQ | 3749.00 |

Tribolt With Latch 2C

3 Bolt (Try Bolt Lock
with Reversible Latch)
Lockable Knob Inside



| Code | Finish | Price (In Rs) Per Set |
|------|--------|--------------------------|
| 4414 | SS | 3599.00 |

Tribolt With Latch 2C

3 Bolt (Try Bolt Lock
with Reversible Latch)
Knob Inside



| Code | Finish | Price (In Rs) Per Set |
|------|--------|--------------------------|
| 4575 | ATQ | 3959.00 |

NIGHT LATCH

Inner Pack & Master Pack : 1 / 10

Tribolt Deadlock 1C

3 Bolt Deadlock
Knob inside

| Code | Finish | Price (In Rs) Per Set |
|------|--------|--------------------------|
| 8810 | SS | 2759.00 |

Tribolt Deadlock 1C

3 Bolt Deadlock
Knob inside

| Code | Finish | Price (In Rs) Per Set |
|------|--------|--------------------------|
| 7425 | ATQ | 3269.00 |

Tribolt Deadlock 2C

3 Bolt Deadlock
Lockable Knob inside

| Code | Finish | Price (In Rs) Per Set |
|------|--------|--------------------------|
| 6642 | SS | 3149.00 |

Tribolt Deadlock 2C

3 Bolt Deadlock
Lockable Knob inside

| Code | Finish | Price (In Rs) Per Set |
|------|--------|--------------------------|
| 7773 | ATQ | 3469.00 |

SS Cylindrical Locks

Inner Pack & Master Pack : 1 / 24

| | Computer Key | | SS ATQ SB PB | | | | | | | | |
|--|---------------------|---------|--------------|-----------|-----------|------------|-----------|------------|-----------|------------|--|
| | | | Code | Price | Code | Price | Code | Price | | | |
| | 60 mm ET (Entrance) | Per Set | Code 4222 | Price 899 | Code 7041 | Price 1069 | Code 8718 | Price 1069 | Code 7683 | Price 1069 | |
| | 70 mm ET (Entrance) | Per Set | Code 8046 | Price 999 | Code 4610 | Price 1169 | Code 4825 | Price 1169 | Code 8303 | Price 1169 | |
| | With Out Key | | | | | | | | | | |
| | 60 mm BK (Bathroom) | Per Set | Code 3658 | Price 849 | Code 8778 | Price 999 | Code 7719 | Price 999 | Code 4166 | Price 999 | |
| | 70 mm BK (Bathroom) | Per Set | Code 5683 | Price 899 | Code 7850 | Price 1059 | Code 7705 | Price 1059 | Code 3643 | Price 1059 | |

Cylindrical Locks SS304

| | Ultra Computer Key | | SS | | ATQ | | |
|--|---------------------|---------|-----------|------------|-----------|------------|--|
| | | | Code | Price | Code | Price | |
| | 60 mm ET (Entrance) | Per Set | Code 5623 | Price 1099 | Code 4411 | Price 1299 | |
| | 70 mm ET (Entrance) | Per Set | Code 6212 | Price 1199 | Code 8373 | Price 1399 | |
| | With Out Key | | | | | | |
| | 60 mm BK (Bathroom) | Per Set | Code 8771 | Price 1049 | Code 6402 | Price 1249 | |
| | 70 mm BK (Bathroom) | Per Set | Code 7974 | Price 1149 | Code 5978 | Price 1349 | |

| | Latch | | SS | |
|--|---------------------------|--------|------------|-----------|
| | | | Code | Price |
| | 60 mm Heavy Duty Latch ET | Per Pc | Code 12249 | Price 149 |
| | 70 mm Heavy Duty Latch ET | Per Pc | Code 7991 | Price 159 |

SLIDING MULTI LOCKS

NEW PRODUCT



Slider Multi Drawer locks



Push lock
for Sliding wardrobe

| Code | Price (In Rs) Per Pc | Inner Pack | Master Pack |
|-------|----------------------|------------|-------------|
| 14903 | 169.00 | 12 | 120 |



Sliding lock for wooden wardrobe door

| Code | Price (In Rs) Per Pc | Inner Pack | Master Pack |
|-------|----------------------|------------|-------------|
| 14904 | 389.00 | 10 | 100 |



Sliding Lock for Alu./Wood Sliding Door Left

| Code | Price (In Rs) Per Pc | Inner Pack | Master Pack |
|-------|----------------------|------------|-------------|
| 14905 | 329.00 | 10 | 100 |



Sliding Lock for Alu./Wood for Sliding Door Right

| Code | Price (In Rs) Per Pc | Inner Pack | Master Pack |
|-------|----------------------|------------|-------------|
| 14906 | 329.00 | 10 | 100 |

Brown Lock

Drawer Lock With Normal Key



NEW PRODUCT

| Code | Price (In Rs) Per Pc | Inner Pack | Master Pack |
|-------|----------------------|------------|-------------|
| 14125 | 105.00 | 10 | 600 |



DL 01

Cupboard Lock with Brass Bolt
Size: 22mm

| Code | Price (In Rs) Per Pc | Inner Pack | Master Pack |
|------|----------------------|------------|-------------|
| 6311 | 599.00 | 10 | 50 |

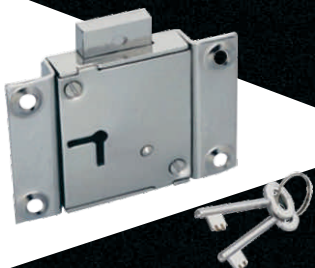

Universal Lock

| Code | Inner Pack | Master Pack | Price (In Rs) Per Pc |
|-------|------------|-------------|----------------------|
| 12692 | 10 | 80 | 359.00 |

FURNITURE LOCKS

Finish : SS

Sliding Lock Wardrobe lock

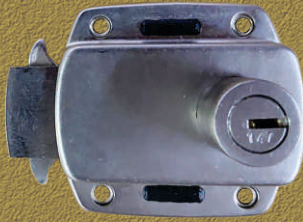

| Code | Size | Price (In Rs) Per Pc |
|------|------|-------------------------|
| 6981 | 25 | 629.00 |
| 6983 | 32 | 679.00 |

DL 02



Wardrobe Lock

| Code | Size (In mm) | Price (In Rs) Per Pc | Inner Pack | Master Pack |
|------|-----------------|-------------------------|---------------|----------------|
| 4130 | 22 | 399.00 | 10 | 80 |

DL 03



Wardrobe Lock

| Code | Size (In mm) | Price (In Rs) Per Pc | Inner Pack | Master Pack |
|------|-----------------|-------------------------|---------------|----------------|
| 4616 | 22 | 579.00 | 10 | 80 |
| 5332 | 25 | 539.00 | 10 | 80 |

MP 22

Computer Key
Drawer Lock

| Code | Size (In mm) | Price (In Rs) Per Pc | Inner Pack | Master Pack |
|------|-----------------|-------------------------|---------------|----------------|
| 7970 | 22 | 249.00 | 10 | 80 |

MP 32

Computer Key
Drawer Lock

| Code | Size (In mm) | Price (In Rs) Per Pc | Inner Pack | Master Pack |
|------|-----------------|-------------------------|---------------|----------------|
| 5339 | 32 | 279.00 | 10 | 80 |

MP 91

Eco Multipurpose Lock
Size: 22mm

| Code | Price (In Rs) Per Pc | Inner Pack | Master Pack |
|------|-------------------------|---------------|----------------|
| 7598 | 95.00 | 10 | 120 |

MP 92

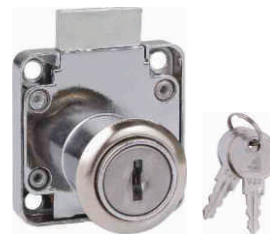
Standard Multipurpose
Lock
Size: 22mm

| Code | Price (In Rs) Per Pc | Inner Pack | Master Pack |
|------|-------------------------|---------------|----------------|
| 4169 | 149.00 | 10 | 240 |

MPCY 01

Heavy Cylindrical
Multi Lock
Size: 22mm

| Code | Price (In Rs) Per Pc | Inner Pack | Master Pack |
|------|-------------------------|---------------|----------------|
| 5819 | 299.00 | 10 | 50 |

Armour Lock



Drawer Lock With Dimple Key

| Code | Size (In mm) | Price (In Rs) Per Pc | Inner Pack | Master Pack |
|------|-----------------|-------------------------|---------------|----------------|
| 5652 | 20 | 359.00 | 1 | 100 |
| 7225 | 25 | 389.00 | 1 | 100 |

Armour Lock



Wardrobe Lock With Dimple Key

| Code | Size (In mm) | Price (In Rs) Per Pc | Inner Pack | Master Pack |
|------|-----------------|-------------------------|---------------|----------------|
| 8052 | 22-25 | 519.00 | 1 | 40 |
| 5478 | 30-32 | 539.00 | 1 | 40 |
| 7246 | 36-38 | 599.00 | 1 | 40 |

Armour Lock



Wardrobe Lock With Normal Key

| Code | Size (In mm) | Price (In Rs) Per Pc | Inner Pack | Master Pack |
|------|-----------------|-------------------------|---------------|----------------|
| 6915 | 25 | 229.00 | 1 | 100 |
| 6916 | 32 | 279.00 | 1 | 100 |
| 6917 | 38 | 319.00 | 1 | 100 |

DOOR CLOSERS

Inner Pack & Master Pack - 1 & 10

**DC 50**

50kg with adjustable Arm
EN Standard : EN3#
Door width (mm): 1000
Door weight (kg): 50
Durability test : 5,00,000 cycles
Arm: Easy adjustable arm

| Code | Finish | Price (In Rs) Per Pc |
|------|--------|-------------------------|
| 3789 | SS | 1579.00 |

**DC 70**

70kg with adjustable Arm
EN Standard : EN4#
Door width (mm): 1100
Door weight (kg): 70
Durability test : 5,00,000 cycles
Arm: Easy adjustable arm

| Code | Finish | Price (In Rs) Per Pc |
|------|--------|-------------------------|
| 4959 | SS | 1779.00 |

**DC 75**

75kg (Dome Type)
EN Standard : EN4#
Door width (mm): 1100
Door weight (kg): 75
Durability test : 5,00,000 cycles
Arm: Top arm

| Code | Finish | Price (In Rs) Per Pc |
|------|--------|-------------------------|
| 5560 | SS | 2499.00 |

**DC 80/P**

80kg with Palmet Arm
EN Standard : EN2#
Door width (mm): 1100
Door weight (kg): 80
Durability test : 5,00,000 cycles
Arm: Palmet arm

| Code | Finish | Price (In Rs) Per Pc |
|------|--------|-------------------------|
| 5907 | ATQ | 4069.00 |

**DC 100/P**

100kg with Palmet Arm
EN Standard : EN2#
Door width (mm): 1100
Door weight (kg): 100
Durability test : 5,00,000 cycles
Arm: Palmet arm

| Code | Finish | Price (In Rs) Per Pc |
|------|--------|-------------------------|
| 4025 | SS | 4369.00 |

**DC 120/E**

120kg with Easy Arm
EN Standard : EN6#
Door width (mm): 1400
Door weight (kg): 120 - 140
Durability test : 5,00,000 cycles
Arm: Easy adjustable arm

| Code | Finish | Price (In Rs) Per Pc |
|------|--------|-------------------------|
| 7435 | SS | 6999.00 |

**DC 50**

50kg with adjustable Arm
EN Standard : EN3#
Door width (mm): 1000
Door weight (kg): 50
Durability test : 5,00,000 cycles
Arm: Easy adjustable arm

| Code | Finish | Price (In Rs) Per Pc |
|-------|--------|-------------------------|
| 15421 | ATQ | 2199.00 |

**DC 70**

70kg with adjustable Arm
EN Standard : EN4#
Door width (mm): 1100
Door weight (kg): 70
Durability test : 5,00,000 cycles
Arm: Easy adjustable arm

| Code | Finish | Price (In Rs) Per Pc |
|-------|--------|-------------------------|
| 15422 | ATQ | 2399.00 |

**DC 80/P**

80kg with Palmet Arm
EN Standard : EN2#
Door width (mm): 1100
Door weight (kg): 80
Durability test : 5,00,000 cycles
Arm: Palmet arm

| Code | Finish | Price (In Rs) Per Pc |
|------|--------|-------------------------|
| 5908 | Silver | 2999.00 |

**DC 80/P**

80kg with Adjustable Arm
EN Standard : EN4#
Door width (mm): 1100
Door weight (kg): 80
Durability test : 5,00,000 cycles
Arm: Easy adjustable arm

| Code | Finish | Price (In Rs) Per Pc |
|------|--------|-------------------------|
| 5906 | SS | 4289.00 |

**DC 100/P**

100kg with Palmet Arm
EN Standard : EN2#
Door width (mm): 1100
Door weight (kg): 100
Durability test : 5,00,000 cycles
Arm: Palmet arm

| Code | Finish | Price (In Rs) Per Pc |
|-------|--------|-------------------------|
| 15423 | ATQ | 4949.00 |

**CDC 85**

85kg Concealed Door Closer
upto 40mm
EN Standard : EN2#
Door width (mm): 950
Door weight (kg): 60
Durability test : 5,00,000 cycles
Arm: Palmet arm

| Code | Finish | Price (In Rs) Per Pc |
|------|--------|-------------------------|
| 5928 | SS | 5199.00 |

**CDC 80
(Slim)**

| Code | Price (In Rs) Per Pc |
|------|-------------------------|
| 9059 | 5499.00 |

80kg Concealed Door Closer
upto 40mm EN Standard : EN2#
Door width (mm): 950 Door weight (kg): 60
Durability test : 5,00,000 cycles Arm: Palmet arm



Lord Series
Door Handle

DOOR ARCHITECTURAL HARDWARE

LORD SERIES



ADY

| Code | FINISH | Price (In Rs) Per Pair |
|------|-----------|---------------------------|
| 2631 | FSS | 4559 |
| 2625 | MAB | 4559 |
| 2603 | MSN | 4559 |
| 2610 | MTS | 4559 |
| 2627 | ROSE GOLD | 4559 |



BEK

| Code | FINISH | Price (In Rs) Per Pair |
|------|-------------|---------------------------|
| 2732 | BLACK/WHITE | 4879 |
| 2741 | CPS | 4559 |
| 2733 | MAB/WOOD | 5299 |
| 2729 | MSN/WOOD | 5299 |
| 2726 | MTS/MSN | 4559 |



ALY

| Code | FINISH | Price (In Rs) Per Pair |
|------|-----------|---------------------------|
| 2665 | FSS | 4559 |
| 2663 | MAB | 4559 |
| 2658 | MSN | 4559 |
| 2659 | MTS | 4559 |
| 2673 | PVD | 5619 |
| 2664 | ROSE GOLD | 5619 |



EMO

| Code | FINISH | Price (In Rs) Per Pair |
|------|-----------|---------------------------|
| 2655 | FSS | 4559 |
| 2642 | MAB | 4559 |
| 2637 | MSN | 4559 |
| 2641 | MTS | 4559 |
| 2646 | ROSE GOLD | 5619 |



BAO

| Code | FINISH | Price (In Rs) Per Pair |
|------|----------|---------------------------|
| 2706 | CPS | 4239 |
| 2708 | MSN/MTS | 4239 |
| 2712 | MSN/WOOD | 4239 |



NOA

| Code | FINISH | Price (In Rs) Per Pair |
|------|----------|---------------------------|
| 2689 | CPS | 4239 |
| 2696 | MSN/WOOD | 4239 |
| 2691 | MTS/MSN | 4239 |



OAK

| Code | FINISH | Price (In Rs) Per Pair |
|------|----------|---------------------------|
| 2675 | CPS | 4769 |
| 2679 | MAB | 4769 |
| 2678 | MSN/MTS | 5089 |
| 2677 | MSN/WOOD | 7099 |



SOL

| Code | FINISH | Price (In Rs) Per Pair |
|------|----------|---------------------------|
| 2698 | CPS | 4239 |
| 2703 | MSN/WOOD | 4239 |
| 2700 | MTS/MSN | 4239 |



OZA

| Code | FINISH | Price (In Rs) Per Pair |
|------|----------|---------------------------|
| 2717 | CPS | 4239 |
| 2714 | MSN/WOOD | 4559 |
| 2719 | MTS/MSN | 4559 |



RIO

| Code | FINISH | Price (In Rs) Per Pair |
|------|-----------|---------------------------|
| 2751 | FSS | 4559 |
| 2746 | MAB | 4559 |
| 2744 | MSN | 4559 |
| 2747 | MTS | 4559 |
| 2750 | ROSE GOLD | 5619 |

LUXOS SERIES



Inner Pack & Master Pack - 1 & 10

DARCY



On Rose With Escutcheons

| Code | Finish | Price (In Rs) Per Pair |
|------|--------|---------------------------|
| 4050 | SS | 4599.00 |
| 3519 | MSN | 4599.00 |
| 4590 | CP | 4599.00 |
| 6545 | ATQ | 4599.00 |

ELLESSE



On Rose With Escutcheons

| Code | Finish | Price (In Rs) Per Pair |
|------|--------|---------------------------|
| 8522 | SS | 3799.00 |
| 1890 | ATQ | 3799.00 |

ETHEN



On Rose With Escutcheons

| Code | Finish | Price (In Rs) Per Pair |
|------|--------|---------------------------|
| 3741 | NSY | 4999.00 |
| 4287 | CPS | 4999.00 |
| 8953 | NSB | 4999.00 |

MACH



On CY

| Code | Finish | Price (In Rs) Per Pair |
|------|--------|---------------------------|
| 6040 | CPW | 3899.00 |
| 4697 | CPY | 3899.00 |
| 5354 | CPB | 3859.00 |
| 8914 | CPS | 3859.00 |

OLLY



On CY

| Code | Finish | Price (In Rs) Per Pair |
|------|--------|---------------------------|
| 6876 | SS | 3899.00 |
| 6369 | ATQ | 3899.00 |
| 3945 | CP | 3899.00 |

PRIUS



On Rose With Escutcheons

| Code | Finish | Price (In Rs) Per Pair |
|------|--------|---------------------------|
| 8775 | CPS | 3399.00 |
| 4081 | CPW | 3399.00 |
| 5545 | SSB | 3399.00 |

TWINS



On Rose With Escutcheons

| Code | Finish | Price (In Rs) Per Pair |
|------|--------|---------------------------|
| 4042 | FSS | 7999.00 |

RYNE

On Rose With Escutcheons

| Code | Finish | Price (In Rs) Per Pair |
|------|--------|---------------------------|
| 1961 | CPY | 4899.00 |
| 8392 | CPB | 4899.00 |
| 5658 | CPS | 4899.00 |

SWAROVSKI

Inner Pack & Master Pack - 1 / 6

| AURO | | Item Description | UOM | PVD | CL | FSS | CP |
|--|--------------------------|------------------|-------|-------------|-------------|-------------|-------------|
|  | 10"CY | | Code | 7364 | 8557 | 6976 | 7351 |
| | | Per Pair | Price | 9019 | 8469 | 8359 | 8469 |
| | On Rose With Escutcheons | | Code | 7124 | 7285 | 6220 | 7264 |
| | | Per Pair | Price | 9019 | 8469 | 8359 | 8469 |
| MARCO | | Item Description | UOM | PVD | CL | FSS | CP |
|  | 10"CY | | Code | 8131 | 8208 | 9084 | 6078 |
| | | Per Pair | Price | 9019 | 8469 | 8359 | 8469 |
| | On Rose With Escutcheons | | Code | 6274 | 7260 | 7531 | 6509 |
| | | Per Pair | Price | 9019 | 8469 | 8359 | 8469 |
| PICO | | Item Description | UOM | PVD | CL | FSS | CP |
|  | 10"CY | | Code | 7086 | 7690 | 3565 | 6032 |
| | | Per Pair | Price | 6929 | 6379 | 6269 | 6379 |
| | On Rose With Escutcheons | | Code | 5876 | 3698 | 5867 | 4318 |
| | | Per Pair | Price | 6929 | 6379 | 6269 | 6379 |



CRYSTA

On Rose With Escutcheons



| Code | Finish | Price (In Rs) Per Pair |
|------|--------|------------------------|
| 7945 | MSS | 19799.00 |
| 5438 | CP | 21999.00 |
| 3688 | GP | 24199.00 |

SWAROVSKI

Inner Pack & Master Pack - 1 / 12

ATARA 25



On Rose With Escutcheons

| Code | Finish | Price (In Rs) Per Pair |
|------|--------|---------------------------|
| 3397 | FSS | 5059.00 |
| 3399 | CP | 5499.00 |

SIRO



On Rose With Escutcheons

| Code | Finish | Price (In Rs) Per Pair |
|------|--------|---------------------------|
| 5744 | FSS | 7509.00 |
| 5779 | CP | 7919.00 |

ZELDA



On Rose With Escutcheons

| Code | Finish | Price (In Rs) Per Pair |
|------|--------|---------------------------|
| 5627 | FSS | 6929.00 |
| 7426 | CP | 8029.00 |

ALINA



On Rose With Escutcheons

| Code | Finish | Price (In Rs) Per Pair |
|------|--------|---------------------------|
| 8665 | PVD | 8579.00 |
| 7109 | CL | 8029.00 |
| 8539 | FSS | 7919.00 |
| 5723 | CP | 8029.00 |

CASA



On Rose With Escutcheons

| Code | Finish | Price (In Rs) Per Pc |
|------|--------|-------------------------|
| 3401 | FSS | 17049.00 |
| 3402 | ATQ | 17049.00 |
| 3403 | GP | 17049.00 |

SUVA



On Rose With Escutcheons

| Code | Finish | Price (In Rs) Per Pc |
|------|--------|-------------------------|
| 3404 | FSS | 7479.00 |
| 3405 | ATQ | 7479.00 |
| 3406 | GP | 8139.00 |

PUMA



Swarovski Knob

| Code | Finish | Price (In Rs) Per Pc |
|------|--------|-------------------------|
| 4897 | FSS | 5829.00 |
| 3442 | CP | 6269.00 |
| 8045 | GP | 6489.00 |
| 8680 | FSS | 12979.00 |
| 8280 | CP | 13529.00 |
| 5301 | GP | 13859.00 |

EMMA



Swarovski Knob

| Code | Finish | Price (In Rs) Per Pc |
|------|--------|-------------------------|
| 4044 | FSS | 949.00 |
| 6493 | CP | 1099.00 |
| 3813 | GP | 1149.00 |
| 6414 | FSS | 1539.00 |
| 5443 | CP | 1779.00 |
| 7216 | GP | 1869.00 |
| 7302 | FSS | 3299.00 |
| 8102 | CP | 3409.00 |
| 6752 | GP | 3519.00 |
| 6359 | FSS | 7699.00 |
| 3935 | CP | 7809.00 |
| 8397 | GP | 7919.00 |

PREMIUM HANDLE BRASS

Price (Per Pair)

SADIYA

10" CY Mortise Handle
On Rose Mortise Handle



| | FSS | ATQ |
|-------|-------------|-------------|
| Code | 4430 | 5749 |
| Price | 4369 | 4369 |
| Code | 5147 | 7576 |
| Price | 4369 | 4369 |

FLO

10" CY Mortise Handle
On Rose Mortise Handle



| | FSS | ATQ |
|-------|-------------|-------------|
| Code | 7457 | 1737 |
| Price | 4839 | 4839 |
| Code | 3321 | 5024 |
| Price | 4839 | 4839 |

DEA

10" CY Mortise Handle
On Rose Mortise Handle



| | FSS | ATQ |
|-------|-------------|-------------|
| Code | 3821 | 8906 |
| Price | 4549 | 4549 |
| Code | 3365 | 3839 |
| Price | 4549 | 4549 |

ISY

10" CY Mortise Handle
On Rose Mortise Handle



| | FSS | ATQ |
|-------|-------------|-------------|
| Code | 5682 | 3503 |
| Price | 4369 | 4369 |
| Code | 5551 | 5281 |
| Price | 4369 | 4369 |

SKYLA

10" CY Mortise Handle
On Rose Mortise Handle



| | FSS | ATQ |
|-------|-------------|-------------|
| Code | 5604 | 3491 |
| Price | 4719 | 4719 |
| Code | 1821 | 3664 |
| Price | 4719 | 4719 |

SILVANA

10" CY Mortise Handle
On Rose Mortise Handle



| | FSS | ATQ |
|-------|-------------|-------------|
| Code | 4282 | 7962 |
| Price | 4549 | 4549 |
| Code | 7848 | 7182 |
| Price | 4549 | 4549 |

ANGELA

10" CY Mortise Handle
On Rose Mortise Handle



| | FSS | ATQ |
|-------|-------------|-------------|
| Code | 10084 | 11072 |
| Price | 4369 | 4369 |
| Code | 1829 | 1830 |
| Price | 4369 | 4369 |

SYLVIA

10" CY Mortise Handle
On Rose Mortise Handle



| | FSS | ATQ |
|-------|-------------|-------------|
| Code | 6068 | 5201 |
| Price | 4139 | 4139 |
| Code | 1022 | 6786 |
| Price | 4139 | 4139 |

VELMA

10" CY Mortise Handle
On Rose Mortise Handle



| | FSS | ATQ |
|-------|-------------|-------------|
| Code | 5847 | 8286 |
| Price | 4139 | 4139 |
| Code | 3581 | 7261 |
| Price | 4139 | 4139 |

ELKO

10" CY Mortise Handle
On Rose Mortise Handle



| | FSS | ATQ |
|-------|-------------|-------------|
| Code | 3913 | 8913 |
| Price | 4139 | 4139 |
| Code | 5179 | 7958 |
| Price | 4139 | 4139 |

MARTINA

10" CY Mortise Handle
On Rose Mortise Handle

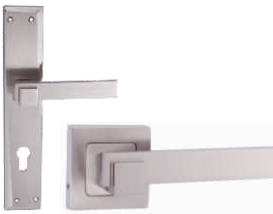

| | SS TWO TONE | ATQ |
|-------|----------------|-------------|
| Code | 8595 | 5246 |
| Price | 4369 | 4369 |
| Code | 6783 | 4467 |
| Price | 4369 | 4369 |

OPASA

10" CY Mortise Handle
On Rose Mortise Handle



| | SS TWO TONE | ATQ |
|-------|----------------|-------------|
| Code | 4761 | 4039 |
| Price | 4249 | 4249 |
| Code | 8517 | 4731 |
| Price | 4249 | 4249 |

EDINA



10" CY Mortise Handle
On Rose Mortise Handle

| | SS TWO TONE | ATQ |
|-------|----------------|-------------|
| Code | 6496 | 5278 |
| Price | 3969 | 3969 |
| Code | 5977 | 1336 |
| Price | 3969 | 3969 |

SS304 SOLID / TUBE MORTISE HANDLE

Inner Pack & Master Pack - 1 / 20

CAMILLA



On Rose With Escutcheons

| Code | Finish | Price (In Rs) Per Set |
|------|--------|--------------------------|
| 5956 | FSS | 3499.00 |

SS01



On Rose With Escutcheons

| Code | Finish | Price (In Rs) Per Pair |
|------|--------|---------------------------|
| 9066 | SS | 1479.00 |

SS02



On Rose With Escutcheons

| Code | Finish | Price (In Rs) Per Pair |
|-------|--------|---------------------------|
| 10935 | SS | 1479.00 |

SS04



On Rose With Escutcheons

| Code | Finish | Price (In Rs) Per Pair |
|------|--------|---------------------------|
| 7901 | SS | 1599.00 |

ESCUTCHEONS

55 mm ZINC



CY Square Zinc

| Code | Finish | Price (In Rs) Per Pc |
|------|--------|-------------------------|
| 2387 | FSS | 339.00 |
| 2391 | ATQ | 339.00 |
| 2393 | MSS | 339.00 |
| 2395 | MAB | 339.00 |

55 mm ZINC



CY Round Zinc

| Code | Finish | Price (In Rs) Per Pc |
|------|--------|-------------------------|
| 2390 | FSS | 339.00 |
| 2396 | ATQ | 339.00 |
| 2398 | MSS | 339.00 |
| 2399 | MAB | 339.00 |

50 mm ZINC



CY Square Zinc

| Code | Finish | Price (In Rs) Per Pc |
|------|--------|-------------------------|
| 2400 | FSS | 279.00 |
| 2401 | ATQ | 279.00 |
| 2402 | MSS | 279.00 |
| 2403 | MAB | 279.00 |

55 mm BRASS



CY Square Brass

| Code | Finish | Price (In Rs) Per Pc |
|------|--------|-------------------------|
| 2405 | FSS | 499.00 |
| 2406 | ATQ | 499.00 |
| 2407 | MSS | 499.00 |
| 2410 | MAB | 499.00 |

50 mm BRASS



CY Square Brass

| Code | Finish | Price (In Rs) Per Pc |
|------|--------|-------------------------|
| 2411 | FSS | 499.00 |
| 2412 | ATQ | 499.00 |
| 2413 | MSS | 499.00 |
| 2414 | MAB | 499.00 |

50 mm SS



CY Square Brass

| Code | Finish | Price (In Rs) Per Pc |
|------|--------|-------------------------|
| 2415 | FSS | 99.00 |
| 2416 | ATQ | 99.00 |
| 2417 | MSS | 99.00 |
| 2420 | MAB | 99.00 |



55mm ZINC Curve CY Curve Zinc

| Code | Finish | Price (In Rs) Per Pc |
|------|--------|-------------------------|
| 2427 | FSS | 339.00 |
| 2428 | ATQ | 339.00 |
| 2431 | MSS | 339.00 |
| 2432 | MAB | 339.00 |





EDO
DoorHandle

MODERNA Series
Door Handles

DOOR ARCHITECTURAL HARDWARE

MODERNA SERIES

| SMOKE | 8" CYS | | UOM | SS | MSS | MAB | MTS | ROSE GOLD | |
|--|----------------------------------|----------|---------|-------|-------|-------|-----------|-----------|-------|
| | | | | Code | 16920 | 16777 | 16778 | 16781 | 16783 |
|  | 60 mm S2 - Both Side Key | | Per Set | Price | 3559 | 3559 | 3619 | 3959 | 4359 |
| | | | | Code | 16922 | 16702 | 16703 | 16704 | 16706 |
| | 60 mm S1 - One Side Key and Knob | | Per Set | Price | 3559 | 3559 | 3619 | 3959 | 4359 |
| | | | | Code | 16921 | 16779 | 16780 | 16784 | 16786 |
| 60 mm S4 - Coin and Knob | | Per Set | Price | 3559 | 3559 | 3619 | 3959 | 4359 | |
| ON ROSE | | UOM | SS | MSS | MAB | MTS | ROSE GOLD | | |
| | | | Code | 16923 | 16551 | 16552 | 16553 | 16555 | |
| | | Per Pair | Price | 2769 | 2769 | 2829 | 2899 | 3359 | |

| CHILLI | 8" CYS | | UOM | FSS | MSS | MAB | MTS | ROSE GOLD | |
|---|----------------------------------|----------|---------|-------|-------|-------|-----------|-----------|-------|
| | | | | Code | 16973 | 16792 | 16793 | 16794 | 16796 |
|  | 60 mm S2 - Both Side Key | | Per Set | Price | 3459 | 3459 | 3519 | 3799 | 4199 |
| | | | | Code | 16974 | 16707 | 16708 | 16709 | 16710 |
| | 60 mm S1 - One Side Key and Knob | | Per Set | Price | 3459 | 3459 | 3519 | 3799 | 4199 |
| | | | | Code | 16975 | 16787 | 16788 | 16789 | 16791 |
| 60 mm S4 - Coin and Knob | | Per Set | Price | 3459 | 3459 | 3519 | 3799 | 4199 | |
| ON ROSE | | UOM | FSS | MSS | MAB | MTS | ROSE GOLD | | |
| | | | Code | 16976 | 16556 | 16557 | 16558 | 16560 | |
| | | Per Pair | Price | 2529 | 2529 | 2589 | 2699 | 3199 | |

| TIFFY | 8" CYS | | UOM | CPS | MAB | MTS | ROSE GOLD | |
|--|----------------------------------|----------|---------|-------|---------------|-------|-----------|-------|
| | | | | Code | 16797 | 16798 | 16799 | 16801 |
|  | 60 mm S2 - Both Side Key | | Per Set | Price | 3449 | 3509 | 3899 | 4199 |
| | | | | Code | 16711 | 16712 | 16713 | 16714 |
| | 60 mm S1 - One Side Key and Knob | | Per Set | Price | 3449 | 3509 | 3899 | 4199 |
| | | | | Code | 16802 | 16803 | 16804 | 16806 |
| 60 mm S4 - Coin and Knob | | Per Set | Price | 3449 | 3509 | 3899 | 4199 | |
| ON ROSE | | UOM | MSS | MAB | MTS/ROSE GOLD | | | |
| | | | Code | 16561 | 16562 | 16565 | | |
| | | Per Pair | Price | 2419 | 2479 | 3279 | | |

| RHINO | 8" CYS | | UOM | MSS | MAB | |
|--|----------------------------------|----------|---------|-------|-------|-------|
| | | | | Code | 16964 | 16965 |
|  | 60 mm S2 - Both Side Key | | Per Set | Price | 3449 | 3509 |
| | | | | Code | 16966 | 16967 |
| | 60 mm S1 - One Side Key and Knob | | Per Set | Price | 3449 | 3509 |
| | | | | Code | 16968 | 16969 |
| 60 mm S4 - Coin and Knob | | Per Set | Price | 3449 | 3509 | |
| ON ROSE | | UOM | MSS | MAB | | |
| | | | Code | 16432 | 16137 | |
| | | Per Pair | Price | 2419 | 2479 | |

MODRENA SERIES

| SANGRIA | | 8" CYS | | UOM | MSS | MAB | MTS | ROSE GOLD |
|--|----------------------------------|----------|-------|------|------|-------|-----------|-----------|
|  | | | Code | | 7002 | 8263 | 16879 | 16881 |
| | 60 mm S2 - Both Side Key | Per Set | Price | | 3449 | 3509 | 3849 | 4199 |
| | | | Code | | 5917 | 6618 | 16715 | 16717 |
| | 60 mm S1 - One Side Key and Knob | Per Set | Price | | 3449 | 3509 | 3849 | 4199 |
| | | | Code | | 2844 | 2846 | 16882 | 16884 |
| | 60 mm S4 - Coin and Knob | Per Set | Price | | 3449 | 3509 | 3849 | 4199 |
| | 10" CY | | UOM | MSS | MAB | MTS | ROSE GOLD | |
| | | | Code | 1997 | 2000 | 16593 | 16595 | |
| | | Per Pair | Price | 2419 | 2479 | 2819 | 3279 | |
| | ON ROSE | | UOM | MSS | MAB | MTS | ROSE GOLD | |
| | | | Code | 5298 | 6284 | 16587 | 16589 | |
| | | Per Pair | Price | 2419 | 2479 | 2819 | 3279 | |

| SCARLET | | 8" CYS | | UOM | MSS | MAB | MTS | ROSE GOLD |
|---|----------------------------------|----------|-------|------|------|-------|-----------|-----------|
|  | | | Code | | 4845 | 4800 | 16885 | 16887 |
| | 60 mm S2 - Both Side Key | Per Set | Price | | 3559 | 3619 | 3959 | 4309 |
| | | | Code | | 3929 | 5537 | 16718 | 16720 |
| | 60 mm S1 - One Side Key and Knob | Per Set | Price | | 3559 | 3619 | 3959 | 4309 |
| | | | Code | | 2911 | 2913 | 16888 | 16890 |
| | 60 mm S4 - Coin and Knob | Per Set | Price | | 3559 | 3619 | 3959 | 4309 |
| | 10" CY | | UOM | MSS | MAB | MTS | ROSE GOLD | |
| | | | Code | 2019 | 2022 | 16596 | 16598 | |
| | | Per Pair | Price | 2769 | 2829 | 2899 | 2359 | |
| | ON ROSE | | UOM | MSS | MAB | MTS | ROSE GOLD | |
| | | | Code | 5993 | 5613 | 16584 | 16586 | |
| | | Per Pair | Price | 2769 | 2829 | 2899 | 2359 | |

| BONE | | 8" CYS | | UOM | MSS | MAB | MTS | ROSE GOLD |
|--|----------------------------------|----------|-------|-------|-------|-------|-----------|-----------|
|  | | | Code | | 13565 | 13567 | 16891 | 16892 |
| | 60 mm S2 - Both Side Key | Per Set | Price | | 3859 | 3919 | 4259 | 4609 |
| | | | Code | | 13569 | 13571 | 16721 | 16722 |
| | 60 mm S1 - One Side Key and Knob | Per Set | Price | | 3859 | 3919 | 4259 | 4609 |
| | | | Code | | 13573 | 13575 | 16893 | 16894 |
| | 60 mm S4 - Coin and Knob | Per Set | Price | | 3859 | 3919 | 4259 | 4609 |
| | ON ROSE | | UOM | MSS | MAB | MTS | ROSE GOLD | |
| | | | Code | 13553 | 13555 | 16582 | 16583 | |
| | | Per Pair | Price | 2769 | 2829 | 2899 | 3359 | |

MODRENA SERIES

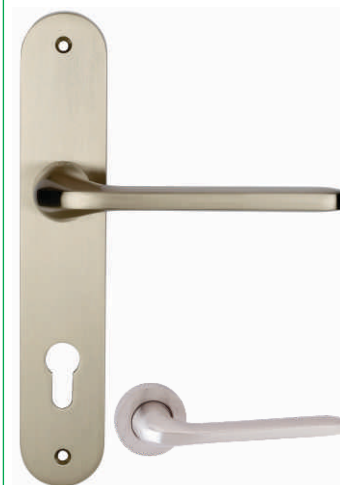
| OLIVE | 8" CYS | | UOM | FSS | ATQ | MSS | MAB | MTS | ROSE GOLD |
|--------------|--|----------|-------|------|------|------|------|-----------|-----------|
| |  | | | Code | 4468 | 5896 | 6164 | 4460 | 16859 |
| | 60 mm S2 - Both Side Key | Per Set | Price | 3449 | 3509 | 3449 | 3509 | 3849 | 4199 |
| | | | Code | 3808 | 4976 | 4924 | 5883 | 16723 | 16725 |
| | 60 mm S1 - One Side Key and Knob | Per Set | Price | 3449 | 3509 | 3449 | 3509 | 3849 | 4199 |
| | | | Code | 2896 | 2898 | 2897 | 2899 | 16862 | 16864 |
| | 60 mm S4 - Coin and Knob | Per Set | Price | 3449 | 3509 | 3449 | 3509 | 3849 | 4199 |
| 10" CY | | UOM | FSS | ATQ | MSS | MAB | MTS | ROSE GOLD | |
| | | | Code | 2007 | 2009 | 2008 | 2010 | 16599 | 16601 |
| | | Per Pair | Price | 2419 | 2479 | 2419 | 2479 | 2819 | 3279 |
| ON ROSE | | UOM | FSS | ATQ | MSS | MAB | MTS | ROSE GOLD | |
| | | | Code | 7717 | 7088 | 7811 | 4018 | 16579 | 16581 |
| | | Per Pair | Price | 2419 | 2479 | 2419 | 2479 | 2819 | 3279 |

| TOMATO | 8" CYS | | UOM | FSS | MSS | MAB | | |
|---------------|--|----------|-------|------|------|------|-----------|-------|
| |  | | | Code | 5055 | 6329 | 4366 | |
| | 60 mm S2 - Both Side Key | Per Set | Price | 3559 | 3559 | 3619 | | |
| | | | Code | 3880 | 4205 | 7310 | | |
| | 60 mm S1 - One Side Key and Knob | Per Set | Price | 3559 | 3559 | 3619 | | |
| | | | Code | 2923 | 2924 | 2927 | | |
| | 60 mm S4 - Coin and Knob | Per Set | Price | 3559 | 3559 | 3619 | | |
| 10" CY | | UOM | FSS | MSS | MAB | | | |
| | | | Code | 2024 | 2026 | 2029 | | |
| | | Per Pair | Price | 2769 | 2769 | 2829 | | |
| ON ROSE | | UOM | FSS | MSS | MAB | MTS | ROSE GOLD | |
| | | | Code | 8158 | 8752 | 8300 | 16577 | 16578 |
| | | Per Pair | Price | 2769 | 2769 | 2829 | 2899 | 3359 |

| FLAX | 8" CYS | | UOM | MSS | MAB | | |
|-------------|--|----------|-------|------|------|-----------|-------|
| |  | | | Code | 2170 | 2176 | |
| | 60 mm S2 - Both Side Key | Per Set | Price | 3449 | 3509 | | |
| | | | Code | 2178 | 2185 | | |
| | 60 mm S1 - One Side Key and Knob | Per Set | Price | 3449 | 3509 | | |
| | | | Code | 2830 | 2832 | | |
| | 60 mm S4 - Coin and Knob | Per Set | Price | 3449 | 3509 | | |
| 10" CY | | UOM | MSS | MAB | | | |
| | | | Code | 1992 | 1994 | | |
| | | Per Pair | Price | 2419 | 2479 | | |
| ON ROSE | | UOM | MSS | MAB | MTS | ROSE GOLD | |
| | | | Code | 5198 | 4782 | 16571 | 16572 |
| | | Per Pair | Price | 2419 | 2479 | 2819 | 3279 |







MODERNA SERIES

| RUSSET | 8" CYS | | UOM | MSS | | MAB | |
|---------|--|----------|-------|------|------|-----------|-------|
| |  | | | Code | 5461 | | |
| | 60 mm S2 - Both Side Key | Per Set | Price | 3559 | | | 3619 |
| | | | Code | 8247 | | | 3866 |
| | 60 mm S1 - One Side Key and Knob | Per Set | Price | 3559 | | | 3619 |
| | | | Code | 3066 | | | 3073 |
| | 60 mm S4 - Coin and Knob | Per Set | Price | 3559 | | | 3619 |
| 10" CY | | UOM | MSS | | MAB | | |
| | | | Code | 2047 | | | 2051 |
| | | Per Pair | Price | 2769 | | | 2829 |
| ON ROSE | | UOM | MSS | MAB | MTS | ROSE GOLD | |
| | | | Code | 6641 | 3748 | 16573 | 16574 |
| | | Per Pair | Price | 2769 | 2829 | 2899 | 3359 |

| PLUM | 8" CYS | | UOM | CPS | | MAB | |
|---------|--|----------|-------|-------|---------------|-----|-------|
| |  | | | Code | 13501 | | |
| | 60 mm S2 - Both Side Key | Per Set | Price | 3559 | | | 3619 |
| | | | Code | 13433 | | | 13648 |
| | 60 mm S1 - One Side Key and Knob | Per Set | Price | 3559 | | | 3619 |
| | | | Code | 13649 | | | 13650 |
| | 60 mm S4 - Coin and Knob | Per Set | Price | 3559 | | | 3619 |
| 10" CY | | UOM | CPS | | MAB | | |
| | | | Code | 14351 | | | 14352 |
| | | Per Pair | Price | 2769 | | | 2829 |
| ON ROSE | | UOM | CPS | MAB | MTS/ROSE GOLD | | |
| | | | Code | 13400 | 13444 | | 16570 |
| | | Per Pair | Price | 2769 | 2829 | | 3359 |

| CYAN | 8" CYS | | UOM | FSS | ATQ | MSS | MAB | | |
|---------|--|----------|-------|------|------|------|------|-----------|-------|
| |  | | | Code | 8921 | 6919 | 3464 | | 3597 |
| | 60 mm S2 - Both Side Key | Per Set | Price | 3479 | 3539 | 3479 | | 3539 | |
| | | | Code | 4531 | 8312 | 7647 | | 6256 | |
| | 60 mm S1 - One Side Key and Knob | Per Set | Price | 3479 | 3539 | 3479 | | 3539 | |
| | | | Code | 2941 | 2943 | 2942 | | 2944 | |
| | 60 mm S4 - Coin and Knob | Per Set | Price | 3479 | 3539 | 3479 | | 3539 | |
| 10" CY | | UOM | FSS | ATQ | MSS | MAB | | | |
| | | | Code | 2030 | 2032 | 2031 | | 2035 | |
| | | Per Pair | Price | 2449 | 2509 | 2449 | | 2509 | |
| ON ROSE | | UOM | FSS | ATQ | MSS | MAB | MTS | ROSE GOLD | |
| | | | Code | 8491 | 7158 | 6574 | 8926 | 16566 | 16567 |
| | | Per Pair | Price | 2449 | 2509 | 2449 | 2509 | 2849 | 3309 |

MODERNA SERIES

| CAPRI | | 8" CYS | UOM | MSS | | MAB | | |
|--|----------------------------------|-------------|-------|-------|-------|-------|-----------|-----------|
|  | | | | Code | 13619 | 13614 | | |
| | 60 mm S2 - Both Side Key | Per Set | Price | 3559 | | 3619 | | |
| | | | | Code | 13616 | 13618 | | |
| | 60 mm S1 - One Side Key and Knob | Per Set | Price | 3559 | | 3619 | | |
| | | | | Code | 13620 | 13622 | | |
| | 60 mm S4 - Coin and Knob | Per Set | Price | 3559 | | 3619 | | |
| | | ON ROSE | UOM | MSS | MAB | MTS | ROSE GOLD | |
| | On Rose With Escutcheons | | Code | 13557 | 13559 | 16575 | 16576 | |
| | | Per Pair | Price | 2769 | 2829 | 2899 | 3359 | |
| EDO | | ON CY | UOM | FSS | ATQ | MTS | ROSE GOLD | |
|  | ON PLATE | Per Pair | Code | 15945 | 15946 | 16654 | 16655 | |
| | | | Price | 2499 | 2569 | 2699 | 3099 | |
| LAWRENCE | | ON ROSE | UOM | MAB | MSS | | | |
|  | On Rose With Escutcheons | Per Pair | Code | 5356 | 4708 | | | |
| | | | Price | 4439 | 4369 | | | |
| XINITH | | ON ROSE | UOM | CPS | MAB | | | |
|  | On Rose With Escutcheons | Per Pair | Code | 4435 | 8266 | | | |
| | | | Price | 4799 | 4869 | | | |
| CEIL | | ON ROSE | UOM | MSS | MAB | MTS | ROSE GOLD | |
|  | On Rose With Escutcheons | Per Pair | Code | 13547 | 13546 | 16590 | 16592 | |
| | | | Price | 2999 | 3069 | 3199 | 3399 | |
| CEIL | | PULL HANDLE | UOM | FSS | MSS | MAB | MTS | ROSE GOLD |
|  | Pull Handles 10" | Per Pc | Code | 14049 | 14051 | 14050 | 16809 | 16810 |
| | | | Price | 2549 | 2649 | 3319 | 2699 | 2699 |
| BUD | | ON ROSE | UOM | MSS | MAB | | | |
|  | On Rose With Escutcheons | Per Pair | Code | 4027 | 8044 | | | |
| | | | Price | 3939 | 3999 | | | |



IRIS Series

Door Handles

DOOR ARCHITECTURAL HARDWARE



**IRIS MORTISE HANDLE****TEAL**

| 8" CYS | UOM | | CPS | MAB |
|----------------------------------|---------|-------|-------|-------|
| | | Code | 16731 | 16924 |
| 60 mm S2 - Both Side Key | Per Set | Price | 2559 | 2619 |
| | | Code | 16730 | 16925 |
| 60 mm S1 - One Side Key and Knob | Per Set | Price | 2599 | 2659 |
| | | Code | 16732 | 16926 |
| 60 mm S4 - Coin and Knob | Per Set | Price | 2559 | 2619 |
| | | Code | 16733 | 16927 |
| KY 8" Lever Cut Lock | Per Set | Price | 1549 | 1639 |
| | | Code | 16734 | 16928 |
| PKY Bathroom Lock | Per Set | Price | 1539 | 1629 |

| 10" CY | UOM | | CPS | MAB |
|----------------------------------|---------|-------|-------|-------|
| | | Code | 16728 | 16929 |
| 60 mm S2 - Both Side Key | Per Set | Price | 3019 | 3089 |
| | | Code | 16726 | 16930 |
| 60 mm S1 - One Side Key and Knob | Per Set | Price | 3059 | 3129 |
| | | Code | 16729 | 16931 |
| 60 mm S4 - Coin and Knob | Per Set | Price | 3019 | 2089 |

| ON ROSE | UOM | | CPS | MAB |
|--|----------|-------|-------|-------|
| | | Code | 16736 | 16932 |
| 60 mm S2 - Both Side Key | Per Set | Price | 3129 | 3199 |
| | | Code | 16735 | 16933 |
| 60 mm S1 - One Side Key and Knob | Per Set | Price | 3169 | 3239 |
| | | Code | 16737 | 16934 |
| 60 mm S4 - Coin and Knob | Per Set | Price | 3129 | 3199 |
| | | Code | 16807 | 16935 |
| OR (Only Rose) With Escutcheons | Per Pair | Price | 2099 | 2189 |

NAVY

| 8" CYS | UOM | | FSS | MAB |
|----------------------------------|---------|-------|-------|-------|
| | | Code | 16755 | 16950 |
| 60 mm S2 - Both Side Key | Per Set | Price | 2559 | 2619 |
| | | Code | 16754 | 16951 |
| 60 mm S1 - One Side Key and Knob | Per Set | Price | 2599 | 2659 |
| | | Code | 16756 | 16952 |
| 60 mm S4 - Coin and Knob | Per Set | Price | 2559 | 2619 |
| | | Code | 16757 | 16953 |
| KY 8" Lever Cut Lock | Per Set | Price | 1549 | 1639 |
| | | Code | 16758 | 16954 |
| PKY Bathroom Lock | Per Set | Price | 1539 | 1629 |

| 10" CY | UOM | | FSS | MAB |
|----------------------------------|---------|-------|-------|-------|
| | | Code | 16752 | 16955 |
| 60 mm S2 - Both Side Key | Per Set | Price | 3019 | 3089 |
| | | Code | 16753 | 16956 |
| 60 mm S1 - One Side Key and Knob | Per Set | Price | 3059 | 3129 |
| | | Code | 16751 | 16957 |
| 60 mm S4 - Coin and Knob | Per Set | Price | 3019 | 3089 |

| ON ROSE | UOM | | FSS | MAB |
|--|----------|-------|-------|-------|
| | | Code | 16760 | 16958 |
| 60 mm S2 - Both Side Key | Per Set | Price | 3129 | 3199 |
| | | Code | 16759 | 16959 |
| 60 mm S1 - One Side Key and Knob | Per Set | Price | 3169 | 3239 |
| | | Code | 16761 | 16960 |
| 60 mm S4 - Coin and Knob | Per Set | Price | 3129 | 3199 |
| | | Code | 16808 | 16961 |
| OR (Only Rose) With Escutcheons | Per Pair | Price | 2099 | 2169 |

IRIS MORTISE HANDLE

| SHYNE | 8" CYS | | UOM | FSS | |
|-------|--|----------|-------|-------|-------|
| | | | | Code | 16767 |
| | 60 mm S2 - Both Side Key | Per Set | Price | 2559 | |
| | | | Code | 16766 | |
| | 60 mm S1 - One Side Key and Knob | Per Set | Price | 2599 | |
| | | | Code | 16768 | |
| | 60 mm S4 - Coin and Knob | Per Set | Price | 2559 | |
| | | | Code | 16769 | |
| | KY 8" Lever Cut Lock | Per Set | Price | 1549 | |
| | | | Code | 16770 | |
| | PKY Bathroom Lock | Per Set | Price | 1539 | |
| | | | | | |
| | 10" CY | | UOM | FSS | |
| | | | Code | 16764 | |
| | 60 mm S2 - Both Side Key | Per Set | Price | 3019 | |
| | | | Code | 16765 | |
| | 60 mm S1 - One Side Key and Knob | Per Set | Price | 3059 | |
| | | | Code | 16763 | |
| | 60 mm S4 - Coin and Knob | Per Set | Price | 3019 | |
| | | | | | |
| | ON ROSE | | UOM | FSS | |
| | | | Code | 16772 | |
| | 60 mm S2 - Both Side Key | Per Set | Price | 3129 | |
| | | | Code | 16771 | |
| | 60 mm S1 - One Side Key and Knob | Per Set | Price | 3169 | |
| | | | Code | 16773 | |
| | 60 mm S4 - Coin and Knob | Per Set | Price | 3129 | |
| | | | Code | 16775 | |
| | OR (Only Rose) With Escutcheons | Per Pair | Price | 2099 | |



| PERU | 8" CYS | | UOM | CPS | MAB |
|------|--|----------|-------|-------|-------|
| | | | | Code | 16743 |
| | 60 mm S2 - Both Side Key | Per Set | Price | 2909 | 2969 |
| | | | Code | 16742 | 16938 |
| | 60 mm S1 - One Side Key and Knob | Per Set | Price | 2949 | 3009 |
| | | | Code | 16744 | 16939 |
| | 60 mm S4 - Coin and Knob | Per Set | Price | 2909 | 2969 |
| | | | Code | 16745 | 16940 |
| | KY 8" Lever Cut Lock | Per Set | Price | 1649 | 1739 |
| | | | Code | 16746 | 16941 |
| | PKY Bathroom Lock | Per Set | Price | 1639 | 1729 |
| | | | | | |
| | 10" CY | | UOM | CPS | MAB |
| | | | Code | 16740 | 16942 |
| | 60 mm S2 - Both Side Key | Per Set | Price | 3459 | 3519 |
| | | | Code | 16741 | 16943 |
| | 60 mm S1 - One Side Key and Knob | Per Set | Price | 3499 | 3559 |
| | | | Code | 16739 | 16944 |
| | 60 mm S4 - Coin and Knob | Per Set | Price | 3459 | 3519 |
| | | | | | |
| | ON ROSE | | UOM | CPS | MAB |
| | | | Code | 16748 | 16945 |
| | 60 mm S2 - Both Side Key | Per Set | Price | 3559 | 3619 |
| | | | Code | 16747 | 16946 |
| | 60 mm S1 - One Side Key and Knob | Per Set | Price | 3599 | 3659 |
| | | | Code | 16749 | 16947 |
| | 60 mm S4 - Coin and Knob | Per Set | Price | 3559 | 3619 |
| | | | Code | 16776 | 16948 |
| | OR (Only Rose) With Escutcheons | Per Pair | Price | 2549 | 2609 |



**IRIS MORTISE HANDLE****FALU**

| 8" CYS | | UOM | CPS | MAB |
|--|----------|-------|-------------|-------------|
| | | Code | 15546 | 15644 |
| 60 mm S2 - Both Side Key | Per Set | Price | 2909 | 2969 |
| | | Code | 15547 | 15645 |
| 60 mm S1 - One Side Key and Knob | Per Set | Price | 2949 | 3009 |
| | | Code | 15548 | 15646 |
| 60 mm S4 - Coin and Knob | Per Set | Price | 2909 | 2969 |
| | | Code | 15549 | 15630 |
| KY 8" Lever Cut Lock | Per Set | Price | 1649 | 1739 |
| | | Code | 15550 | 15647 |
| PKY Bathroom Lock | Per Set | Price | 1639 | 1729 |
| | | | | |
| 10" CY | | UOM | CPS | MAB |
| | | Code | 15551 | 15656 |
| 60 mm S2 - Both Side Key | Per Set | Price | 3459 | 3519 |
| | | Code | 15552 | 15650 |
| 60 mm S1 - One Side Key and Knob | Per Set | Price | 3499 | 3554 |
| | | Code | 15553 | 15651 |
| 60 mm S4 - Coin and Knob | Per Set | Price | 3459 | 3519 |
| | | | | |
| ON ROSE | | UOM | CPS | MAB |
| | | Code | 15554 | 15653 |
| 60 mm S2 - Both Side Key | Per Set | Price | 3559 | 3619 |
| | | Code | 15555 | 15654 |
| 60 mm S1 - One Side Key and Knob | Per Set | Price | 3599 | 3659 |
| | | Code | 15556 | 15655 |
| 60 mm S4 - Coin and Knob | Per Set | Price | 3559 | 3619 |
| | | Code | 15557 | 15649 |
| OR (Only Rose) With Escutcheons | Per Pair | Price | 2549 | 2609 |
| | | Code | 15558 | 15657 |
| WR Without Escutcheons | Per Set | Price | 2299 | 2559 |

LACE

| 8" CYS | | UOM | CPS | MAB |
|--|----------|-------|-------------|-------------|
| | | Code | 15562 | 15659 |
| 60 mm S2 - Both Side Key | Per Set | Price | 2659 | 2719 |
| | | Code | 15563 | 15640 |
| 60 mm S1 - One Side Key and Knob | Per Set | Price | 2699 | 2751 |
| | | Code | 15564 | 15660 |
| 60 mm S4 - Coin and Knob | Per Set | Price | 2659 | 2719 |
| | | Code | 15565 | 15639 |
| KY 8" Lever Cut Lock | Per Set | Price | 1649 | 1739 |
| | | Code | 15566 | 15641 |
| PKY Bathroom Lock | Per Set | Price | 1639 | 1729 |
| | | | | |
| 10" CY | | UOM | CPS | MAB |
| | | Code | 15568 | 15662 |
| 60 mm S2 - Both Side Key | Per Set | Price | 3119 | 3189 |
| | | Code | 15569 | 15642 |
| 60 mm S1 - One Side Key and Knob | Per Set | Price | 3159 | 3229 |
| | | Code | 15570 | 15663 |
| 60 mm S4 - Coin and Knob | Per Set | Price | 3119 | 3189 |
| | | | | |
| ON ROSE | | UOM | CPS | MAB |
| | | Code | 15572 | 15665 |
| 60 mm S2 - Both Side Key | Per Set | Price | 3229 | 3299 |
| | | Code | 15573 | 15666 |
| 60 mm S1 - One Side Key and Knob | Per Set | Price | 3269 | 3339 |
| | | Code | 15574 | 15667 |
| 60 mm S4 - Coin and Knob | Per Set | Price | 3229 | 3299 |
| | | Code | 15575 | 15668 |
| OR (Only Rose) With Escutcheons | Per Pair | Price | 2199 | 2259 |
| | | Code | 15576 | 15669 |
| WR Without Escutcheons | Per Set | Price | 1949 | 2019 |

IRIS MORTISE HANDLE

37

CANARY



| 8" CYS | | UOM | FSS | |
|--|----------|-------|------|-------|
| | | | Code | 14543 |
| 60 mm S2 - Both Side Key | Per Set | Price | | 2559 |
| | | | Code | 14544 |
| 60 mm S1 - One Side Key and Knob | Per Set | Price | | 2599 |
| | | | Code | 14545 |
| 60 mm S4 - Coin and Knob | Per Set | Price | | 2559 |
| | | | Code | 14570 |
| KY 8" Lever Cut Lock | Per Set | Price | | 1549 |
| | | | Code | 14571 |
| PKY Bathroom Lock | Per Set | Price | | 1539 |
| | | | | |
| 10" CY | | UOM | FSS | |
| | | | Code | 14552 |
| 60 mm S2 - Both Side Key | Per Set | Price | | 3019 |
| | | | Code | 14553 |
| 60 mm S1 - One Side Key and Knob | Per Set | Price | | 3059 |
| | | | Code | 14554 |
| 60 mm S4 - Coin and Knob | Per Set | Price | | 3019 |
| | | | | |
| ON ROSE | | UOM | FSS | |
| | | | Code | 14561 |
| 60 mm S2 - Both Side Key | Per Set | Price | | 3129 |
| | | | Code | 14562 |
| 60 mm S1 - One Side Key and Knob | Per Set | Price | | 3169 |
| | | | Code | 14563 |
| 60 mm S4 - Coin and Knob | Per Set | Price | | 3129 |
| | | | Code | 14623 |
| OR (Only Rose) With Escutcheons | Per Pair | Price | | 2099 |
| | | | Code | 14575 |
| WR Without Escutcheons | Per Set | Price | | 1849 |

ELIMA



| 8" CYS | | UOM | FSS | |
|--|----------|-------|------|-------|
| | | | Code | 14478 |
| 60 mm S2 - Both Side Key | Per Set | Price | | 2559 |
| | | | Code | 14479 |
| 60 mm S1 - One Side Key and Knob | Per Set | Price | | 2599 |
| | | | Code | 14481 |
| 60 mm S4 - Coin and Knob | Per Set | Price | | 2559 |
| | | | Code | 13513 |
| KY 8" Lever Cut Lock | Per Set | Price | | 1549 |
| | | | Code | 13514 |
| PKY Bathroom Lock | Per Set | Price | | 1539 |
| | | | | |
| 10" CY | | UOM | FSS | |
| | | | Code | 14524 |
| 60 mm S2 - Both Side Key | Per Set | Price | | 3019 |
| | | | Code | 14525 |
| 60 mm S1 - One Side Key and Knob | Per Set | Price | | 3059 |
| | | | Code | 14526 |
| 60 mm S4 - Coin and Knob | Per Set | Price | | 3019 |
| | | | | |
| ON ROSE | | UOM | FSS | |
| | | | Code | 14533 |
| 60 mm S2 - Both Side Key | Per Set | Price | | 3129 |
| | | | Code | 14534 |
| 60 mm S1 - One Side Key and Knob | Per Set | Price | | 3169 |
| | | | Code | 14535 |
| 60 mm S4 - Coin and Knob | Per Set | Price | | 3129 |
| | | | Code | 14622 |
| OR (Only Rose) With Escutcheons | Per Pair | Price | | 2099 |
| | | | Code | 14576 |
| WR Without Escutcheons | Per Set | Price | | 1849 |

**IRIS MORTISE HANDLE****CHERRY**

| 8" CYS | | UOM | CPS | |
|----------------------------------|---------|-------|------|-------------|
| | | | Code | 8342 |
| 60 mm S2 - Both Side Key | Per Set | Price | | 2959 |
| | | | Code | 8071 |
| 60 mm S1 - One Side Key and Knob | Per Set | Price | | 2999 |
| | | | Code | 2541 |
| 60 mm S4 - Coin and Knob | Per Set | Price | | 2959 |
| | | | Code | 5940 |
| KY 8" Lever Cut Lock | Per Set | Price | | 1699 |
| | | | Code | 3210 |
| PKY Bathroom Lock | Per Set | Price | | 1689 |

| 10" CY | | UOM | CPS | |
|----------------------------------|---------|-------|------|-------------|
| | | | Code | 4033 |
| 60 mm S2 - Both Side Key | Per Set | Price | | 3509 |
| | | | Code | 7342 |
| 60 mm S1 - One Side Key and Knob | Per Set | Price | | 3549 |
| | | | Code | 2578 |
| 60 mm S4 - Coin and Knob | Per Set | Price | | 3509 |

| ON ROSE | | UOM | CPS | |
|--|----------|-------|------|-------------|
| | | | Code | 6654 |
| 60 mm S2 - Both Side Key | Per Set | Price | | 3609 |
| | | | Code | 5665 |
| 60 mm S1 - One Side Key and Knob | Per Set | Price | | 3649 |
| | | | Code | 2981 |
| 60 mm S4 - Coin and Knob | Per Set | Price | | 3609 |
| | | | Code | 8170 |
| OR (Only Rose) With Escutcheons | Per Pair | Price | | 2599 |
| | | | Code | 12252 |
| WR Without Escutcheons | Per Set | Price | | 2349 |

KAFE

| 8" CYS | | UOM | SS | |
|----------------------------------|---------|-------|------|-------------|
| | | | Code | 14469 |
| 60 mm S2 - Both Side Key | Per Set | Price | | 2909 |
| | | | Code | 14468 |
| 60 mm S1 - One Side Key and Knob | Per Set | Price | | 2949 |
| | | | Code | 14470 |
| 60 mm S4 - Coin and Knob | Per Set | Price | | 2909 |
| | | | Code | 14477 |
| KY 8" Lever Cut Lock | Per Set | Price | | 1649 |
| | | | Code | 14480 |
| PKY Bathroom Lock | Per Set | Price | | 1639 |

| 10" CY | | UOM | SS | |
|----------------------------------|---------|-------|------|-------------|
| | | | Code | 14482 |
| 60 mm S2 - Both Side Key | Per Set | Price | | 3459 |
| | | | Code | 14483 |
| 60 mm S1 - One Side Key and Knob | Per Set | Price | | 3499 |
| | | | Code | 14484 |
| 60 mm S4 - Coin and Knob | Per Set | Price | | 3459 |

| ON ROSE | | UOM | SS | |
|--|----------|-------|------|-------------|
| | | | Code | 14494 |
| 60 mm S2 - Both Side Key | Per Set | Price | | 3559 |
| | | | Code | 14495 |
| 60 mm S1 - One Side Key and Knob | Per Set | Price | | 3599 |
| | | | Code | 14496 |
| 60 mm S4 - Coin and Knob | Per Set | Price | | 3559 |
| | | | Code | 14621 |
| OR (Only Rose) With Escutcheons | Per Pair | Price | | 2549 |
| | | | Code | 14504 |
| WR Without Escutcheons | Per Set | Price | | 2299 |

IRIS MORTISE HANDLE

AZURE



| 8" CYS | | UOM | FSS | |
|--|----------|-------|------|-------|
| | | | Code | 14585 |
| 60 mm S2 - Both Side Key | Per Set | Price | | 2559 |
| | | | Code | 14586 |
| 60 mm S1 - One Side Key and Knob | Per Set | Price | | 2599 |
| | | | Code | 14587 |
| 60 mm S4 - Coin and Knob | Per Set | Price | | 2559 |
| | | | Code | 14594 |
| KY 8" Lever Cut Lock | Per Set | Price | | 1549 |
| | | | Code | 14595 |
| PKY Bathroom Lock | Per Set | Price | | 1539 |
| | | | | |
| 10" CY | | UOM | FSS | |
| | | | Code | 14598 |
| 60 mm S2 - Both Side Key | Per Set | Price | | 3019 |
| | | | Code | 14599 |
| 60 mm S1 - One Side Key and Knob | Per Set | Price | | 3059 |
| | | | Code | 14600 |
| 60 mm S4 - Coin and Knob | Per Set | Price | | 3019 |
| | | | | |
| ON ROSE | | UOM | FSS | |
| | | | Code | 14609 |
| 60 mm S2 - Both Side Key | Per Set | Price | | 3129 |
| | | | Code | 14610 |
| 60 mm S1 - One Side Key and Knob | Per Set | Price | | 3169 |
| | | | Code | 14611 |
| 60 mm S4 - Coin and Knob | Per Set | Price | | 3129 |
| | | | Code | 14620 |
| OR (Only Rose) With Escutcheons | Per Pair | Price | | 2099 |
| | | | Code | 14619 |
| WR Without Escutcheons | Per Set | Price | | 1849 |

PEACH



| 8" CYS | | UOM | FSS | ATQ |
|--|----------|-------|------|------|
| | | | Code | 3803 |
| 60 mm S2 - Both Side Key | Per Set | Price | | 2659 |
| | | | Code | 5190 |
| 60 mm S1 - One Side Key and Knob | Per Set | Price | | 2699 |
| | | | Code | 2484 |
| 60 mm S4 - Coin and Knob | Per Set | Price | | 2659 |
| | | | Code | 8108 |
| KY 8" Lever Cut Lock | Per Set | Price | | 1649 |
| | | | Code | 3729 |
| PKY Bathroom Lock | Per Set | Price | | 1639 |
| | | | | 1729 |
| | | | | |
| 10" CY | | UOM | FSS | ATQ |
| | | | Code | 4219 |
| 60 mm S2 - Both Side Key | Per Set | Price | | 3119 |
| | | | Code | 6038 |
| 60 mm S1 - One Side Key and Knob | Per Set | Price | | 3159 |
| | | | Code | 2517 |
| 60 mm S4 - Coin and Knob | Per Set | Price | | 3119 |
| | | | | 3189 |
| | | | | |
| ON ROSE | | UOM | FSS | ATQ |
| | | | Code | 3832 |
| 60 mm S2 - Both Side Key | Per Set | Price | | 3229 |
| | | | Code | 4508 |
| 60 mm S1 - One Side Key and Knob | Per Set | Price | | 3269 |
| | | | Code | 3340 |
| 60 mm S4 - Coin and Knob | Per Set | Price | | 3229 |
| | | | Code | 6206 |
| OR (Only Rose) With Escutcheons | Per Pair | Price | | 2199 |
| | | | Code | 1077 |
| WR Without Escutcheons | Per Set | Price | | 1949 |
| | | | | 2019 |

IRIS MORTISE HANDLE



| 8" CYS | | UOM | FSS | ATQ |
|--|----------|-------|-------------|-------------|
| | | Code | 3936 | 1302 |
| 60 mm S2 - Both Side Key | Per Set | Price | 2909 | 2969 |
| | | Code | 5413 | 8558 |
| 60 mm S1 - One Side Key and Knob | Per Set | Price | 2949 | 3009 |
| | | Code | 2508 | 2511 |
| 60 mm S4 - Coin and Knob | Per Set | Price | 2909 | 2969 |
| | | Code | 7770 | 3424 |
| KY 8" Lever Cut Lock | Per Set | Price | 1649 | 1739 |
| | | Code | 3201 | 6856 |
| PKY Bathroom Lock | Per Set | Price | 1639 | 1729 |
| | | | | |
| 10" CY | | UOM | FSS | ATQ |
| | | Code | 5879 | 8716 |
| 60 mm S2 - Both Side Key | Per Set | Price | 3459 | 3519 |
| | | Code | 4175 | 8932 |
| 60 mm S1 - One Side Key and Knob | Per Set | Price | 3499 | 3559 |
| | | Code | 2552 | 2556 |
| 60 mm S4 - Coin and Knob | Per Set | Price | 2459 | 3519 |
| | | | | |
| ON ROSE | | UOM | FSS | ATQ |
| | | Code | 3371 | 3375 |
| 60 mm S2 - Both Side Key | Per Set | Price | 3559 | 3619 |
| | | Code | 3380 | 3382 |
| 60 mm S1 - One Side Key and Knob | Per Set | Price | 3599 | 3659 |
| | | Code | 3385 | 3390 |
| 60 mm S4 - Coin and Knob | Per Set | Price | 3559 | 3619 |
| | | Code | 4436 | 3985 |
| OR (Only Rose) With Escutcheons | Per Pair | Price | 2549 | 2609 |
| | | Code | 12250 | 12251 |
| WR Without Escutcheons | Per Set | Price | 2299 | 2359 |



| 8" CYS | | UOM | CPS |
|--|----------|-------|-------------|
| | | Code | 7468 |
| 60 mm S2 - Both Side Key | Per Set | Price | 2849 |
| | | Code | 3487 |
| 60 mm S1 - One Side Key and Knob | Per Set | Price | 2889 |
| | | Code | 2559 |
| 60 mm S4 - Coin and Knob | Per Set | Price | 2849 |
| | | Code | 6044 |
| KY 8" Lever Cut Lock | Per Set | Price | 1589 |
| | | Code | 3215 |
| PKY Bathroom Lock | Per Set | Price | 1579 |
| | | | |
| 10" CY | | UOM | CPS |
| | | Code | 5535 |
| 60 mm S2 - Both Side Key | Per Set | Price | 3399 |
| | | Code | 4587 |
| 60 mm S1 - One Side Key and Knob | Per Set | Price | 3439 |
| | | Code | 2583 |
| 60 mm S4 - Coin and Knob | Per Set | Price | 3399 |
| | | | |
| ON ROSE | | UOM | CPS |
| | | Code | 7759 |
| 60 mm S2 - Both Side Key | Per Set | Price | 3499 |
| | | Code | 4763 |
| 60 mm S1 - One Side Key and Knob | Per Set | Price | 3539 |
| | | Code | 3370 |
| 60 mm S4 - Coin and Knob | Per Set | Price | 3499 |
| | | Code | 2672 |
| OR (Only Rose) With Escutcheons | Per Pair | Price | 2489 |
| | | Code | 11622 |
| WR Without Escutcheons | Per Set | Price | 2239 |

IRIS MORTISE HANDLE

JADE



| 8" CYS | | UOM | CPS | MAB |
|----------------------------------|---------|-------|-------------|-------------|
| | | Code | 7807 | 1734 |
| 60 mm S2 - Both Side Key | Per Set | Price | 3009 | 3069 |
| | | Code | 7442 | 4567 |
| 60 mm S1 - One Side Key and Knob | Per Set | Price | 3049 | 3109 |
| | | Code | 2856 | 2857 |
| 60 mm S4 - Coin and Knob | Per Set | Price | 3009 | 3069 |
| | | Code | 6167 | - |
| KY 8" Lever Cut Lock | Per Set | Price | 1749 | 1839 |
| | | Code | 7423 | - |
| PKY Bathroom Lock | Per Set | Price | 1739 | 1829 |

| 10" CY | | UOM | CPS | MAB |
|----------------------------------|---------|-------|-------------|-------------|
| | | Code | 6648 | 8437 |
| 60 mm S2 - Both Side Key | Per Set | Price | 3559 | 3619 |
| | | Code | 5967 | 7826 |
| 60 mm S1 - One Side Key and Knob | Per Set | Price | 3599 | 3659 |
| | | Code | 3196 | 3198 |
| 60 mm S4 - Coin and Knob | Per Set | Price | 3559 | 3619 |

| ON ROSE | | UOM | CPS | MAB |
|--|----------|-------|-------------|-------------|
| | | Code | 8714 | 6872 |
| 60 mm S2 - Both Side Key | Per Set | Price | 3659 | 3719 |
| | | Code | 6602 | 6202 |
| 60 mm S1 - One Side Key and Knob | Per Set | Price | 3699 | 3759 |
| | | Code | 3193 | 3190 |
| 60 mm S4 - Coin and Knob | Per Set | Price | 3659 | 3719 |
| | | Code | 7925 | 7703 |
| OR (Only Rose) With Escutcheons | Per Pair | Price | 2649 | 2709 |
| | | Code | 12271 | 3457 |
| WR Without Escutcheons | Per Set | Price | 2399 | 2459 |

SKY



| 8" CYS | | UOM | FSS | MSS | ATQ | MAB |
|----------------------------------|---------|-------|-------------|-------------|-------------|-------------|
| | | Code | 2096 | 2099 | 2104 | 2106 |
| 60 mm S2 - Both Side Key | Per Set | Price | 2909 | 2909 | 2969 | 2969 |
| | | Code | 8391 | 3894 | 6151 | 2116 |
| 60 mm S1 - One Side Key and Knob | Per Set | Price | 2949 | 2949 | 3009 | 3009 |
| | | Code | 2816 | 2817 | 2818 | 2819 |
| 60 mm S4 - Coin and Knob | Per Set | Price | 2909 | 2909 | 2969 | 2969 |
| | | Code | 7179 | - | 7889 | - |
| KY 8" Lever Cut Lock | Per Set | Price | 1649 | - | 1739 | - |
| | | Code | 6069 | - | 6084 | - |
| PKY Bathroom Lock | Per Set | Price | 1639 | - | 1729 | - |

| 10" CY | | UOM | FSS | MSS | ATQ | MAB |
|----------------------------------|---------|-------|-------------|-------------|-------------|-------------|
| | | Code | 5353 | 5321 | 6224 | 6671 |
| 60 mm S2 - Both Side Key | Per Set | Price | 3459 | 3459 | 3519 | 3519 |
| | | Code | 9018 | 5428 | 8322 | 8666 |
| 60 mm S1 - One Side Key and Knob | Per Set | Price | 3499 | 3499 | 3550 | 3559 |
| | | Code | 3077 | 3081 | 3083 | 3085 |
| 60 mm S4 - Coin and Knob | Per Set | Price | 3459 | 3459 | 3519 | 3519 |

| ON ROSE | | UOM | FSS | MSS | ATQ | MAB |
|--|----------|-------|-------------|-------------|-------------|-------------|
| | | Code | 2707 | 2711 | 2713 | 2718 |
| 60 mm S2 - Both Side Key | Per Set | Price | 3559 | 3559 | 3619 | 3619 |
| | | Code | 2720 | 2723 | 2725 | 2728 |
| 60 mm S1 - One Side Key and Knob | Per Set | Price | 3599 | 3599 | 3659 | 3659 |
| | | Code | 2731 | 2734 | 2736 | 2737 |
| 60 mm S4 - Coin and Knob | Per Set | Price | 3559 | 3559 | 3619 | 3619 |
| | | Code | 5726 | 5817 | 5655 | 7657 |
| OR (Only Rose) With Escutcheons | Per Pair | Price | 2549 | 2549 | 2609 | 2609 |
| | | Code | 12259 | - | 12260 | - |
| WR Without Escutcheons | Per Set | Price | 2299 | 2299 | 2359 | 2359 |

BRASS MORTISE COMBO LOCKSETS

| | Item Description | UOM | FSS | ATQ |
|---|----------------------------------|-----------|-------------------|-------------|
| ALIYA  | | | Code 8994 | 4838 |
| | 60 mm S2 - Both Side Key | Per Set | Price 3859 | 3909 |
| | | | Code 6221 | 4781 |
| | 60 mm S1 - One Side Key and Knob | Per Set | Price 3919 | 3979 |
| | | | Code 4199 | 5708 |
| | 8" Lever Cut Lock KY | Per Set | Price 2809 | 2869 |
| | | Code 4862 | 5214 | |
| | Bathroom Lock PKY | Per Set | Price 2699 | 2759 |
| CINDRELLA  | | | Code 7045 | 6798 |
| | 60 mm S2 - Both Side Key | Per Set | Price 4239 | 4289 |
| | | | Code 3517 | 9042 |
| | 60 mm S1 - One Side Key and Knob | Per Set | Price 4299 | 4359 |
| | | | Code 6504 | 4799 |
| | 8" Lever Cut Lock KY | Per Set | Price 3029 | 3079 |
| | | Code 8173 | 3961 | |
| | Bathroom Lock PKY | Per Set | Price 2919 | 2979 |
| LISA  | | | Code 8394 | 6497 |
| | 60 mm S2 - Both Side Key | Per Set | Price 4019 | 4079 |
| | | | Code 8956 | 8950 |
| | 60 mm S1 - One Side Key and Knob | Per Set | Price 4089 | 4139 |
| | | | Code 3452 | 6238 |
| | 8" Lever Cut Lock KY | Per Set | Price 2919 | 2979 |
| | | Code 9043 | 4258 | |
| | Bathroom Lock PKY | Per Set | Price 2809 | 2869 |
| RENO  | | | Code 6994 | 6946 |
| | 60 mm S2 - Both Side Key | Per Set | Price 3709 | 3759 |
| | | | Code 5403 | 5385 |
| | 60 mm S1 - One Side Key and Knob | Per Set | Price 3769 | 3829 |
| | | | Code 5092 | 7805 |
| | 8" Lever Cut Lock KY | Per Set | Price 2699 | 2759 |
| | | Code 7081 | 6891 | |
| | Bathroom Lock PKY | Per Set | Price 2589 | 2649 |





Aliya

Material: Brass
Finishes: FSS, ATQ, SG, GP, SL
Profiles: On Plate

BRASS PULL HANDLES

Inner Pack & Master Pack - 1 / 6

| | | Item Description | UOM | | FSS | SS TWO TONE | ATQ |
|--|-----------------------------|------------------|-------------|-------------|-------------|-------------|------|
|  | | | | Code | 7910 | 6025 | 4528 |
| | Angela 8" Pull On Rose (R) | Per Pc | Price | 2309 | 1849 | 1849 | |
| | | | | Code | 5104 | 4046 | 5836 |
| | Angela 8" Pull On Rose (L) | Per Pc | Price | 2309 | 1849 | 1849 | |
| | | | | Code | 6518 | 5825 | 4883 |
| | Angela 10" Pull On Rose (R) | Per Pc | Price | 3309 | 2309 | 2309 | |
| | | | | Code | 5237 | 5109 | 7328 |
| | Angela 10" Pull On Rose (L) | Per Pc | Price | 3689 | 2949 | 3689 | |
| | | | | Code | 4185 | - | 6278 |
| | Alisa 8" Pull On Rose | Per Pc | Price | 2749 | - | 2749 | |
| | | | | Code | 7689 | - | 7766 |
| | Alisa 10" Pull On Rose | Per Pc | Price | 3189 | - | 3189 | |
| | | | | Code | 4292 | - | 6337 |
| | Edina 8" Pull On Rose (R) | Per Pc | Price | 2559 | - | 2559 | |
| | | | | Code | 4427 | - | 8066 |
| | Edina 8" Pull On Rose (L) | Per Pc | Price | 2559 | - | 2559 | |
| | | | | Code | 3901 | - | 3572 |
| | Edina 10" Pull On Rose (R) | Per Pc | Price | 2959 | - | 2959 | |
| | | | | Code | 5169 | - | 4725 |
| | Edina 10" Pull On Rose (L) | Per Pc | Price | 2959 | - | 2959 | |
| | | | Code | 5233 | - | 5053 | |
| Elko 8" Pull On Rose | Per Pc | Price | 2189 | - | 2189 | | |
| | | | Code | 6321 | - | 1392 | |
| Elko 10" Pull On Rose | Per Pc | Price | 2519 | - | 2519 | | |
| | | | Code | 4223 | 7186 | 8145 | |
| Lynx 8" Pull On Rose | Per Pc | Price | 2949 | 2949 | 2949 | | |
| | | | Code | 3477 | 7069 | 9077 | |
| Lynx 10" Pull On Rose | Per Pc | Price | 4439 | 4439 | 4439 | | |
| | | | Code | 3532 | 8487 | 4360 | |
| Lynx 12" Pull On Rose | Per Pc | Price | 5059 | 5059 | 5059 | | |
| | | | Code | 6512 | 6363 | 4676 | |
| Lynx 15" Pull On Rose | Per Pc | Price | 6249 | 6249 | 6249 | | |
| | | | Code | 7630 | 8628 | 6135 | |
| Lynx 18" Pull On Rose | Per Pc | Price | 6669 | 6669 | 6669 | | |

| Green | Item Description | UOM | | FSS | ATQ | |
|---|------------------------|--------|-------|-------------|-------------|------|
|  | | | Code | 6851 | 5996 | |
| | Green 8" Pull On Rose | Per Pc | Price | 3059 | 3059 | |
| | | | | Code | 6819 | 7547 |
| | Green 10" Pull On Rose | Per Pc | Price | 3749 | 3749 | |

| Opasa | Item Description | UOM | | FSS | ATQ | SG | |
|---|------------------------|--------|-------------|-------------|-------------|-------------|------|
|  | | | Code | 4485 | 8784 | 5014 | |
| | Opasa 8" Pull On Rose | Per Pc | Price | 3059 | 3059 | 4169 | |
| | | | | Code | 7275 | 8428 | 7137 |
| | Opasa 10" Pull On Rose | Per Pc | Price | 3939 | 3939 | 5089 | |
| | | | | Code | 9071 | 7464 | 6115 |
| Opasa 12" Pull On Rose | Per Pc | Price | 4209 | 4209 | 5669 | | |

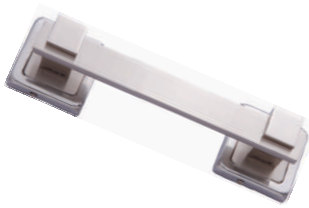
| Martina | Item Description | UOM | | SS Two Tone | ATQ | |
|---|--------------------------|--------|-------------|-------------|-------------|------|
|  | | | Code | 5807 | 2617 | |
| | Martina 8" Pull On Rose | Per Pc | Price | 2469 | 2469 | |
| | | | | Code | 5558 | 3737 |
| | Martina 10" Pull On Rose | Per Pc | Price | 3999 | 3999 | |
| | | | | Code | 7762 | 4594 |
| | Martina 12" Pull On Rose | Per Pc | Price | 4399 | 4399 | |
| | | | | Code | 7235 | 4261 |
| | Martina 15" Pull On Rose | Per Pc | Price | 5599 | 5599 | |
| | | | | Code | 3712 | 3742 |
| | Martina 18" Pull On Rose | Per Pc | Price | 6459 | 6459 | |
| | | | Code | 8034 | 3620 | |
| Martina 24" Pull On Rose | Per Pc | Price | 7269 | 7269 | | |

BRASS PULL HANDLES

Inner Pack & Master Pack - 1 / 6

| VILLA | | UOM | | FSS | SS Two Tone | ATQ | SL | Silver Gold | GP |
|-------|----------------------------|--------|-------|------|-------------|------|-------|-------------|------|
| | | | Code | 6559 | 8826 | 4736 | 6689 | 4970 | 8687 |
| | Villa 8" Pull On Rose (R) | Per Pc | Price | 2869 | 2869 | 2869 | 2869 | 3889 | 3889 |
| | | | Code | 4618 | 8639 | 6726 | 6011 | 8565 | 7125 |
| | Villa 8" Pull On Rose (L) | Per Pc | Price | 2869 | 2869 | 2869 | 2869 | 3899 | 3889 |
| | | | Code | 8478 | 6242 | 7591 | 8526 | 6376 | 6992 |
| | Villa 10" Pull On Rose (R) | Per Pc | Price | 4089 | 4089 | 4089 | 4089 | 5519 | 5519 |
| | | | Code | 7085 | 7816 | 4649 | 6815 | 7868 | 6608 |
| | Villa 10" Pull On Rose (L) | Per Pc | Price | 4089 | 4089 | 4089 | 4089 | 5519 | 5519 |
| | | | Code | 7475 | 7550 | 4938 | 5066 | 7512 | 6679 |
| | Villa 12" Pull On Rose (R) | Per Pc | Price | 4219 | 4219 | 4219 | 4219 | 5709 | 5709 |
| | | | Code | 6998 | 8239 | 5069 | 7290 | 3436 | 4991 |
| | Villa 12" Pull On Rose (L) | Per Pc | Price | 4219 | 4219 | 4219 | 4219 | 5709 | 5709 |
| | | | Code | - | 6629 | 8362 | 3998 | 4824 | 5687 |
| | Villa 15" Pull On Rose (R) | Per Pc | Price | - | 5949 | 5949 | 5949 | 7949 | 7949 |
| | | | Code | - | 6908 | 8329 | 7720 | 4569 | 6936 |
| | Villa 15" Pull On Rose (L) | Per Pc | Price | - | 5949 | 5949 | 5949 | 7949 | 7949 |
| | | | Code | 5355 | 8234 | 3911 | 5360 | 3703 | 6307 |
| | Villa 18" Pull On Rose (R) | Per Pc | Price | 6349 | 6349 | 6349 | 6349 | 8559 | 8559 |
| | | | Code | 3455 | 5630 | 6951 | 12430 | 4213 | 7219 |
| | Villa 18" Pull On Rose (L) | Per Pc | Price | 6349 | 6349 | 6349 | 6349 | 8559 | 8559 |
| | | | Code | 8364 | 6483 | 5781 | 6989 | 8955 | 1044 |
| | Villa GP 12" Glass Pull | Per Pc | Price | 4249 | 4249 | 4249 | 4249 | 5709 | 5709 |
| | | | Code | 7060 | 8561 | 9046 | 6957 | 8729 | 3476 |
| | Villa GP 18" Glass Pull | Per Pc | Price | 6349 | 6349 | 6349 | 6349 | 7949 | 7949 |

| Item Description | | UOM | | SS Two Tone | ATQ | Silver Gold | GP |
|------------------|-----------------------|--------|-------|-------------|------|-------------|------|
| | | | Code | 8124 | 9001 | - | - |
| | Ogha 8" Pull On Rose | Per Pc | Price | 2659 | 2659 | - | - |
| | | | Code | - | - | 6071 | 4520 |
| | Ogha 10" Pull On Rose | Per Pc | Price | - | - | 3599 | 3599 |

| Item Description | | UOM | FSS | SS Two Tone | ATQ | |
|------------------|------------------------|--------|-------|-------------|-------|-------|
| | | | Code | 3992 | 8174 | 7672 |
| | Tessa 12" Pull On Rose | Per Pc | Price | 4459 | 4459 | 4459 |
| | | | Code | 6185 | 5854 | 4961 |
| | Tessa 18" Pull On Rose | Per Pc | Price | 6399 | 6399 | 6399 |
| | | | Code | 8204 | 7561 | 8633 |
| | Tessa 24" Pull On Rose | Per Pc | Price | 8239 | 8239 | 8239 |
| | | | Code | 5820 | 6557 | 7787 |
| | Tessa 36" Pull On Rose | Per Pc | Price | 10789 | 10789 | 10789 |

| Item Description | | UOM | FSS | ATQ | |
|------------------|---------------------------|--------|-------|-------|-------|
| | | | Code | 8828 | 8620 |
| | Texa 10" Pull On Rose | Per Pc | Price | 2869 | 2869 |
| | | | Code | 8931 | 8205 |
| | Yuma 8" Pull On Rose (R) | Per Pc | Price | 2589 | 2589 |
| | | | Code | 12426 | 12427 |
| | Yuma 8" Pull On Rose (L) | Per Pc | Price | 2589 | 2589 |
| | | | Code | 4744 | 3566 |
| | Yuma 10" Pull On Rose (R) | Per Pc | Price | 3839 | 3839 |
| | | | Code | 12428 | 12429 |
| | Yuma 10" Pull On Rose (L) | Per Pc | Price | 3839 | 3839 |



Ogha



Texa



Tessa



Yuma



ASLAN

Aslan 15" Pull On Rose

Finish : ATQ

Code: 5637

Price : 9999/- Per Pc



PULL HANDLES

Inner Pack & Master Pack - 1 / 20

| GP 251 | Length | Dia | 30 mm | | | |
|--------|--------|--------|-------|--|--|--|
| | | Finish | SS | | | |
| | 200mm | Code | 7977 | | | |
| Price | | 2419 | | | | |
| 250mm | Code | 4741 | | | | |
| | Price | 2629 | | | | |
| 300mm | Code | 8576 | | | | |
| | Price | 2839 | | | | |
| 350mm | Code | 15599 | | | | |
| | Price | 3049 | | | | |
| 400mm | Code | 15600 | | | | |
| | Price | 3259 | | | | |
| 450mm | Code | 2245 | | | | |
| | Price | 3469 | | | | |
| 600mm | Code | 15601 | | | | |
| | Price | 3889 | | | | |
| 750mm | Code | 15602 | | | | |
| | Price | 4519 | | | | |
| 900mm | Code | 15603 | | | | |
| | Price | 5149 | | | | |
| 1200mm | Code | 15604 | | | | |
| | Price | 6299 | | | | |

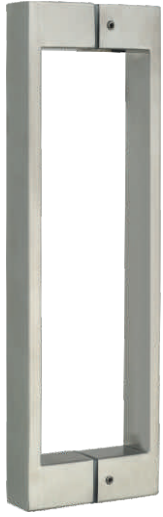

UOM: Per Pair

| GP 3295 | Length | Dia | 40 mm | | | |
|---------|--------|--------|-------|--|--|--|
| | | Finish | SS | | | |
| | 200mm | Code | 2250 | | | |
| Price | | 3479 | | | | |
| 250mm | Code | 2252 | | | | |
| | Price | 3569 | | | | |
| 300mm | Code | 1359 | | | | |
| | Price | 3739 | | | | |
| 450mm | Code | 7718 | | | | |
| | Price | 4819 | | | | |
| 400mm | Code | - | | | | |
| | Price | - | | | | |
| 450mm | Code | - | | | | |
| | Price | - | | | | |
| 600mm | Code | - | | | | |
| | Price | - | | | | |
| 750mm | Code | - | | | | |
| | Price | - | | | | |
| 900mm | Code | - | | | | |
| | Price | - | | | | |
| 1200mm | Code | - | | | | |
| | Price | - | | | | |



UOM: Per Pair

| GP 113 | Length | Dia | 19mm | 22mm | 25mm | 32mm |
|--------|--------|--------|-------|-------|-------|------|
| | | Finish | SS | SS | SS | SS |
| | 200mm | Code | 15606 | 13130 | - | - |
| Price | | 1159 | 1209 | - | - | |
| 250mm | Code | 15607 | 13131 | - | - | |
| | Price | 1299 | 1359 | - | - | |
| 300mm | Code | 15608 | 13132 | - | - | |
| | Price | 1419 | 1469 | - | - | |
| 400mm | Code | - | - | 15611 | - | |
| | Price | - | - | 2309 | - | |
| 450mm | Code | - | - | 15612 | - | |
| | Price | - | - | 2519 | - | |
| 600mm | Code | - | - | - | 13135 | |
| | Price | - | - | - | 3259 | |
| 750mm | Code | - | - | - | 15613 | |
| | Price | - | - | - | 3989 | |
| 900mm | Code | - | - | - | 15614 | |
| | Price | - | - | - | 4619 | |
| 1200mm | Code | - | - | - | 15615 | |
| | Price | - | - | - | 6089 | |



UOM: Per Pair

| GP 121 | Length | Dia | 19mm | 22mm | 25mm | 32mm |
|--------|--------|--------|-------|-------|-------|-------|
| | | Finish | SS | SS | SS | SS |
| | 200mm | Code | - | 13124 | - | 13128 |
| Price | | - | 1679 | - | 2309 | |
| 250mm | Code | - | 13125 | - | 13129 | |
| | Price | - | 1889 | - | 2729 | |
| 300mm | Code | - | 15616 | - | - | |
| | Price | - | 2099 | - | - | |
| 350mm | Code | - | - | 15617 | - | |
| | Price | - | - | 2629 | - | |
| 400mm | Code | - | - | 13127 | - | |
| | Price | - | - | 2839 | - | |
| 450mm | Code | - | - | 15619 | - | |
| | Price | - | - | 3049 | - | |
| 600mm | Code | - | - | - | 15620 | |
| | Price | - | - | - | 3989 | |
| 750mm | Code | - | - | - | 15621 | |
| | Price | - | - | - | 4619 | |
| 900mm | Code | - | - | - | 15622 | |
| | Price | - | - | - | 5149 | |
| 1200mm | Code | - | - | - | 15623 | |
| | Price | - | - | - | 6299 | |



UOM: Per Pair

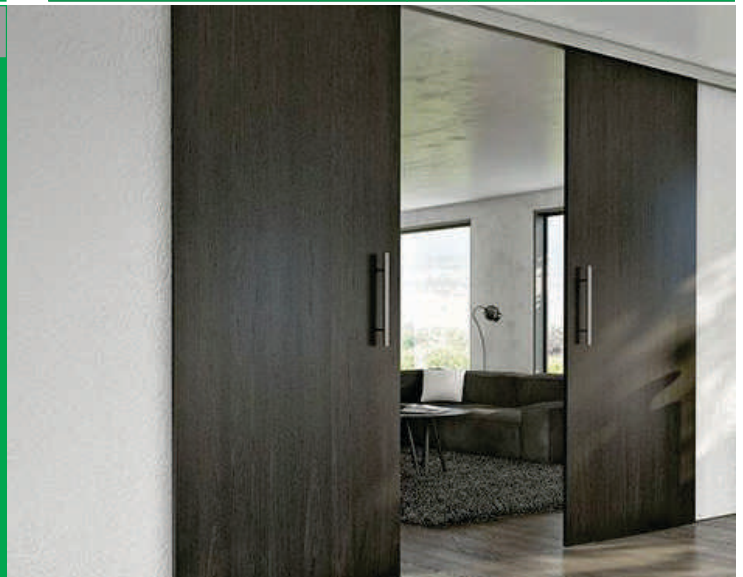

| GP 3010 | SIZE | CODE | FINISH | PRICE |
|---|-----------|------|--------|-------|
|  | 12X80X600 | 2269 | SS | 25999 |

UOM: Per Pair



TOWERBOLTS

Swarovski Towerbolts

| Swarovski Heavy Towerbolts | | Item Description | UOM | FSS | ATQ | GP | Inner Pack | Master Pack |
|--|---------------------------------|------------------|-------|------|------|------|------------|-------------|
|  | | | Code | 9101 | 7242 | 8733 | | |
| | 3" Towerbolts | Per Pc | Price | 2089 | 2089 | 2089 | 10 | 100 |
| | | | Code | 5532 | 6343 | 4987 | | |
| | 4" Towerbolts | Per Pc | Price | 2249 | 2249 | 2249 | 5 | 60 |
| | | | Code | 4321 | 3794 | 5377 | | |
| | 6" Towerbolts | Per Pc | Price | 2569 | 2569 | 2569 | 5 | 60 |
| | | | Code | 5602 | 6912 | 5131 | | |
| | 8" Towerbolts | Per Pc | Price | 2899 | 2899 | 2899 | 5 | 60 |
| | | | Code | 8813 | 3972 | 4010 | | |
| | 10" Towerbolts | Per Pc | Price | 3209 | 3209 | 3539 | 5 | 60 |
| | | | Code | 7334 | 3525 | 8257 | | |
| | 12" Towerbolts | Per Pc | Price | 3559 | 3559 | 3899 | 5 | 12 |
| | | | Code | 4878 | 4665 | 5383 | | |
| | 15" Towerbolts | Per Pc | Price | 4369 | 4369 | 4779 | 5 | 12 |
| | | | Code | 8909 | 7688 | 4481 | | |
| | 18" Towerbolts | Per Pc | Price | 4999 | 4999 | 5769 | 5 | 12 |
| | | Code | 6883 | 3769 | 6706 | | | |
| 24" Towerbolts | Per Pc | Price | 6049 | 6049 | 6789 | 5 | 12 | |
| | | Code | 8571 | 8603 | 7465 | | | |
| 30" Towerbolts | Per Pc | Price | 6859 | 6859 | 7579 | 5 | 12 | |
| | | Code | 7937 | 8606 | 6478 | | | |
| 36" Towerbolts | Per Pc | Price | 8239 | 8239 | 9029 | 5 | 12 | |
| Swarovski Prime Tower Bolts | | Item Description | UOM | FSS | ATQ | GP | Inner Pack | Master Pack |
|  | | | Code | 7859 | 5352 | 3845 | | |
| | 4" Prime Swarovski Tower Bolts | Per Pc | Price | 2249 | 2249 | 2469 | 10 | 100 |
| | | | Code | 7948 | 8316 | 4307 | | |
| | 6" Prime Swarovski Tower Bolts | Per Pc | Price | 2569 | 2569 | 2859 | 5 | 60 |
| | | | Code | 3600 | 4686 | 1613 | | |
| | 8" Prime Swarovski Tower Bolts | Per Pc | Price | 2899 | 2899 | 2969 | 5 | 60 |
| | | | Code | 5790 | 8074 | 5145 | | |
| | 10" Prime Swarovski Tower Bolts | Per Pc | Price | 3209 | 3209 | 3539 | 5 | 60 |
| | | | Code | 3644 | 3428 | 5983 | | |
| | 12" Prime Swarovski Tower Bolts | Per Pc | Price | 3559 | 3559 | 3899 | 5 | 12 |
| | | | Code | 7698 | 5622 | 6691 | | |
| | 15" Prime Swarovski Tower Bolts | Per Pc | Price | 4369 | 4369 | 4779 | 5 | 12 |
| | | | Code | 3555 | 7237 | 7754 | | |
| 18" Prime Swarovski Tower Bolts | Per Pc | Price | 4999 | 4999 | 5759 | 5 | 12 | |
| | | Code | 5564 | 7077 | 8669 | | | |
| 24" Prime Swarovski Tower Bolts | Per Pc | Price | 6049 | 6049 | 6789 | 5 | 12 | |
| | | Code | 7166 | 3738 | 7573 | | | |
| 30" Prime Swarovski Tower Bolts | Per Pc | Price | 6859 | 6859 | 7579 | 5 | 12 | |

Brass Towerbolts

| Brass Premium Heavy Tower Bolts | | Item Description | UOM | FSS | SS Two Tone | ATQ | SL | Silver Gold | GP | Inner Pack | Master Pack |
|---|-------------------------------|------------------|-------|------|-------------|------|------|-------------|------|------------|-------------|
|  | | | Code | 4227 | 8094 | 4364 | 6005 | 8721 | 3937 | | |
| | 3" Premium Heavy Tower Bolts | Per Pc | Price | 349 | 349 | 349 | 289 | 459 | 459 | 10 | 100 |
| | | | Code | 5841 | 6296 | 6301 | 7293 | 4700 | 8465 | | |
| | 4" Premium Heavy Tower Bolts | Per Pc | Price | 459 | 459 | 459 | 399 | 609 | 609 | 10 | 100 |
| | | | Code | 5696 | 7753 | 6777 | 5955 | 4341 | 5735 | | |
| | 6" Premium Heavy Tower Bolts | Per Pc | Price | 689 | 689 | 689 | 579 | 909 | 909 | 5 | 60 |
| | | | Code | 4228 | 3564 | 5531 | 3437 | 7982 | 5689 | | |
| | 8" Premium Heavy Tower Bolts | Per Pc | Price | 919 | 919 | 919 | 769 | 1219 | 1219 | 5 | 60 |
| | | | Code | 7895 | 5829 | 6508 | 6664 | 7033 | 4090 | | |
| | 10" Premium Heavy Tower Bolts | Per Pc | Price | 1159 | 1159 | 1159 | 937 | 1519 | 1519 | 5 | 60 |
| | | | Code | 6347 | 7535 | 6543 | 6488 | 7099 | 8973 | | |
| | 12" Premium Heavy Tower Bolts | Per Pc | Price | 1389 | 1389 | 1389 | 1389 | 1829 | 1829 | 5 | 12 |
| | | | Code | 6667 | 3960 | 7232 | 4385 | 4512 | 5391 | | |
| | 15" Premium Heavy Tower Bolts | Per Pc | Price | 1729 | 1729 | 1729 | 1619 | 2779 | 2279 | 5 | 12 |
| | | | Code | 7350 | 7653 | 8150 | 5370 | 8596 | 8180 | | |
| | 18" Premium Heavy Tower Bolts | Per Pc | Price | 2079 | 2079 | 2079 | 1939 | 2739 | 2739 | 5 | 12 |
| | | | Code | 8564 | 8912 | 4622 | 5289 | 4285 | 5393 | | |
| | 24" Premium Heavy Tower Bolts | Per Pc | Price | 2769 | 2769 | 2769 | 2579 | 3649 | 3649 | 5 | 12 |
| | | Code | 8326 | 8134 | 6718 | 8315 | 7227 | 3948 | | | |
| 30" Premium Heavy Tower Bolts | Per Pc | Price | 3059 | 3459 | 3459 | 3049 | 4589 | 4589 | 5 | 12 | |
| | | Code | 7056 | 5782 | 5295 | 6817 | 7001 | 6514 | | | |
| 36" Premium Heavy Tower Bolts | Per Pc | Price | 4159 | 4159 | 4159 | 3879 | 5479 | 5479 | 5 | 12 | |

TOWERBOLTS

Brass Towerbolts

| Brass Premium Prime Towerbolts | Item Description | UOM | | | | | | Inner Pack | Master Pack | |
|---|------------------------------|--------|-----------|------|------|------|------|------------|-------------|----|
| | | | FSS | MSS | ATQ | MAB | GP | | | |
|  | 4" Premium Prime Towerbolts | Per Pc | Code 6945 | 5126 | 7837 | 8845 | 6285 | 10 | 100 | |
| | | | Price | 559 | 559 | 559 | 559 | 679 | | |
| | | | Code | 6990 | 6132 | 8792 | 4875 | 3847 | 5 | 60 |
| | 6" Premium Prime Towerbolts | Per Pc | Price | 829 | 829 | 829 | 829 | 1079 | | |
| | | | Code | 7143 | 3425 | 8764 | 8736 | 3770 | 5 | 60 |
| | 8" Premium Prime Towerbolts | Per Pc | Price | 1099 | 1099 | 1099 | 1099 | 1349 | | |
| | | | Code | 4584 | 8794 | 8226 | 7098 | 4668 | 5 | 60 |
| | 10" Premium Prime Towerbolts | Per Pc | Price | 1369 | 1369 | 1369 | 1369 | 1689 | | |
| | | | Code | 7814 | 8212 | 6669 | 5965 | 8738 | 5 | 12 |
| | 12" Premium Prime Towerbolts | Per Pc | Price | 1649 | 1649 | 1649 | 1649 | 2029 | | |
| | | | Code | 4985 | 5378 | 5747 | 3513 | 3909 | 5 | 12 |
| | 15" Premium Prime Towerbolts | Per Pc | Price | 1639 | 1639 | 1639 | 1639 | 2529 | | |
| | | | Code | 8643 | 2969 | 8237 | 8058 | 4630 | 5 | 12 |
| | 18" Premium Prime Towerbolts | Per Pc | Price | 2469 | 2469 | 2469 | 2469 | 3029 | | |
| | | Code | 8941 | 6814 | 7574 | 7955 | 8691 | 5 | 12 | |
| 24" Premium Prime Towerbolts | Per Pc | Price | 3289 | 3289 | 3289 | 3289 | 4039 | | | |
| | | Code | 6428 | 3822 | 5336 | 4448 | 6213 | 5 | 12 | |
| 30" Premium Prime Towerbolts | Per Pc | Price | 4099 | 4099 | 4099 | 4099 | 5049 | | | |

Aluminium Tower Bolts

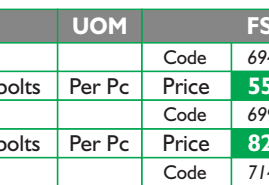
| Prime Aluminium Tower Bolts | Item Description | UOM | | | | | Inner Pack | Master Pack | |
|--|---------------------------------|--------|-----------|------|------|------|------------|-------------|----|
| | | | FSS | MSS | ATQ | MAB | | | |
|  | 4" Prime Aluminium Tower Bolts | Per Pc | Code 4350 | 5146 | 6921 | 7498 | 10 | 100 | |
| | | | Price | 179 | 179 | 179 | 179 | | |
| | | | Code | 8252 | 4841 | 4463 | 6816 | 5 | 60 |
| | 6" Prime Aluminium Tower Bolts | Per Pc | Price | 269 | 269 | 269 | 269 | | |
| | | | Code | 3681 | 3807 | 6298 | 5343 | 5 | 60 |
| | 8" Prime Aluminium Tower Bolts | Per Pc | Price | 349 | 349 | 349 | 349 | | |
| | | | Code | 4737 | 5688 | 8787 | 4172 | 5 | 60 |
| | 10" Prime Aluminium Tower Bolts | Per Pc | Price | 439 | 439 | 439 | 439 | | |
| | | | Code | 5033 | 4328 | 4371 | 7931 | 5 | 12 |
| | 12" Prime Aluminium Tower Bolts | Per Pc | Price | 529 | 529 | 529 | 529 | | |
| | | | Code | 4908 | 6892 | 7100 | 4423 | 5 | 12 |
| | 18" Prime Aluminium Tower Bolts | Per Pc | Price | 799 | 799 | 799 | 799 | | |
| | | | Code | 8825 | 3689 | 4075 | 5036 | 5 | 12 |
| | 24" Prime Aluminium Tower Bolts | Per Pc | Price | 1059 | 1059 | 1059 | 1059 | | |
| | | Code | 8272 | 4129 | 4442 | 8535 | 5 | 12 | |
| 30" Prime Aluminium Tower Bolts | Per Pc | Price | 1329 | 1329 | 1329 | 1329 | | | |
| | | Code | 7076 | 6364 | 7455 | 7144 | 5 | 12 | |
| 36" Prime Aluminium Tower Bolts | Per Pc | Price | 1589 | 1589 | 1589 | 1589 | | | |

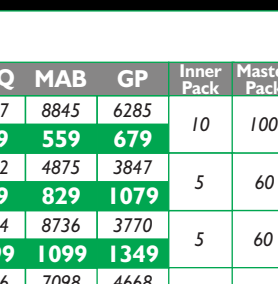
| Square Aluminium Tower Bolts | Item Description | UOM | | | | | Inner Pack | Master Pack | |
|---|----------------------------------|--------|-----------|------|------|------|------------|-------------|----|
| | | | FSS | MSS | ATQ | MAB | | | |
|  | 4" Square Aluminium Tower Bolts | Per Pc | Code 3639 | 7054 | 6764 | 3536 | 10 | 100 | |
| | | | Price | 179 | 179 | 179 | 179 | | |
| | | | Code | 3332 | 2881 | 6288 | 8203 | 5 | 60 |
| | 6" Square Aluminium Tower Bolts | Per Pc | Price | 269 | 269 | 269 | 269 | | |
| | | | Code | 6319 | 4432 | 3502 | 4053 | 5 | 60 |
| | 8" Square Aluminium Tower Bolts | Per Pc | Price | 369 | 369 | 369 | 369 | | |
| | | | Code | 6968 | 5510 | 6042 | 6738 | 5 | 60 |
| | 10" Square Aluminium Tower Bolts | Per Pc | Price | 459 | 459 | 459 | 459 | | |
| | | | Code | 5553 | 6713 | 7548 | 6755 | 5 | 12 |
| | 12" Square Aluminium Tower Bolts | Per Pc | Price | 549 | 549 | 549 | 549 | | |
| | | | Code | 5717 | 8864 | 4393 | 5202 | 5 | 12 |
| | 18" Square Aluminium Tower Bolts | Per Pc | Price | 819 | 819 | 819 | 819 | | |
| | | | Code | 5227 | 5273 | 5743 | 8029 | 5 | 60 |
| | 24" Square Aluminium Tower Bolts | Per Pc | Price | 1089 | 1089 | 1089 | 1089 | | |
| | | Code | 7095 | 7325 | 8006 | 5787 | 5 | 12 | |
| 30" Square Aluminium Tower Bolts | Per Pc | Price | 1369 | 1369 | 1369 | 1369 | | | |
| | | Code | 6300 | 4923 | 4527 | 6434 | 5 | 12 | |
| 36" Square Aluminium Tower Bolts | Per Pc | Price | 1639 | 1639 | 1639 | 1639 | | | |



TOWERBOLTS

SS Towerbolts

| SS Towerbolts | Item Description | UOM | SS | | Inner Pack | Master Pack |
|---|-------------------|--------|------|---------------|------------|-------------|
| | | | Code | Price | | |
|  | 4" SS Towerbolts | Per Pc | 8293 | 89.00 | 10 | 360 |
| | | | 8995 | | | |
| | 6" SS Towerbolts | Per Pc | 7404 | 139.00 | 10 | 240 |
| | | | 6790 | | | |
| | 8" SS Towerbolts | Per Pc | 8443 | 189.00 | 10 | 180 |
| | | | 8647 | | | |
| | 10" SS Towerbolts | Per Pc | | 229.00 | 10 | 120 |
| | | | | | | |
| | 12" SS Towerbolts | Per Pc | | 279.00 | 10 | 120 |
| | | | | | | |
| | 18" SS Towerbolts | Per Pc | | 419.00 | 10 | 120 |

ISI Aluminium Towerbolts

Packaging Standard

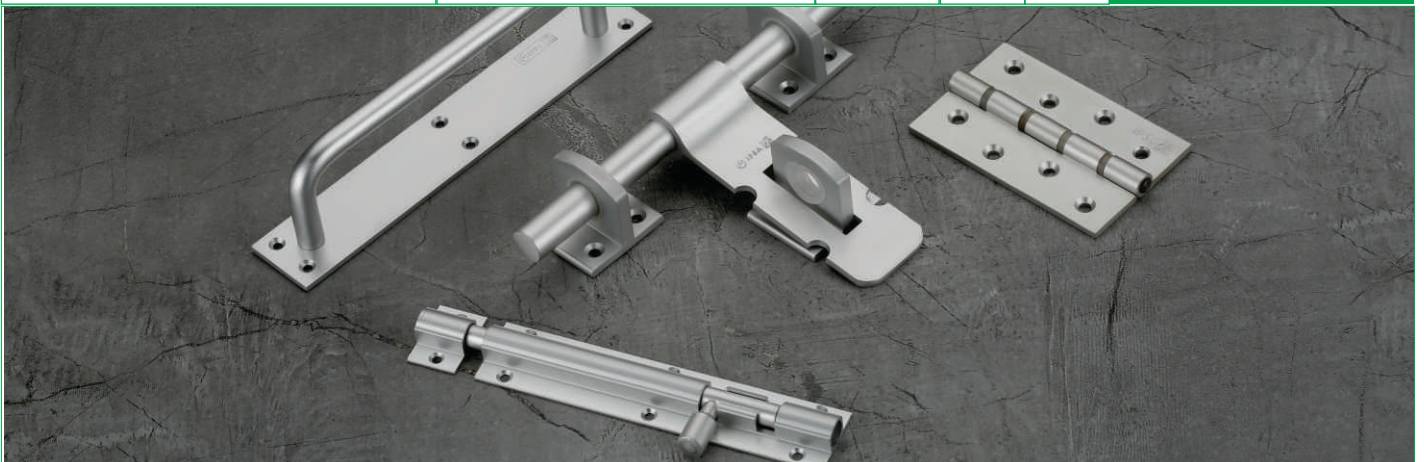

| Item | Item Description | Size | UOM | ISI ALUMINIUM | |
|--|--|----------------|--------|---------------|---------------|
| | | | | Code | Price |
|  IS : 204  CM/L-8650382 | Bolt Dia: 10mm, 12mm Barrel Dia: 11mm, 13mm | Bolt Dia: 10mm | Per Pc | 4128 | |
| | | 100mm | | | 60.00 |
| | | Bolt Dia: 10mm | Per Pc | 6254 | |
| | | 150mm | | | 78.00 |
| | | Bolt Dia: 10mm | Per Pc | 6189 | |
| | | 200mm | | | 98.00 |
| | | Bolt Dia: 10mm | Per Pc | 6699 | |
| | | 250mm | | | 120.00 |
| | | Bolt Dia: 10mm | Per Pc | 4860 | |
| | | 300mm | | | 144.00 |
| | | Bolt Dia: 12mm | Per Pc | 7699 | |
| | | 100mm | | | 90.00 |
| | | Bolt Dia: 12mm | Per Pc | 4877 | |
| | | 150mm | | | 124.00 |
| | | Bolt Dia: 12mm | Per Pc | 7010 | |
| | | 200mm | | | 159.00 |
| | | Bolt Dia: 12mm | Per Pc | 5462 | |
| | | 250mm | | | 192.00 |
| | | Bolt Dia: 12mm | Per Pc | 4035 | |
| | | 300mm | | | 230.00 |

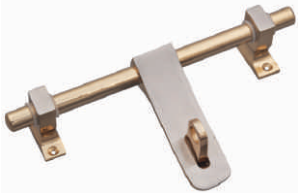

BRASS ALDROPS

| Product | Product Code | Size (In Inch) | Finish | UOM | Price (In Rs) | Inner Pack | Master Pack |
|--|--------------|----------------|-------------|---------|---------------|------------|-------------|
| S - TYPE BRASS ALDROPS | | | | | | | |
|  | 6701 | 8 | FSS | Per Set | 2159.00 | 1 | 20 |
| | 8732 | 8 | ATQ | Per Set | 2219.00 | | |
| | 7899 | 8 | Silver Gold | Per Set | 3169.00 | | |
| | 6563 | 10 | FSS | Per Set | 2529.00 | 1 | 20 |
| | 3916 | 10 | ATQ | Per Set | 2659.00 | | |
| | 8072 | 10 | Silver Gold | Per Set | 3489.00 | | |
| | 8747 | 12 | FSS | Per Set | 2849.00 | 1 | 20 |
| | 3481 | 12 | ATQ | Per Set | 2909.00 | | |
| | 5811 | 12 | Silver Gold | Per Set | 3739.00 | | |
| P - TYPE ALDROPS | | | | | | | |
|  | 7938 | 8 | FSS | Per Set | 2159.00 | 1 | 20 |
| | 5636 | 8 | ATQ | Per Set | 2219.00 | | |
| | 5495 | 8 | Silver Gold | Per Set | 3169.00 | | |
| | 8899 | 10 | FSS | Per Set | 2529.00 | 1 | 20 |
| | 6057 | 10 | ATQ | Per Set | 2659.00 | | |
| | 6473 | 10 | Silver Gold | Per Set | 3489.00 | | |
| | 5175 | 12 | FSS | Per Set | 2849.00 | 1 | 20 |
| | 7397 | 12 | ATQ | Per Set | 2909.00 | | |
| | 7907 | 12 | Silver Gold | Per Set | 3739.00 | | |

STAINLESS STEEL ALDROP

| ALDROP [JAZZ] | | | | | | | | |
|---|--------------|----------------|--------|------|--------|---------------|------------|-------------|
| | Product Code | Size (In Inch) | Finish | Type | UOM | Price (In Rs) | Inner Pack | Master Pack |
|  | 16085 | 8 | SS | 14mm | Per Pc | 189.00 | 6 | 96 |
| | 16086 | 10 | SS | 14mm | Per Pc | 229.00 | 6 | 96 |
| | 16090 | 12 | SS | 14mm | Per Pc | 239.00 | 4 | 72 |
| | 16070 | 8 | SS | 16mm | Per Pc | 339.00 | 4 | 64 |
| | 16071 | 10 | SS | 16mm | Per Pc | 379.00 | 4 | 64 |
| | 16072 | 12 | SS | 16mm | Per Pc | 419.00 | 4 | 48 |
| ALDROP [SLIDE] | | | | | | | | |
|  | 16087 | 8 | SS | 14mm | Per Pc | 189.00 | 6 | 96 |
| | 16088 | 10 | SS | 14mm | Per Pc | 229.00 | 6 | 96 |
| | 16089 | 12 | SS | 14mm | Per Pc | 239.00 | 4 | 72 |
| | 16073 | 8 | SS | 16mm | Per Pc | 339.00 | 4 | 64 |
| | 16074 | 10 | SS | 16mm | Per Pc | 379.00 | 4 | 64 |
| | 16075 | 12 | SS | 16mm | Per Pc | 419.00 | 4 | 48 |
| ALDROP [STRAIGHT] | | | | | | | | |
|  | 16117 | 8 | SS | 14mm | Per Pc | 189.00 | 6 | 96 |
| | 16118 | 10 | SS | 14mm | Per Pc | 229.00 | 6 | 96 |
| | 16119 | 12 | SS | 14mm | Per Pc | 239.00 | 4 | 72 |
| | 16120 | 8 | SS | 16mm | Per Pc | 339.00 | 4 | 64 |
| | 16121 | 10 | SS | 16mm | Per Pc | 379.00 | 4 | 64 |
| | 16122 | 12 | SS | 16mm | Per Pc | 419.00 | 4 | 48 |

ALDROPS

ALUMINIUM ALDROPS

| BISAL8 | | Size (In Inch) | UOM | | Aluminium | Inner Pack | Master Pack |
|--|--|-------------------|--------|-------|-----------|------------|-------------|
|  <p>IS : 2081 CML-8650483</p> <p>Aldrop 200mm with 3 sockets Rod Dia: 16mm</p> | | 200mm | Per Pc | Code | 5990 | 1 | 6 |
| | | | | Price | 280.00 | | |
|  <p>IS : 2081 CML-8650483</p> <p>Aldrop 250mm with 3 sockets Rod Dia: 16mm</p> | | 250mm | Per Pc | Code | 6358 | 1 | 6 |
| | | | | Price | 300.00 | | |
|  <p>IS : 2081 CML-8650483</p> <p>Aldrop 300mm with 4 sockets Rod Dia: 16mm</p> | | 300mm | Per Pc | Code | 5248 | 1 | 6 |
| | | | | Price | 354.00 | | |

SS SCREWS

| | Size | UOM | | SS | Inner Pack |
|---|--------|-----------|-------|-------------|------------|
|  | 19X5 | Per 100pc | Code | IPSF1005698 | 100 Pc |
| | | | Price | 60.00 | |
| | 19X6 | Per 100pc | Code | IPSF1005699 | 100 Pc |
| | | | Price | 62.00 | |
| | 25X6 | Per 100pc | Code | IPSF1005700 | 100 Pc |
| | | | Price | 81.00 | |
| | 30X7 | Per 100pc | Code | IPSF1005701 | 100 Pc |
| | | | Price | 122.00 | |
| | 35X7 | Per 100pc | Code | IPSF1005719 | 100 Pc |
| | | | Price | 133.00 | |
| | 35X8 | Per 100pc | Code | IPSF1005702 | 100 Pc |
| | | | Price | 142.00 | |
| | 60X8 | Per 100pc | Code | IPSF1005721 | 100 Pc |
| | | | Price | 365.00 | |
| | 75X10 | Per 100pc | Code | IPSF1005727 | 100 Pc |
| | | | Price | 800.00 | |
| | 100X10 | Per 100pc | Code | IPSF1005722 | 100 Pc |
| | | | Price | 989.00 | |

DOOR BUFFERS



Wall / Mounted door buffer

| Code | Finish | Price (In Rs) Per Pc | Inner Pack | Master Pack |
|------|--------|----------------------|------------|-------------|
| 5112 | SS | 149.00 | 20 | 400 |



Half Moon Sphere Type

| Code | Finish | Price (In Rs) Per Pc | Inner Pack | Master Pack |
|------|--------|----------------------|------------|-------------|
| 5019 | SS | 189.00 | 20 | 240 |



Door Buffer Black

| Code | Finish | Price (In Rs) Per Pc | Bag |
|------|--------|----------------------|--------|
| 6573 | Black | 33.00 | 500 Pc |



Door Buffer White

| Code | Finish | Price (In Rs) Per Pc | Inner Pack | Master Pack |
|------|--------|----------------------|------------|-------------|
| 7287 | White | 33.00 | 30 | 300 |

DOOR ACCESSORIES



| Inner Pack & Master Pack: 10/1200 | | | |
|-----------------------------------|------------------|--------|----------------------|
| Code | Description | Finish | Price (In Rs) Per Pc |
| 1956 | Magnetic Catcher | White | 24.00 |



| Inner Pack & Master Pack: 10/60 | | | |
|---------------------------------|-----------------------|--------|----------------------|
| Code | Description | Finish | Price (In Rs) Per Pc |
| 1946 | Rotating Door Stopper | SS | 1499.00 |



| Inner Pack & Master Pack: 10/200 | | | |
|----------------------------------|------------------------|--------|----------------------|
| Code | Description | Finish | Price (In Rs) Per Pc |
| 1965 | Sliding Latch (3 Inch) | FSS | 199.00 |
| 1966 | Sliding Latch (5 Inch) | FSS | 339.00 |



| Inner Pack & Master Pack: 12/600 | | | |
|----------------------------------|-------------------|--------|----------------------|
| Code | Description | Finish | Price (In Rs) Per Pc |
| 6792 | Door Viewer Big | FSS | 479.00 |
| 8652 | Door Viewer Small | FSS | 139.00 |



| Inner Pack & Master Pack: 1/50 | | | |
|--------------------------------|-------------------------------|------------|----------------------|
| Code | Description | Finish | Price (In Rs) Per Pc |
| 4498 | Steel Door Chain With Leather | Black / SS | 639.00 |
| 8512 | Concealed Door Chain | SS | 849.00 |



| Inner Pack & Master Pack: 1/60 | | | |
|--------------------------------|---------------------|--------|----------------------|
| Code | Description | Finish | Price (In Rs) Per Pc |
| 7061 | Door Guard Standard | SS | 699.00 |
| 8350 | Door Guard Premium | CPB | 799.00 |



GATE HOOK

FINISH: SS

| Code | Size | Price (In Rs) Per PC | UOM |
|-------|-----------------|----------------------|-----|
| 9452 | 125 mm/ 5" Inch | 26.00 | PC |
| 11463 | 150 mm/ 6" Inch | 29.00 | |



GATE HOOK

| Inner Pack & Master Pack: 10/200 | | | |
|----------------------------------|--------------------|--------|----------------------|
| Code | Description | Finish | Price (In Rs) Per Pc |
| 5641 | Gate Hook (6 Inch) | FSS | 259.00 |

DOOR STOPPERS

Brass Door Stoppers



PLAIN

Door Stoppers

| Code | Finish | Price (In Rs) Per Pc | Inner Pack | Master Pack |
|------|--------|----------------------|------------|-------------|
| 5315 | FSS | 619.00 | | |
| 5974 | ATQ | 649.00 | 6 | 120 |
| 6350 | FSL | 679.00 | | |



OPASA

Door Stoppers

| Code | Finish | Price (In Rs) Per Pc | Inner Pack | Master Pack |
|------|--------|----------------------|------------|-------------|
| 8510 | FSS | 619.00 | | |
| 4083 | ATQ | 649.00 | 6 | 120 |
| 6746 | FSL | 679.00 | | |



BULLET

Door Stoppers

| Code | Finish | Price (In Rs) Per Pc | Inner Pack | Master Pack |
|------|--------|----------------------|------------|-------------|
| 6613 | FSS | 409.00 | 20 | 240 |

Magnetic Door Stoppers



Door Stopper
801 for Light Doors

| Code | Finish | Price (In Rs) Per Pc | Inner Pack | Master Pack |
|------|--------|----------------------|------------|-------------|
| 5196 | SS | 169.00 | 40 | 160 |



Door Stopper
802 for Medium Doors

| Code | Finish | Price (In Rs) Per Pc | Inner Pack | Master Pack |
|------|--------|----------------------|------------|-------------|
| 7449 | ATQ | 249.00 | 40 | 160 |



Door Stopper
802 for Medium Doors

| Code | Finish | Price (In Rs) Per Pc | Inner Pack | Master Pack |
|------|--------|----------------------|------------|-------------|
| 6879 | SS | 209.00 | 40 | 160 |

Zamak Door Stoppers



CYAN

Door Stoppers

| Code | Finish | Price (In Rs) Per Pc | Inner Pack | Master Pack |
|------|--------|----------------------|------------|-------------|
| 5485 | FSS | 319.00 | 20 | 240 |
| 6918 | ATQ | 329.00 | | |



Door Stopper
835 For Heavy Doors Square

| Code | Finish | Price (In Rs) Per Pc | Inner Pack | Master Pack |
|------|--------|----------------------|------------|-------------|
| 3966 | SS | 699.00 | 40 | 160 |

Stainless Steel Door Stoppers



DOOR STOPPER [1 LEG]

| Code | Finish | Price (In Rs) Per PC | UOM |
|--------|--------|----------------------|-----|
| 107110 | SS202 | 94.00 | PC |



DOOR STOPPER [2 LEG]

| Code | Finish | Price (In Rs) Per PC | UOM |
|-------|--------|----------------------|-----|
| 13122 | SS202 | 119.00 | PC |
| 15746 | SS304 | 259.00 | PC |

Aluminium Door Stoppers



DOOR STOPPER [1 LEG]

| Code | Finish | Price (In Rs) Per PC | UOM |
|-------|--------|----------------------|-----|
| 12556 | SS | 69.00 | PC |
| 12555 | Champ | 69.00 | PC |



DOOR STOPPER [2 LEG]

| Code | Finish | Price (In Rs) Per PC | UOM |
|-------|--------|----------------------|-----|
| 12551 | SS | 89.00 | PC |
| 12550 | Champ | 89.00 | PC |

Welded Hinges

Capped Hinges



BUTT STAINLESS STEEL HINGES CONCEALED WELDED

| Code | Size | Price (In Rs) Per PC |
|------|------|----------------------|
| HI42 | 3X14 | 61 |
| HI38 | 3X12 | 83 |
| HI43 | 4X14 | 91 |
| HI39 | 4X12 | 116 |
| HI44 | 5X14 | 116 |
| HI40 | 5X12 | 146 |
| HI41 | 6X12 | 192 |

SS 202



BUTT STAINLESS STEEL HINGES PIN TYPE

| Code | Size | Price (In Rs) Per PC |
|------|------|----------------------|
| HI32 | 3X16 | 43 |
| HI45 | 3X14 | 56 |
| HI31 | 3X12 | 70 |
| HI33 | 4X14 | 83 |
| HI34 | 4X12 | 104 |
| HI35 | 5X14 | 104 |
| HI36 | 5X12 | 137 |
| HI37 | 6X12 | 181 |

SS 202



BUTT HINGES WELDED (only for bulk orders)

| Code | Size | Price (In Rs) Per PC |
|------|------|----------------------|
| HI23 | 3X12 | 134 |
| HI24 | 4X12 | 204 |
| HI25 | 5X12 | 244 |
| HI26 | 6X12 | 309 |

SS 304



BUTT STAINLESS STEEL HINGES CONCEALED WELDED (only for bulk orders)

| Code | Size | Price (In Rs) Per PC |
|------|------|----------------------|
| HI61 | 3X12 | 105 |
| HI62 | 4X12 | 151 |
| HI63 | 5X12 | 188 |
| HI64 | 6X12 | 224 |

SS 304

Non- Ball Bearing Hinges Welded



| Code | Size | Price (In Rs) Per PC |
|------|---------|----------------------|
| HI17 | 4X3X3 | 204 |
| HI53 | 4X3.5X3 | 234 |
| HI18 | 5X3X3 | 234 |
| HI59 | 5X3X4 | 270 |
| HI54 | 5X3.5X3 | 270 |
| HI19 | 6X3X3 | 270 |

SS 202



BUTT STAINLESS STEEL HINGES CONCEALED WELDED (only for bulk orders)

| Code | Size | Price (In Rs) Per PC |
|------|------|----------------------|
| HI65 | 3X12 | 163 |
| HI66 | 4X12 | 230 |
| HI67 | 5X12 | 281 |
| HI68 | 6X12 | 328 |

SS 316

ATQ Welded Hinges

ATQ Ball Bearing Hinges

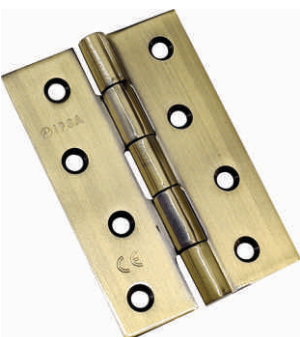

BUTT HINGES WELDED ATQ

| Code | Size | Price (In Rs) Per PC |
|---------|------|----------------------|
| HATQ138 | 3X12 | 99 |
| HATQ139 | 4X12 | 142 |
| HATQ140 | 5X12 | 185 |
| HATQ141 | 6X12 | 238 |
| HATQ169 | 5X10 | 287 |
| HATQ170 | 4X10 | 250 |



| Code | Size | Price (In Rs) Per PC |
|---------|-----------|----------------------|
| HATQ171 | 3X2.5X2.5 | - |
| HATQ109 | 4X3X3 | 280 |
| HATQ110 | 5X3X3 | 360 |
| HATQ172 | 6X3X3 | - |

DOOR HINGES

Riveted Ball Bearing Hinges



| Code | Size | Price (In Rs) Per PC |
|------|-----------|----------------------|
| H101 | 3X2.5X2.5 | 195 |
| H102 | 4X3X3 | 333 |
| H103 | 4X3.5X3 | 389 |
| H104 | 5X3X3 | 389 |
| H105 | 5X3.5X3 | 468 |
| H106 | 6X3X3 | 468 |

SS 304

Ball Bearing Hinges SS202 CAPPED



| Code | Size | Price (In Rs) Per PC |
|------|---------|----------------------|
| H107 | 3" | 168 |
| H108 | 4X3X2.5 | 204 |
| H109 | 4X3X3 | 234 |
| H110 | 5X3X3 | 319 |
| H111 | 5X3X2.5 | 234 |
| H112 | 6X3X3 | 348 |

SS 202

Premium Brass Bearing Hinges



| Size | | ATQ | FSS | GP | SG | SL | SS |
|---------|--------------|------|------|------|------|------|------|
| | Code | 5469 | 5849 | 4272 | 5051 | 8753 | 8545 |
| 3X3X2.5 | Price per Pc | 419 | 419 | 539 | 539 | 409 | 419 |
| | Code | 8618 | 4941 | 4477 | 7038 | 3764 | 3731 |
| 4X3X3 | Price per Pc | 889 | 889 | 1019 | 1019 | 799 | 889 |
| | Code | 3628 | 7003 | 8598 | 6335 | 5880 | 4633 |
| 5X3X3 | Price per Pc | 1099 | 1099 | 1229 | 1229 | 1009 | 1099 |
| | Code | 7833 | 7946 | 5324 | 3782 | 8838 | 1011 |
| 5X3.5X5 | Price per Pc | 1689 | 1689 | 1799 | 1799 | 1569 | 1689 |
| | Code | 8223 | 4909 | 6547 | 5649 | 8797 | 6444 |
| 6X3.5X5 | Price per Pc | 1999 | 1999 | 2129 | 2129 | 1899 | 1990 |

Cut Stainless Steel Hinges



| Code | Size | Price (In Rs) Per PC |
|-------|------------|----------------------|
| 14044 | 3X1/2X3/4H | 30 |
| 14045 | 3X1/2X3/4L | 28 |
| 14046 | 3X3/4X3/4 | 30 |
| 14047 | 3XAssam | 32 |

Aluminum Butt Hinges

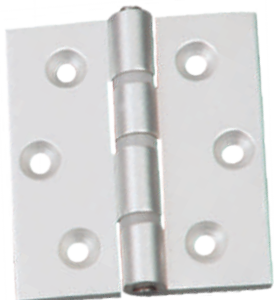

| Code | Item Description | Size | Price (In Rs) Per PC |
|------|--|-------|----------------------|
| 5919 | Width: 31.75mm Diameter: 11mm Thickness: 4mm | 75mm | 76 |
| 5305 | | 100mm | 100 |
| 6583 | | 125mm | 120 |



Premium Brass Railway Hinges



| Size | | ATQ | FSS | GP | SG | SL | SS |
|------------|--------------|------|------|------|------|------|------|
| | Code | 8178 | 5008 | 8405 | 6187 | 5163 | 3926 |
| 3X3/4X3/32 | Price per Pc | 399 | 399 | 469 | 469 | 309 | 399 |
| | Code | 5601 | 5523 | 5401 | 3804 | 3518 | 9039 |
| 3X7/8X3/32 | Price per Pc | 409 | 409 | 489 | 489 | 319 | 409 |
| | Code | 6012 | 4152 | 6887 | 5947 | 4634 | 7797 |
| 4X1X1/8 | Price per Pc | 529 | 529 | 659 | 659 | 449 | 529 |
| | Code | 4283 | 2661 | 4511 | 7906 | 8128 | 3589 |
| 4X9/8X1/8 | Price per Pc | 629 | 629 | 809 | 809 | 519 | 629 |
| | Code | 5493 | 4462 | 7702 | 8860 | 7526 | 3657 |
| 4X9/8X5/32 | Price per Pc | 789 | 789 | 919 | 919 | 679 | 789 |
| | Code | 8025 | 8398 | 8219 | 8796 | 7943 | 8296 |
| 5X9/8X1/8 | Price per Pc | 799 | 799 | 959 | 959 | 659 | 799 |
| | Code | 7969 | 4939 | 5659 | 4611 | 8007 | 8600 |
| 6X9/8X1/8 | Price per Pc | 1100 | 1100 | 1399 | 1399 | 909 | 1100 |
| | Code | 5818 | 6550 | 3902 | 6702 | 6703 | 5182 |
| 6X9/8X5/32 | Price per Pc | 1209 | 1209 | 1479 | 1479 | 969 | 1209 |

ALUMINIUM ISI DOOR HANDLE

Packaging Standard

| Item | | Size | UOM | | ISI Aluminium |
|---|--|-------|--------|-------|---------------|
|   | BISDH3 Door Handle with inner grip 75mm Plate (H x W): 115mm x 30mm Rod Dia: 10mm | 75mm | Per Pc | Code | 5927 |
| | | | | Price | 57 |
| | BISDH4 Door Handle with inner grip 100mm Plate (H x W): 150 x 30mm Rod Dia: 10mm | 100mm | Per Pc | Code | 8279 |
| | | | | Price | 70 |
| | BISDH5 Door Handle with inner grip 125mm Plate (H x W): 175mm x 35mm Rod Dia: 12mm | 125mm | Per Pc | Code | 5898 |
| | | | | Price | 102 |
| | BISDH6 Door Handle with inner grip 150mm Plate (H x W): 200mm x 35mm Rod Dia: 12mm | 150mm | Per Pc | Code | 8457 |
| | | | | Price | 114 |

SS DOOR HANDLE

| C-TYPE | | Size | UOM | | SS |
|---|--|---------|--------|-------|-------|
|  | SS HANDLE C-TYPE [12 GAUGE] | 125mm | Per Pc | Code | 16076 |
| | | | | Price | 39 |
| | | 150mm | Per Pc | Code | 16077 |
| | | | | Price | 44 |
|  | SS HANDLE D-TYPE [12 GAUGE] | 125mm | Per Pc | Code | 15873 |
| | | | | Price | 39 |
| | | 150mm | Per Pc | Code | 15823 |
| | | | | Price | 44 |
|  | SS HANDLE LAHAR [12 GAUGE] | 125mm | Per Pc | Code | 16125 |
| | | | | Price | 39 |
| | | 150mm | Per Pc | Code | 16124 |
| | | | | Price | 44 |
|  | SS HANDLE ON PLATE / WITH PLATE | 4" Inch | Per Pc | Code | 16232 |
| | | | | Price | - |
| | | 5" Inch | Per Pc | Code | 16231 |
| | | | | Price | - |
| | | 6" Inch | Per Pc | Code | 14678 |
| | | | | Price | - |

GLASS FITTING

IP100



Load Capacity: **upto 100 KG**
 Dimensions (in mm):
2480 x 1010
 Cycle Tested: **5,00,000**

| Code | Pkg | Price (In Rs) Per PC |
|-------|--------|----------------------|
| 11952 | 02 Pcs | 4199 |

IP150



Load Capacity: **upto 120 KG**
 Dimensions (in mm):
3100 x 1100
 Cycle Tested: **5,00,000**

| Code | Pkg | Price (In Rs) Per PC |
|-------|--------|----------------------|
| 13354 | 04 Pcs | 5249 |

IP811



Load Capacity: **upto 120 KG**
 Dimensions (in mm):
2970 x 1000
 Cycle Tested: **5,00,000**
(With IP/BP)

| Code | Pkg | Price (In Rs) Per PC |
|------|--------|----------------------|
| 9727 | 04 Pcs | 5349 |

IP130



Load Capacity: **upto 80 KG**
 Dimensions (in mm):
3200 x 1300
 Cycle Tested: **5,00,000**
(With Out IP/BP)

| Code | Pkg | Price (In Rs) Per PC |
|------|--------|----------------------|
| 1062 | 04 Pcs | 4889 |

IPFS90

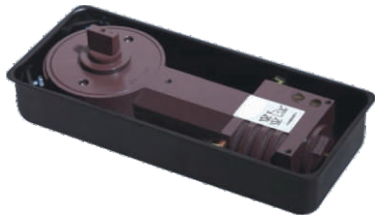

Load Capacity: **80 Kg**
 Cycle Tested: **3,00,000**

| Code | Pkg | Price (In Rs) Per PC |
|-------|--------|----------------------|
| 10912 | 04 Pcs | 3459 |

Super Spring



Load Capacity: **upto 80 KG**
 Cycle Tested **10, 00, 000**
 L-306 mm X W-108 mm X H-40mm
 Tested as Per: **EN 1154**
 Hold Open (Standard): **90 hold open**
 CE certified : **Yes**

| Code | Pkg | Price (In Rs) Per PC |
|-------|--------|----------------------|
| 13533 | 04 Pcs | 9449 |

IPFS90 Combo Set Weight Capacity upto 80 kg

Top Patch, Bottom Patch, Lock & Floor Spring

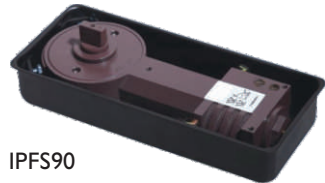

IPFS90



IP01



IP02



IP05



IP49

| Code | Pkg | Price (In Rs) Per PC |
|------|---------|----------------------|
| 2359 | Per Set | 7349 |

IP130 Combo Set Weight Capacity upto 80 kg

Top Patch, Bottom Patch, Lock & Floor Spring



IP130



IP01



IP02



IP05



IP49

| Code | Pkg | Price (In Rs) Per PC |
|------|---------|----------------------|
| 2360 | Per Set | 8709 |

IP150 Combo Set Weight Capacity 120-150 kg

Top Patch, Bottom Patch, Lock & Floor Spring



IP150



IP01



IP02



IP05



IP49

| Code | Pkg | Price (In Rs) Per PC |
|------|---------|----------------------|
| 2361 | Per Set | 9239 |

Super Spring Combo Set Weight Capacity upto 80 kg

Top Patch, Bottom Patch, Lock & Floor Spring



Super Spring



IP01



IP02



IP05



IP49

| Code | Pkg | Price (In Rs) Per PC |
|-------|---------|----------------------|
| 14580 | Per Set | 13439 |

IPFS90

Combo Set

Top Patch, Bottom Patch & Floor Spring

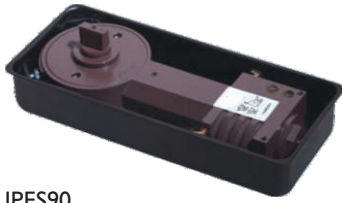

IPFS90



IP02



IP49



IP01

| Code | UOM | Price (In Rs) Per PC |
|-------|---------|-------------------------|
| 14648 | Per Set | 5309 |

IP130

Combo Set

Top Patch, Bottom Patch & Floor Spring



IP130



IP02



IP49



IP01

| Code | UOM | Price (In Rs) Per PC |
|-------|---------|-------------------------|
| 14649 | Per Set | 6779 |

IP150

Combo Set

Top Patch, Bottom Patch & Floor Spring



IP150



IP02



IP49



IP01

| Code | UOM | Price (In Rs) Per PC |
|-------|---------|-------------------------|
| 14650 | Per Set | 7349 |

Super Spring

Combo Set

Top Patch, Bottom Patch & Floor Spring



Super Spring



IP02



IP49



IP01

| Code | UOM | Price (In Rs) Per PC |
|-------|---------|-------------------------|
| 14651 | Per Set | 11439 |

IP01

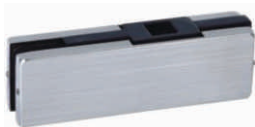

Bottom patch with
SS304 Cover Plates
Finish: **SS**
Pkg. 20Pcs

| Code | UOM | Price (In Rs) Per PC |
|------|--------|-------------------------|
| 4017 | Per Pc | 1099 |

IP02



Top patch with
SS304 Cover Plates
Finish: **SS**
Pkg. 20Pcs

| Code | UOM | Price (In Rs) Per PC |
|------|--------|-------------------------|
| 7492 | Per Pc | 1149 |

IP03



Over Panel patch with
SS304 Cover Plates
Finish: **SS**
Pkg. 20Pcs

| Code | UOM | Price (In Rs) Per PC |
|------|--------|-------------------------|
| 6204 | Per Pc | 1419 |

IP04



Over panel side panel connecting
patch with SS304 Cover Plates
Finish: **SS**
Pkg. 20Pcs

| Code | UOM | Price (In Rs) Per PC |
|------|--------|-------------------------|
| 5904 | Per Pc | 2049 |

IP05



Bottom patch lock and cylinder
with SS304 Cover Plates
Finish: **SS**
Pkg. 20Pcs

| Code | UOM | Price (In Rs) Per PC |
|-------|--------|-------------------------|
| 11923 | Per Pc | 2469 |

IP49



Top pivot with
SS304 Cover Plates
Finish: **SS**
Pkg. 200Pcs

| Code | UOM | Price (In Rs) Per PC |
|------|--------|-------------------------|
| 8154 | Per Pc | 369 |

Terms & Conditions:-

1. The pricelist supersedes all our previous pricelists.
2. All prices are FOB Delhi.
3. Prices are subjected to change without prior notice.
4. The Above prices are applicable w.e.f. July 2021.
5. Orders should be as per guidelines of the company and in writing.
6. Discount may vary from product to product in pricelist.
7. Any Damaged goods or short material received must be immediately notified and discrepancy must be clearly mentioned on delivery receipt.
8. No material for return shall be accepted by the company, in case valid claim is not filed in writing within 1 month



IPSA Business (India) Pvt. Ltd.

57/1/17-18 Site IV, Industrial Area, Sahibabad 201010, Distt. Ghaziabad. (U.P.) India

Customercare Division: Ph +91 120 4536600 (100 Lines) Fax: +91-120-4536666

E-mail: customercare@ipsaindia.com, ipsa@ipsaindia.com

Website: www.ipsaindia.com