

MRP w.e.f 15th June `21

Complete Architectural Hardware Solutions

Edition #12



Download Ozone India App



 **Android**



 **iOS**

Ozone continues with the concept of "Total Vision" to create transparent & elegant commercial spaces. Every fitting in our architectural glass hardware range is designed to meet the concept of "Total Vision".

Ozone, a leading name in architectural hardware domain, offers high quality architectural hardware & safety solutions worldwide. It has achieved many accolades internationally for its innovative and technologically advanced products and solutions. Its manufacturing capability enables it to offer turnkey projects of all sizes. The design team includes architects, product designers & structural engineers who innovate and support the customers and project managers. Offering more than 3000 products from its portfolio intelligently divided into 09 broad categories based on application. Ozone has been continuously innovating to offer best solutions complying with international norms of safety & quality.

Manufacturing Capability

Our state-of-the-art manufacturing units located in India and overseas enable us to provide Standard and Customized Architectural Hardware & Infrastructural Solutions in Stainless Steel.

Our strengths are:

- Over 20 years extensive experience of operating in Architectural Hardware Industry and Digital Safes
- Dedicated 20 years technically experienced team
- Advanced automated machines & tools
- Ability to undertake OEM & ODM projects
- In-house R & D set-up for offering right mix of design, cost, quality and delivery
- Project support & customer service team



CNC Laser Cutting Machine



AUTOMATED STATE-OF-THE-ART Manufacturing Facility

Our manufacturing units are equipped with the latest and technologically advanced machines. These comprise CNC laser cutting machine, CNC water jet cutting machine, CNC shearing machine, robotic welding & automatic polishing machines that enable us to manufacture all types of hardware fittings in stainless steel material and finish, standard as well as customized, as per international safety & quality norms.



Scan QR Code for
Manufacturing Facility

Location:

Kala Amb
Himachal Pradesh
India



VMC (Vertical Machine Center)

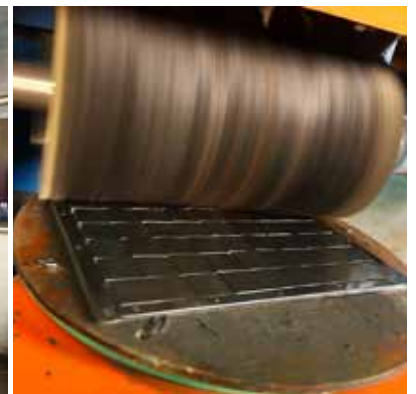

Polishing Machine



CNC Punching Machine



Welding Centre

Ozone Product SBUs

Our product portfolio offers more than 3000 SKUs, intelligently divided into 09 broad categories. We constantly endeavour to innovate products for offering better solutions that deliver enhanced value to our discerning customers world over such as architects, builders, contractors, fabricators, specifiers, consultants and home owners.

OZONE HARDWARE

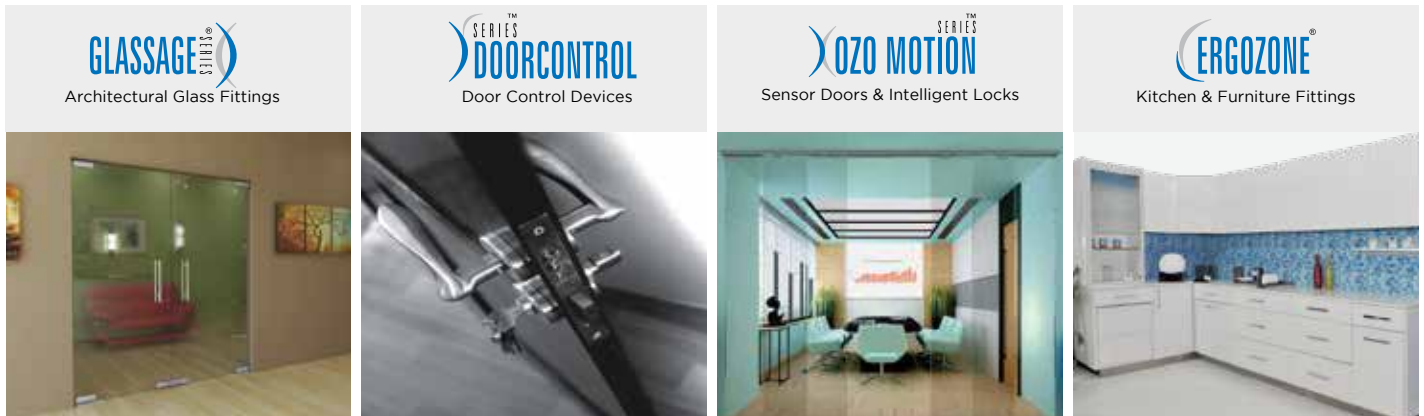

OZONE METALSCAPES

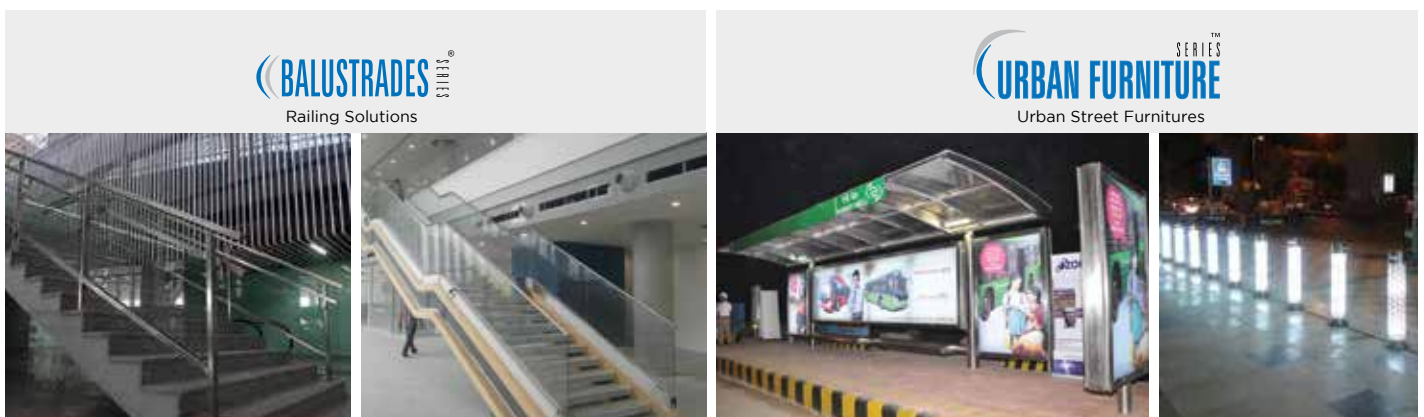

OZONE SECUTECH



INDEX...



Glass Door Patch Fittings & Locks & Pivot Hinge	1-7
Hydraulic Hinges For Glass Doors	8
The Original Self-closing Patch Fitting	9-11
Glass Door Handles With & Without Lock	13-15
Shower Cubicle Fittings & Door Systems	16-24
Sliding Door Systems	25-29
Sliding Glass Door Locks	30-31
Sliding Folding System for Glass Panels	32-34
Movable Glass Portioning Systems	35-36
Glass Facade Spider Fittings	37-42



Automatic Sliding Door Systems	44-53
Motion Sensors	54-55
Automatic Swing Door Systems	57-58
Revolving Doors	59-60
Hermetically Sealed & X-Ray Shielding Doors	61
Movable Acoustic Wall Partition Systems	62-63
Hotel RFID Locks & Digital Glass Door Locks	64-65



Door Handles	67-70
Mortise Lock Body	71-72
Night Latch & Cylindrical Knob Locks	73
Door Accessories	75-76
Fire Rated Panic Door Hardware & Accessories	77-78
The Original Self-closing Patch Fitting	79
Floor Springs, Transom Closers & Accessories	80-83
Door Closers & Accessories	84-88
Sliding Door Systems	89-91
Sliding Folding System for Framed/Wooden Doors	92-93

BLACK MATT FITTINGS

Door Hardware & Glass Door Fittings	95-96
Shower Cubicle Fittings	97
Glass Door Locks	98



GLASSAGE[®] SERIES

ARCHITECTURAL GLASS FITTINGS

Ozone offers an extensive collection of Glass Door Hardware to create different door configurations using combination of various fittings & accessories. A wide range of patch fittings is presented here from this collection. Available in different finishes and designs, these patch fittings meet the functional as well as aesthetic need of a space. Every hardware fitting undergoes stringent tests for quality, stability & safety as per international standards in testing parameters.

STANDARD PATCH FITTINGS

Finish : SSS



OPF-1 STD SSS ₹ 3,520
Over Panel Side Panel
Connecting Patch with Pivot



OPF-2 STD SSS ₹ 2,145
Top Patch



OPF-3 STD SSS ₹ 2,145
Bottom Patch



OPF-4 STD SSS ₹ 3,245
Wall Mounted Over Panel
Patch with Pivot



OPF-610 STD SSS ₹ 3,025
Over Panel Side Panel
Connector



OPF-610 R/L STD SSS ₹ 4,125
Triple Glass Connector
with Fin (Right / Left)



OPF-610 ST STD SSS ₹ 2,750
Over Panel Side Panel Connector
with Stopper (One Side Opening
Door)



OPF-620 STD SSS ₹ 3,355
Quadruple Connector



OPF-620 F STD SSS ₹ 4,180
Quadruple Connector
with Fin



OPF-630 F STD SSS ₹ 4,015
Double Glass Connector
with Fin Fitting Inside



OPF-640 STD SSS ₹ 1,375
Wall to Glass Clamping Patch



OPF-640E STD SSS ₹ 1,122
Wall to Glass Clamping Patch



OPF-650 AA STD SSS ₹ 1,265
Wall to Glass Clamping Patch



OPF-650 STD SSS ₹ 1,650
Glass to Glass Connecting
Patch to Wall/Ceiling



OPF-660 STD SSS ₹ 1,760
Double Glass Connector



OPF-41 R/L STD SSS ₹ 5,555
Over Panel Side Panel
Connector with Fin
(Right / Left)



OPF-51 STD SSS ₹ 8,360
Over Panel Connector for
Back to Back Doors



OFS-ACC-GDP SSS ₹ 440
OFS-ACC-GDP PSS ₹ 446
Top Pivot for Patch/Point
Fitting Doors

STAINLESS STEEL PATCH FITTINGS

Solid Stainless Steel Patch Fittings in SS 304 grade



OSSPF-1 STD SSS ₹ 4,015
Over Panel Patch With Pivot



OSSPF-2 STD SSS ₹ 2,588
Top Patch



OSSPF-3 STD SSS ₹ 2,588
Bottom Patch



OSSPF-4 STD SSS ₹ 3,520
Wall Mounted Over Panel Patch with Pivot



OSSPF-GDP STD SSS ₹ 495
Top Pivot For SS Patch Fitting



OSSPF-610 STD SSS ₹ 3,355
Over Panel Side Panel Connector



OSSPL-1 STD SSS ₹ 6,268
Patch Lock



OSSPF-41 L (Left) SSS ₹ 8,625
Over Panel Side Panel Patch With Pivot Pin & Fin Attachment



OSSPF-41 R (Right) SSS ₹ 8,625
Over Panel Side Panel Patch With Pivot Pin & Fin Attachment



OSSPF-51 SSS ₹ 11,385
Double Pivot Patch For Back To Back Door With Fin

PREMIUM PATCH FITTINGS



Finish : SSS
SS-316

S Series
Premium Collection of Architectural Hardware



OPF-1S STD SSS ₹ 4,180
Over Panel Side Panel Connecting Patch with Pivot



OPF-2S STD SSS ₹ 2,640
Top Patch



OPF-3S STD SSS ₹ 2,640
Bottom Patch



OPF-4S STD SSS ₹ 3,960
Over Panel Patch Secured on to the Sidewall with Pivot



OPF-610S STD SSS ₹ 3,740
Over Panel Side Panel Connector



OPL-1S STD SSS ₹ 4,180
Corner Patch Lock with Strike Plate



OFS-ACC-GDP-S STD SSS ₹ 506
Top Pivot

PATCH FITTINGS

Finish : SSS



OPL-1E STD SSS ₹ 2,805
Corner Patch Lock



OPF-2E STD SSS ₹ 1,760
Top Patch



OPF-3E STD SSS ₹ 1,760
Bottom Patch



OFS-ACC-GDP-E SSS ₹ 314

PATCH LOCKS

Finish : PSS & SSS

Key Outside & Knob Inside
Glass to Glass Application



Strike Box

Lock



Front Side

Back Side

OPL-4A/4B-K2N STD SSS ₹ 4,070
Patch Locks with strike box
NO Cutout required

Key Outside & Knob Inside
Glass to Wall Application



Strike Plate

Lock



Front Side

Back Side

OPL-4A/S-K2N STD SSS ₹ 2,970
Patch Locks with strike plate
NO Cutout required



OPL-1 STD SS ₹ 3,355
Corner Patch Lock with
Strike Plate



₹ 2,090

OPL-2B STD SS
Centre Patch Lock
& Strike Box



₹ 4,235

OPL-2A STD SS



₹ 1,815

OPL-3A STD SS
Thumb Turn Lock



₹ 1,540

OPL-3B STD SS
Strike Box for OPL-3A



₹ 2,145

OPL-4A-N-S STD SSS
Glass Door Lock with
Strike plate
NO Cutout required



₹ 2,915

OPL-4A/4B-N STD SS
Glass Door Lock with
Strike Box
NO Cutout required

BLACK MATT PATCH FITTINGS

Finish : Black Matt



OPF-2 STD BM ₹ 2,467
Top Patch



OPF-3 STD BM ₹ 2,467
Bottom Patch



OPL-1 STD BM ₹ 3,858
Corner Patch Lock with
Strike Plate



OFS-ACC-GDP STD BM ₹ 506
Top Pivot for Patch
Fitting Doors

DESIGNER SERIES

Finish : SSS



₹ 14,850

OSSPL-ML-111 STD SSS*
Glass Door Lock With Latch Bolt, Dead Bolt & Strike Plate



₹ 20,020

OSSPL-ML-111-G STD SSS*
Glass Door Lock With Latch Bolt, Dead Bolt & Strike Box



₹ 14,030

OSSPL-SDL-111-G STD SSS*
Sliding Door Lock With Claw Type Dead Bolt & Strike Box

Above locks are for single side door opening and not recommended to be used with floor spring



₹ 7,946

OSSPL-DL-111 STD SSS*
Glass Door Lock With Dead Bolt & Strike Plate



₹ 10,747

OSSPL-DL-111-G STD SSS *
Glass Door Lock With Dead Bolt & Strike Box

***Available in Cylinder Options:**

K2K-C (Key to Key Computerised Cylinder) for OMC-11
K2N-C (Key to Knob Computerised Cylinder) for OMC-11

K2N-N (Key to Knob Normal Cylinder) for OMC-22
K2K-N (Key to Key Normal Cylinder) for OMC-22

MAGNETIC STRIKE LOCKS
FOR FRAMELESS GLASS DOORS



Finish : SSS



OZ-MGL-33S Series

Rectangular Glass Door Lock With Magnetic Strike Plate



Finish: SSS

Optional accessories:



OZ-MGL-33S-SB2-A STD SSS ₹ 10,235
OZ-MGL-33S-SB2-B STD SSS ₹ 9,790

Strike Box for Glass to Glass Application



OZ-MGL-33S-SP2 STD SSS ₹ 1,540

Strike Plate for Magnetic Rectangular Glass Door Lock for Glass to Wall Application

For Product Code and MRP refer table on next page*

***How to order OZ-MGL-33S**

Product Code	Description	Pic Reference-DIN Outside View	Compatible Strike Box
<p style="text-align: right;">₹ 10,235</p> <p>OZ-MGL-33S-SB2-R Std</p>	Inward-key to knob for RH opening	<p>Right Hand inward (DIN)</p>	OZ-MGL-33S-SB2-A STD SSS
<p style="text-align: right;">₹ 10,235</p> <p>OZ-MGL-33S-SB2-R Std</p>	Outward-key to knob for RH opening	<p>Right Hand Outward (DIN)</p>	OZ-MGL-33S-SB2-B STD SSS
<p style="text-align: right;">₹ 9,790</p> <p>OZ-MGL-33S-SB2-L Std</p>	Inward-key to knob for LH opening	<p>Left Hand inward (DIN)</p>	OZ-MGL-33S-SB2-B STD SSS
<p style="text-align: right;">₹ 9,790</p> <p>OZ-MGL-33S-SB2-L Std</p>	Outward-key to knob for LH opening	<p>Left Hand outward (DIN)</p>	OZ-MGL-33S-SB2-A STD SSS
<p style="text-align: right;">₹ 10,235</p> <p>OZ-MGL-33S-SB2-R Std</p>	Inward-key to knob for RH opening	<p>Right Hand inward (DIN)</p>	OZ-MGL-33S-SB2-A STD SSS
<p style="text-align: right;">₹ 10,235</p> <p>OZ-MGL-33S-SB2-R Std</p>	Outward-key to knob for RH opening	<p>Right Hand outward (DIN)</p>	OZ-MGL-33S-SB2-B STD SSS
<p style="text-align: right;">₹ 9,790</p> <p>OZ-MGL-33S-SB2-L Std SSS</p>	Inward-key to knob for LH opening	<p>Left Hand inward (DIN)</p>	OZ-MGL-33S-SB2-B STD SSS
<p style="text-align: right;">₹ 9,790</p> <p>OZ-MGL-33S-SB2-L Std SSS</p>	Outward-key to knob for LH opening	<p>Left Hand inward (DIN)</p>	OZ-MGL-33S-SB2-A STD SSS

MAGNETIC STRIKE LOCKS



Finish : SSS & Black Matt



FOR FRAMELESS GLASS DOORS

OZ-MGL-11S Series

Square Glass door Lock with Magnetic Strike Plate

For Product Code and MRP refer table on next page*



Finish: SSS

₹ 7,260



Finish: Black Matt

₹ 8,349

FOR BATHROOM FRAMELESS GLASS DOORS

OZ-MGL-22S Series

Square Bathroom Glass Door Lock with Magnetic Strike Plate (With WC Indicator)

For Product Code and MRP refer table on next page*



Finish: SSS

₹ 8,965



Finish: Black Matt

₹ 10,310

Optional accessories for OZ-MGL-11S Series and OZ-MGL-22S Series



₹ 4,070

OZ-MGL-11/22 S-SB1 STD SSS
Strike Box for Glass to Glass Application
Finish: SSS



₹ 1,265

OZ-MGL-11/22 S-SP1 STD SSS
Strike Plate for Glass to Wall Application
Finish: SSS



₹ 4,681

OZ-MGL-11/22 S-SB1 STD BM
Strike Box for Glass to Glass Application
Finish: Black Matt



₹ 1,455

OZ-MGL-11/22 S-SP1 STD BM
Strike Plate for Glass to Wall Application
Finish: Black Matt

***How to order OZ-MGL-22S / OZ-MGL-11S**

Product Code	Description	PLC Reference-DIN Outside View	
OZ-MGL-22S-I STD SSS OZ-MGL-22S-I STD BM SSS ₹ 9,680 BM ₹ 11,132	Inward-One side knob other side Coin Slot for RH/LH opening	Left Hand Inward (DIN) 	Right Hand Inward (DIN)
OZ-MGL-11S-I-K2N Std SSS OZ-MGL-11S-I-K2N Std BM SSS ₹ 10,340 BM ₹ 11,891	Inward-One side knob other side Coin Slot for RH/LH opening		
OZ-MGL-22S-O STD SSS OZ-MGL-22S-O STD BM SSS ₹ 9,680 BM ₹ 11,132	Outward-One side knob other side Coin Slot for RH/LH opening	Left Hand Outward (DIN) 	Right Hand Outward (DIN)
OZ-MGL-11S-O-K2N Std SSS OZ-MGL-11S-O-K2N Std BM SSS ₹ 10,340 BM ₹ 11,891	Outward-One side knob other side Coin Slot for RH/LH opening		
OZ-MGL-11S-K2K Std SSS OZ-MGL-11S-K2K Std BM SSS ₹ 10,340 BM ₹ 11,891		Universal	

PIVOT HINGES FOR SWING GLASS DOORS



Finish : SSS **S Series**
Premium Collection of
Architectural Hardware

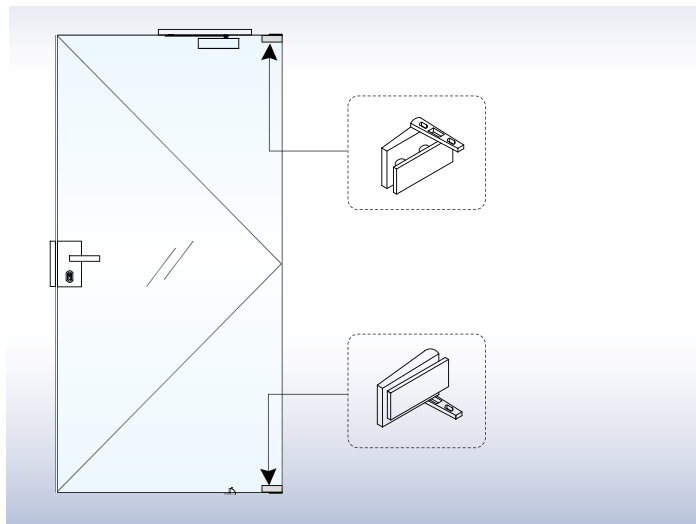

Features:

- Easy installation
- Horizontal adjustment: -/+3mm
- Vertical adjustment: 8-16mm
- Non-handed design

Specifications:

- For single/double swing door
- SS 304 grade material
- Push open at any position

Glass Thickness
08-10mm

Door Width
1000mm

60Kg
Weight Carrying
Capacity

TOP

BOTTOM



OZ-PGDH STD SSS ₹ 3,850
Pivot Hinge Set
Finish: SSS

TOP

BOTTOM



OZ-PGDH STD BM ₹ 4,428
Pivot Hinge Set
Finish: Black Matt

HYDRAULIC DOOR HINGES



Finish : SSS



Suitable for Interior Application

High Quality Spring | Smooth & Soft Closing Function | Elegant Design



Features:

- Spring loaded hydraulic hinges
- 90° hold open and no hold open options available
- Adjustable opening & closing speed

Specifications

- Double action door hinge
- Suitable for door size: 1000 x 2200mm
- Maximum glass thickness: 8 - 12mm
- Maximum door weight: 100 Kg (220Lbs) - Each Pair
- Maximum closing force: 4-8Nm
- Opening angle: 90° (Double Action)
- Material: SS 304



Closing & Latching Speed Adjustment Valve



OZ-DH-H1 STD SSS ₹ 22,540
Wall to Glass Hydraulic Hinges



OZ-DH-H2 STD SSS ₹ 26,620
Glass To Glass Hydraulic Hinges

PARTITION DOOR HINGES

For 10mm Glass

Finish : SSS

SS-304



OGC-DH-SC-1 STD SSS ₹ 12,650
Wall To Glass Hinge 90°
Spring Loaded
(supplied in pair)



OGC-DH-SC-2 STD SSS ₹ 15,950
Glass To Glass Hinge 180°
Spring Loaded
(supplied in pair)



OGC-DH-SC-4 STD SSS ₹ 14,190
Glass To Glass Hinge 90°
Spring Loaded
(supplied in pair)

THE ORIGINAL SELF CLOSING PATCH FITTING Finish : SSS & BLACK MATT

- Ambient temperature: -20°C to +50°C
- Quick and easy installation
- Door Weight Capacity: Upto **100kg**
- Finish: SSS



OCFH-100 STD SSS ₹ 14,410

- Max door width: 950mm
- Suitable door thickness: 8-12mm
- Tested as per: EN1154
- Ideal for Internal Doors
(Also available in gold matt)

OCFH-100 STD BM ₹ 16,570

- Max door width: 950mm
- Suitable door thickness: 8-12mm
- Tested as per: EN1154
- Ideal for Internal Doors

• For External Doors



OCFH-105 STD SSS ₹ 18,150

- Max door width: 1250mm
- Suitable door thickness: 10-15mm
- Tested as per: EN1154
- Ideal for External Doors

• Power Adjustable



OCFH-135 STD SSS ₹ 19,690

- Max door width: 1250mm
- Suitable door thickness: 10-15mm
- Ideal for Internal & External Doors

• Power Adjustable



OCFH-135 STD BM ₹ 22,640

- Max door width: 1250mm
- Suitable door thickness: 10-15mm
- Ideal for Internal & External Doors



OPF-1 PLUS STD SSS ₹ 3,960

Top Patch with Big Cover
(Same Size of OCFH-100)



OPF-2 PLUS STD SSS ₹ 3,190

Top Patch with Big Cover
(Same Size of OCFH-100)
(Also available in gold matt)



OPF-2 PLUS BM ₹ 3,669

Top Patch with Big Cover
(Same Size of OCFH-100)

THE ORIGINAL SELF CLOSING PATCH FITTING

with enhanced finish & superior quality



Finish : SSS & Black Matt



Specification:

- Quick and easy installation with just 4 fasteners
- EN-3 for interior & exterior applications
- Suitable door weight: Max 100kg.
- Suitable door width: 750-1000mm
- Suitable door thickness: 8-12mm
- Maximum opening 150° and controlled 135°
- Durability-500,000 Cycles tested
- Ambient temperature: -20°C to +50°C

Features:

- Cover & base plate in high grade Stainless Steel 316
- Corrosion resistant
- 3 years warranty
- Compliant with EN 1154 standard



OCFH-100S STD SSS ₹ 15,950
Finish: SSS



OCFH-100S STD BM ₹ 18,340
Finish: Black Matt



TOP PATCH FOR OCFH-100S

Finish : SSS & Black Matt

Specifications

- 1mm thick cover plate in high grade Stainless Steel 316
- Corrosion resistant
- Compatible with Ozone OFS-ACC-GDP-S and OPF-1 PLUS



OPF-2S PLUS STD SSS ₹ 3,960
Finish: SSS



OPF-2S PLUS STD BM ₹ 4,555
Finish: Black Matt

TOP PIVOT FOR OCFH-100S

Finish : SSS & Black Matt

Specifications

- Top pivot with 15mm diameter pin
- Wear-resistant SS 316 pivot pin
- Pivot held in overhead structure
- High grade SS 316 Patch fitting
- Finish: SSS



OFS-ACC-GDP-S STD SSS ₹ 506
Finish: SSS



OFS-ACC-GDP-S STD BM ₹ 506
Top Pivot for Patch
Fitting Doors

*T & C Apply

THE ORIGINAL SELF CLOSING PATCH FITTING GLASS DOOR SET



Finish : SSS



100kg
Weight Carrying Capacity

OCFH-100 Set STD SSS ₹ 17,380

Set Package Includes:

- OCFH-100 Std.(The Original Self Closing Patch Fitting)
- OPF-2 Plus (Top Patch)
- OFS-ACC-GDP (Pivot)

OFS-ACC-GDP

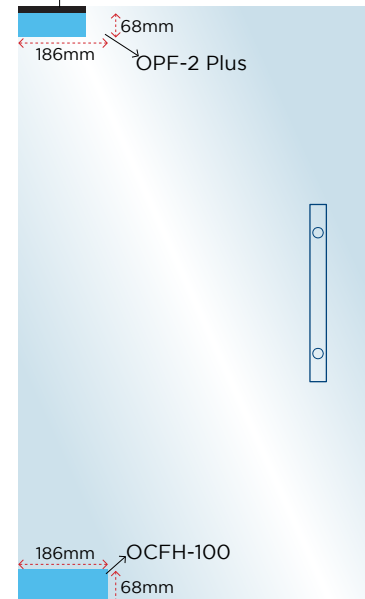

E Series



70kg
Weight Carrying Capacity

OCFH-70E Set STD SSS ₹ 10,890

Door weight upto 70kg

Set Package Includes:

- OCFH-70E STD SSS (The Original Self Closing Patch Fitting)
- OPF-2E (Top Patch)
- OFS-ACC-GDP-E (Pivot)

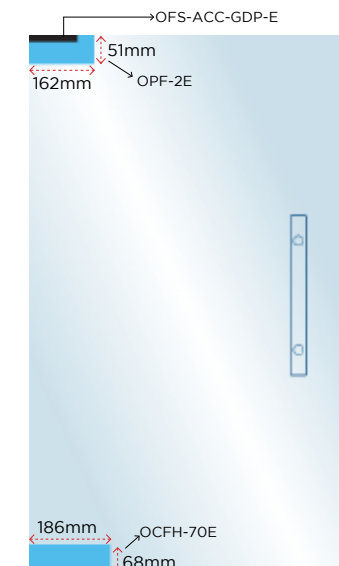

Note:-Same Cutout as Standard OCFH-100

GLASS WEDGE SYSTEM

Finish : SSS & AN

Wall Connecting Profiles for Fixed Glasses



Available with shoe moulding style.

OZONE GLASS WEDGE SYSTEM is a dry mount system which provides the installer with a cleaner, simpler method of setting tempered glass panels.

Features:

- Can be applied on ceiling, floor & wall
- Available in lengths of 2 meter or 3 meter
- Do not require any glass cutout
- End cap for better aesthetics



OGL-PR-11 2 Mtrs SSS ₹ 5,060
OGL-PR-11 3 Mtrs SSS ₹ 7,040
 Glass Wedge System
 Finish: Anodised & SSS

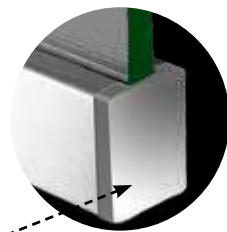

OGL-PR-11-Cap STD STD
 End Cap



OGL-PR-22 3 Mtr SSS ₹ 4,050
OGL-PR-22 3 Mtr AN ₹ 3,700
 Glass Wedge System
 Finish: SSS & Anodised

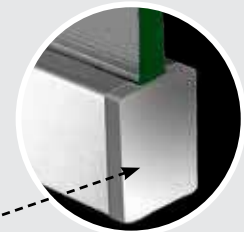

OGL-PR-22-EC STD STD
 End Cap

How to order OGL-PR-22

Kindly order equal length of OZ-EP-DM-44 & the other EPDM Black as per your glass thickness

OGL-PR-22 EPDM GASKET				
Product Code	Glass Thk	Image	Product Code	Image
OZ-EP-DM-11 Black ₹ 53	8 mm		OZ-EP-DM-44 STD Black	
OZ-EP-DM-22 Black ₹ 52	10 mm			
OZ-EP-DM-33 Black ₹ 29	12 mm			

GLASS DOOR HANDLES

Material: Stainless Steel
Finish : SSS



₹ 16,720

OGHL-55 35x1500 SSS
Glass Door Handle with locking function

Hole Dia	
14mm on attachment point, 22 mm for lock point	

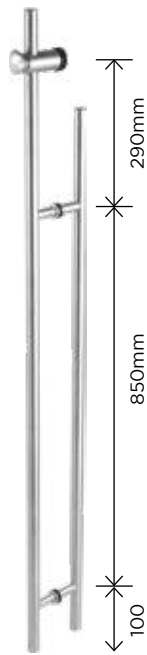

₹ 16,390

OGHL-55-25x1340 SSS
Glass Door Handle with locking function

Hole Dia	
16mm on attachment point, 35 mm for lock point	



₹ 14,190

OGH-661-38x1800 SSS
Glass Door Handle

CTC	1300mm
Hole Dia	12mm



₹ 10,780

OGH-662-38x1000 SSS
Glass Door Handle

CTC	600mm
Hole Dia	12mm



₹ 8,140

OGH-663-25x35x600 SSS
Glass Door Handle

CTC	400mm
Hole Dia	12mm

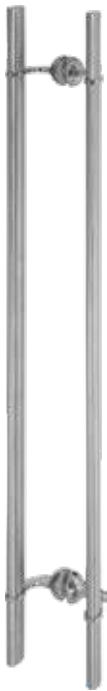

₹ 11,770

OGH-664-20x40x1200 SSS
Glass Door Handle

CTC	1000mm
Hole Dia	12mm



40x10x400 SSS	₹ 5,060
40x10x600 SSS	₹ 7,810
40x10x1200 SSS	₹ 10,560

OGH-551-ED -40x10x400 SSS
OGH-551-ED -40x10x600 SSS
OGH-551-ED -40x20x1200 SSS
Glass Door Handle

CTC	250mm	450mm	900mm
Hole Dia	12mm	12mm	12mm



40x10x400 SSS	₹ 4,730
40x10x600 SSS	₹ 5,280

OGH-552-ED -40x10x450 SSS
OGH-552-ED -40x10x600 SSS
Glass Door Handle

CTC	298mm	450mm
Hole Dia	12mm	12mm



20x40x400	₹ 3,190
20x40x800	₹ 5,170

OGH-554-ED -20x40x400 SSS
OGH-554-ED -20x40x800 SSS
Glass Door Handle

CTC	380mm	780mm
Hole Dia	12mm	12mm

GLASS DOOR HANDLES

Material: Stainless Steel
Finish : SSS, PSS & Black Matt



S Series
Premium Collection of Architectural Hardware



OGH-11			
D Type Handle Available in SSS Finish			
Sizes	MRP	CTC	Hole Dia
25mm x 325mm	₹ 2,475	300mm	12mm
25mm x 450mm	₹ 2,695	425mm	12mm
32mm x 600mm	₹ 3,355	568mm	12mm

OGH-11			
D Type Handle Available in PSS/SSS Finish			
Sizes	MRP	CTC	Hole Dia
25mm x 325mm	₹ 2,475	300mm	12mm
25mm x 450mm	₹ 2,695	425mm	12mm
32mm x 600mm	₹ 3,355	568mm	12mm

OGH-11S			
D Type Handle Available in SSS Finish			
Sizes	MRP	CTC	Hole Dia
25mm x 325mm	₹ 3,025	300mm	12mm
25mm x 450mm	₹ 3,393	425mm	12mm
32mm x 600mm	₹ 4,070	568mm	12mm

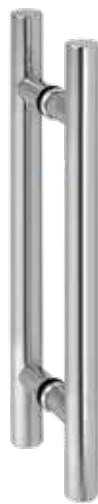

S Series
Premium Collection of Architectural Hardware

OGH-55		
H Type Handle Available in BM Finish		
Size	CTC	Hole Dia
32x457mm	305mm	12mm

₹ 3,795

OGH-55			
H Type Handle Available in SSS Finish			
Sizes	MRP	CTC	Hole Dia
25x325mm	₹ 2,200	240mm	12mm
25x350mm	₹ 2,420	240mm	12mm
25x450mm	₹ 2,530	308mm	12mm
25x600mm	₹ 2,640	455mm	12mm
25x1100mm	₹ 4,840	900mm	12mm
32x457mm	₹ 2,640	305mm	12mm
32x600mm	₹ 2,750	480mm	12mm
32x900mm	₹ 3,520	700mm	12mm

OGH-55			
H Type Handle Available in PSS/SSS Finish			
Sizes	MRP	CTC	Hole Dia
25mm x 325mm	₹ 2,255	240mm	12mm
25mm x 600mm	₹ 2,695	455mm	12mm
32mm x 457mm	₹ 2,750	305mm	12mm
32mm x 600mm	₹ 2,860	480mm	12mm

OGH-55S			
H Type Handle Available in SSS Finish			
Sizes	MRP	CTC	Hole Dia
32mm x 457mm	₹ 3,105	305mm	12mm
32mm x 600mm	₹ 3,393	480mm	12mm

Grade: SS 202			
OGH-55-E			
E Series			
Sizes	MRP	CTC	Hole Dia
19mm x 305mm	₹ 1,760	212mm	12mm
32mm x 457mm	₹ 1,815	305mm	12mm

**GLASS DOOR HANDLES IN STAINLESS STEEL
AND WOOD FINISH COMBINATION**



Material: Stainless Steel
Finish : SSS



Specifications:

- Glass hole dia 12mm
- Gaskets to prevent the contact between glass and metal
- Grub screws kept out of sight
- Material -SS304 grade

Features:

- Wood design aesthetics
- SSS with wooden finish combination
- Durable material
- Design variants available



OGH-11W 25x325MM WSS			
Sizes	MRP	CTC	Hole Dia
25mm x325mm	₹ 3,168	300mm	12mm



OGH-88 32x480MM WSS			
Sizes	MRP	CTC	Hole Dia
32mm x480mm	₹ 4,543	450mm	12mm



OGH-55 32x457MM WSS			
Sizes	MRP	CTC	Hole Dia
32mm x457mm	₹ 3,300	305mm	12mm

DOUBLE ACTION 3-WAY 'T' SHOWER HINGES



Finish : PSS



Specification:

- Maximum Glass Thickness: 8 & 10mm
- Maximum door width: 700mm
- Opening: inward (recommended) and outward
- Self-closing function activates once door reaches 30°
- Material: SS 304
- Finish: PSS



OSSH-22T-ED PSS ₹ 7,755

Double Action 3-Way 'T' Shower Hinges

SHOWER HINGES FOR 6/8MM GLASS



Finish : PSS



OSSH-1-ED 6/8mm PSS ₹ 1,440

Wall to Glass Hinge



OSSH-2-ED 6/8mm PSS ₹ 2,270

Glass to Glass Hinge 180°

Specification:

- Suitable for 6/8mm glass
- Ideal for residential showers & retail displays
- SS-304 grade material
- PSS finish



OSSH-3-ED 6/8mm PSS ₹ 2,420

Glass to Glass Hinge 135°



OSSH-4-ED 6/8mm PSS ₹ 2,550

Glass to Glass Hinge 90°



OSSH-5-ED 6/8mm PSS ₹ 1,110

Wall to Glass Bracket (Fixed Glass)

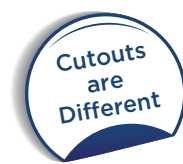

Suitable for
6/8mm glass

SHOWER HINGES

Finish: CP, SN, SSS & PSS



OSH-1 STD CP ₹ 3,289
OSH-1 STD SN ₹ 3,300

Wall to Glass Hinge for 8-10mm Glass



OSH-2 STD CP ₹ 4,906
OSH-2 STD SN ₹ 4,950

Glass to Glass Hinge 180° for 8-10mm Glass



OSH-3 STD CP ₹ 5,313
OSH-3 STD SN ₹ 5,335

Glass to Glass Hinge 135° for 8-10mm Glass



OSH-4 STD CP ₹ 5,258
OSH-4 STD SN ₹ 5,280

Glass to Glass Hinge 90° for 8-10mm Glass



OSH-5 STD CP ₹ 2,827
OSH-5 STD SN ₹ 2,860

Wall to Glass Bracket for 8-10mm Glass



OGC-444 STD SSS ₹ 1,188
OGC-444 STD PSS ₹ 1,155

Wall to Glass Connector 90° for 8-10mm Glass

OPTIONAL FITTINGS



OSH-66 CP ₹ 3,025
OSH-66 SN ₹ 3,025

Wall to Glass Hinge for 6-8mm Glass



OSH-77 CP ₹ 4,015
OSH-77 SN ₹ 4,015

Glass to Glass Hinge for 6-8mm Glass (Single Side Opening)



OSH-OFS-1 STD CP ₹ 3,058
OSH-OFS-1 STD SN ₹ 3,080

Wall to Glass Offset Hinge for 8-10mm Glass

Design Regd.

Design Regd.

Design Regd.

Design Regd.

Design Regd.



OGC-1A STD SSS ₹ 484
OGC-1A STD PSS ₹ 479

Floor/Wall to Glass Connector for 8-10mm Glass



OGC-2A STD SSS ₹ 677
OGC-2A STD PSS ₹ 677

Glass to Glass Connector 135° for 8-10mm Glass



OGC-3A STD SSS ₹ 699
OGC-3A STD PSS ₹ 682

Glass to Glass Connector 90° for 8-10mm Glass



OGC-4A STD SSS ₹ 666
OGC-4A STD PSS ₹ 666

Wall to Glass Connector 90° for 8-10mm Glass



OGC-5A STD SSS ₹ 677
OGC-5A STD PSS ₹ 666

Glass to Glass Connector 180° for 8-10mm Glass

SHOWER HINGES

Finish : PSS & SSS

Edge Series

Glass Thickness: 8-10mm



SSS ₹ 2,222
PSS ₹ 2,222

OSSH-11-ED STD SSS
OSSH-11-ED STD PSS
Wall to Glass Hinge



PSS ₹ 2,585

OSSH-OFS-11-ED STD SSS
OSSH-OFS-11-ED STD PSS
Off Set Mounted Side Hinge



SSS ₹ 3,498
PSS ₹ 3,498

OSSH-22-ED STD SSS
OSSH-22-ED STD PSS
Glass to Glass Hinge 180°



SSS ₹ 3,740
PSS ₹ 3,729

OSSH-33-ED STD SSS
OSSH-33-ED STD PSS
Glass to Glass Hinge 135°



SSS ₹ 3,927
PSS ₹ 3,927

OSSH-44-ED STD SSS
OSSH-44-ED STD PSS
Glass to Glass Hinge 90°

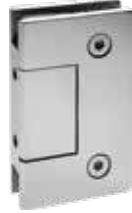

SSS ₹ 2,134
PSS ₹ 2,134

OSSH-55-ED STD SSS
OSSH-55-ED STD PSS
Wall to Glass Bracket (Fixed Glass)

GLASS CONNECTORS

Finish : SSS & PSS

Glass Thickness: 8-10mm

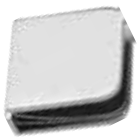

OGC-1 STD SSS ₹ 490
OGC-1 STD PSS ₹ 490

Glass Connector for
Wall / Floor Mounting



OGC-2 STD SSS ₹ 726
OGC-2 STD PSS ₹ 726

Glass to Glass
Connector 135°



OGC-3 STD SSS ₹ 748
OGC-3 STD PSS ₹ 748

Glass to Glass
Connector 90°



OGC-4 STD SSS ₹ 699
OGC-4 STD PSS ₹ 699

Wall to Glass Connector 90°
(Also available in
gold plated)



OGC-5 STD SSS ₹ 726
OGC-5 STD PSS ₹ 710

Glass to Glass
Connector 180°

E Series



OGC-1E STD PSS ₹ 374

Glass Connector for
Wall / Floor Mounting



OGC-2E STD PSS ₹ 512

Glass to Glass
Connector 135°



OGC-3E STD PSS ₹ 534

Glass to Glass
Connector 90°



OGC-4E STD PSS ₹ 490

Wall to Glass
Connector 90°



OGC-5E STD PSS ₹ 512

Glass to Glass
Connector 180°

Edge Series



SSS ₹ 880
PSS ₹ 880

OGC-111-ED STD SSS
OGC-111-ED STD PSS
Wall / Floor to
Glass Connector



PSS ₹ 1,254

OGC-222-ED STD PSS
Glass to Glass
Connector 135°



PSS ₹ 1,144

OGC-333-ED STD SSS
OGC-333-ED STD PSS
Glass to Glass
Connector 90°



SSS ₹ 913
PSS ₹ 913

OGC-444-ED STD SSS
OGC-444-ED STD PSS
Wall to Glass
Connector 90°



PSS ₹ 1,254

OGC-555-ED STD PSS
Glass to Glass
Connector 180°

SHOWER HINGES



Finish : Black Matt

Glass Thickness: 8-10mm



OSSH-11-ED STD BM ₹ 2,550
Wall to Glass Hinge



OSSH-22-ED STD BM ₹ 4,023
Glass to Glass Hinge 180°



OSSH-33-ED STD BM ₹ 4,288
Glass to Glass Hinge 135°



OSSH-44-ED STD BM ₹ 4,516
Glass to Glass Hinge 90°



OSSH-55-ED STD BM ₹ 2,454
Wall to Glass Fixed Bracket

GLASS CONNECTORS



Finish : Black Matt

Glass Thickness: 8-10mm



OGC-111-ED STD BM ₹ 1,012
Wall to Glass Connector



OGC-222-ED STD BM ₹ 1,442
Glass to Glass Connector 135°



OGC-333-ED STD BM ₹ 1,316
Glass to Glass Connector 90°



OGC-444-ED STD BM ₹ 1,050
Wall to Glass Connector 90°



OGC-555-ED STD BM ₹ 1,442
Glass to Glass Connector 180°



GLASS CONNECTORS are Compatible with all Shower Hinges of S-Series

PREMIUM SHOWER HINGES



Finish : CP & Black Matt

S Series
Premium Collection of Architectural Hardware



- Seamless Design
- Water Tight Fitting Ensures NO Water Leakage
- Min. Gap
- Snapfit Cover Cap
- Suitable for glass thickness: 8-10mm

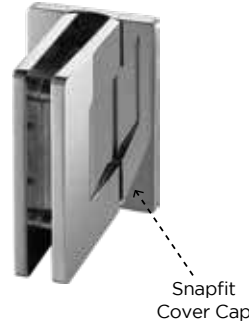

OSH-1S STD CP ₹ 3,617
Wall to Glass Hinge
(Also available in rose gold)



OSH-2S STD CP ₹ 4,744
Glass to Glass 180° Hinge
(Also available in rose gold)



CP ₹ 4,169
OSH-OFS-1S STD CP
Wall to Glass off-set Hinge



BM ₹ 4,794
OSH-OFS-1S STD BM
Wall to Glass off-set Hinge
Finish: Black Matt



CP ₹ 2,915
OSH-5S STD CP
Wall to Glass Connector
(Also available in rose gold)

TOWEL BAR WITH HANDLES

Finish : PSS, SSS & Black Matt

S Series
Premium Collection of Architectural Hardware



OGH-TB-1S STD PSS ₹ 4,455
Flattened Towel Bar with Knob
Finish: PSS



OGH-TB-1 STD BM ₹ 3,099
Towel Bar with Handle (Ø19 mm)
Finish: Black Matt

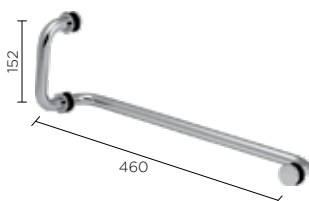

OGH-TB 1 STD SSS ₹ 2,695
OGH-TB 1 STD PSS ₹ 2,695
Towel Bar with Handle (Ø19 mm)

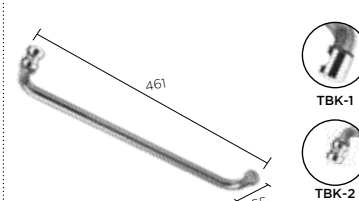

OGH-TBK-1 PSS ₹ 2,475
OGH-TBK-2 PSS ₹ 2,420
Towel Bar with Knob

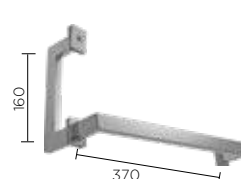

OGH-TB-ED STD PSS ₹ 2,703
Towel Bar with Handle



SSS ₹ 1,320
OGH-11 19x171 SSS
Shower Door Handle

SLIDING SHOWER SCREEN



- Maximum Door Weight: 50kg
- Maximum Door Width: 750mm
- Maximum Door Height: 2000mm
- Maximum Glass Thickness: 8, 10mm

OSSL.SYS.1E 2M CP ₹ 10,989
OSSL.SYS.1E 3M CP ₹ 14,630
 Wall to Wall System



OSSL.SYS.90.1E 1.65mx2 CP ₹ 19,895
 Corner Entry System



COMPONENT DETAILS

SLIDING SHOWER SCREEN ACCESSORIES		Wall to Wall System	Corner Entry System
	Ø35 Stainless Steel Knob Clamp Roller Finish: Polished or Satin Stainless Steel *Suits 8-10mm Glass Thickness	2 pcs.	4 pcs.
	Aluminium Top Track Finish: Polished or Satin Aluminium	2 meters Length	1.65 meter - 2 Length
	Stainless Steel Mounting Bracket (LH/RH) Finish: Polished or Satin Stainless Steel	1 Set (1 LH and 1 RH)	1 Set (1 LH and 1 RH)
	Nylon End Stopper with Catch Device	2 pcs.	4 pcs.
	Single-U Nylon Floor Guide	1 pc.	2 pcs.
	Track Corner Joint Finish: Polished or Satin Chrome (for Corner Entry System)	N.A.	1 pc.

OPTIONAL ACCESSORIES



₹ 858

ODK-2 STD PSS
Glass Door Knob



₹ 1,738

SL-HN-50 STD SSS
Sliding Door Handle



₹ 972

OPS-M3 STD
90° Magnetic Seal



₹ 270

OPS-9 STD
Offset Lip Seal



3Mt ₹ 1,342

OZGL-UPR-SS
Stainless Steel Channel
For 10 & 12mm Glass



SSS ₹ 699
PSS ₹ 699

OGC-4 STD SSS
OGC-4 STD PSS
Wall to Glass
Connector 90°

SLIDING DOOR SYSTEM - OSL-ED-SYS-11: for shower cubicles & internal doors



		How to Order (Available in kits only)	
Product Code (Only for Individual Product Order)	Product Image	OSL-ED-SYS-11 1.65 mtr Kit includes ₹ 15,950	OSL-ED-SYS-11 2 mtr Kit includes ₹ 17,050
SL-ED-11-A1 STD PSS Sliding Door Roller		02 Sets	02 Sets
SL-ED-11-A2 STD PSS Track to Glass Holder		02 pcs	02 pcs
SL-ED-11-A3 STD PSS Stopper		02 pcs	02 pcs
SL-ED-11-A4 STD PSS Floor Guide		01 pc	01 pc
OSSKH-1-ED STD PSS Wall to Track Connector		02 pcs	02 pcs
OSSKH-ACC-25T-ED 1.65Mtr PSS OSSKH-ACC-25T-ED 1.65Mtr BM Connector Track		01 pc	-
OSSKH-ACC-25T-ED 2Mtr PSS OSSKH-ACC-25T-ED 2Mtr BM Connector Track <i>(Please note that 2mt Track does not have Pre-drilled Holes for A2)</i>		-	01 pc

Optional Fitting for 90° Application



SL-ED-11-A6 STD PSS ₹ 1,892
Track to Glass Holder
Optional for 90° Application

SHOWER KNIGHT HEAD FITTINGS

Finish : PSS & SSS

<p>SSS ₹ 704 PSS ₹ 704</p> <p>OSKH-1 STD SSS OSKH-1 STD PSS Reinforcing Rod With Wall Connector (Also available in gold plated)</p>	<p>SSS ₹ 737 PSS ₹ 732</p> <p>OSKH-2 STD SSS OSKH-2 STD PSS Reinforcing Rod Support from Glass Through and Through (Also available in gold plated)</p>	<p>SSS ₹ 759 PSS ₹ 737</p> <p>OSKH-2A STD SSS OSKH-2A STD PSS Reinforcing Rod Support from Glass One Side Blind</p>	<p>SSS ₹ 957 PSS ₹ 957</p> <p>OSKH-3 STD SSS OSKH-3 STD PSS Reinforcing Rod Connector Universal</p>	
<p>2mtr SSS ₹ 1,656 2mtr PSS ₹ 1,876 3mtr SSS ₹ 2,365 3mtr PSS ₹ 2,739</p> <p>OSKH-ACC-19 2mtr SSS OSKH-ACC-19 2mtr PSS OSKH-ACC-19 3mtr SSS OSKH-ACC-19 3mtr PSS Reinforcing Rod 19mm Diameter (Also available in gold plated)</p>	<p>PSS ₹ 1,067</p> <p>OSKH-1C STD PSS Reinforcing Bars cum Glass Support Wall Bracket</p>	<p>PSS ₹ 1,326</p> <p>OSKH-3C STD PSS Pipe Connectors at any angle for Glass Stabilization</p>	<p>OSKH-T STD PSS ₹ 924 Reinforcement Bars for Adjoining Shower Cubicles</p>	

EDGE LINE KNIGHT HEAD FITTINGS

Finish : PSS, Black Matt & Rose Gold

<p>Design Regd.</p> <p>OSSKH-1-ED STD PSS ₹ 594 Wall to Track Connector</p>	<p>Design Regd.</p> <p>PSS ₹ 655</p> <p>OSSKH-2-ED STD PSS Track to Glass Connector</p>	<p>Design Regd.</p> <p>PSS ₹ 710</p> <p>OSSKH-3-ED STD PSS Glass to Track end Connector Track to Track 90° Connector</p>	<p>1.65mtr PSS ₹ 2,299 2mtr PSS ₹ 2,684</p> <p>OSSKH-ACC-25T-ED 1.65mtr PSS OSSKH-ACC-25T-ED 2mtr PSS Connector Track</p>
<p>Black Matt Finish</p> <p>BM ₹ 683</p> <p>OSSKH-1-ED STD BM Wall to Track Connector</p>	<p>New</p> <p>BM ₹ 750</p> <p>OSSKH-2-ED STD BM Track to Glass Connector</p>	<p>BM ₹ 820</p> <p>OSSKH-3-ED STD BM Glass to Track end Connector Track to Track 90° Connector</p>	<p>2mtr BM ₹ 3,087</p> <p>OSSKH-ACC-25T-ED 1.65mtr. BM OSSKH-ACC-25T-ED 2mtr. BM Connector Track</p>

Door Knobs

<p>ODK-1 STD PSS ₹ 853 Glass Door Knob</p>	<p>ODK-2 STD PSS ₹ 858 Glass Door Knob</p>
---	---

Plastic Profile

Finishes: **BM** **RG** **CS**

Available for 8, 10 & 12mm Glass
Standard Length - 2.2mt



OPS-1 STD ₹ 270
Wall Seal

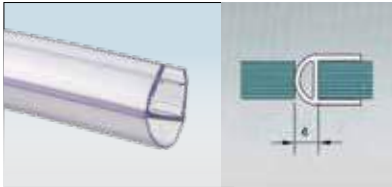

OPS-4 STD ₹ 270
Central 180° Weather Seal

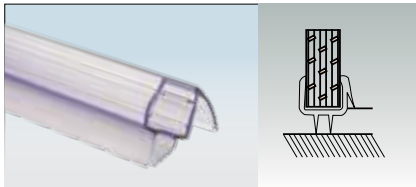

OPS-6 STD ₹ 270
Water Dispersional Seal

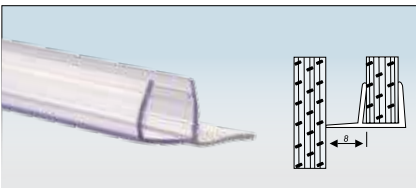

OPS-9 STD ₹ 270
Offset Lip Seal

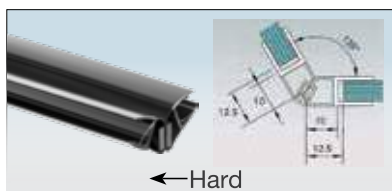

OPS-M2 10mm BM ₹ 1,192
135° Magnetic Seal

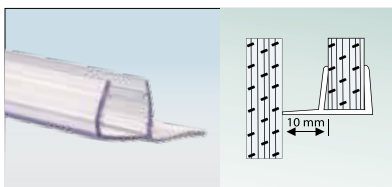

OPS-11 STD ₹ 270
Offset Lip Seal

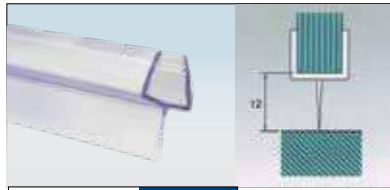

OPS-2 STD ₹ 270
Central Seal



OPS-4 10mm BM ₹ 311
Central 180° Weather Seal

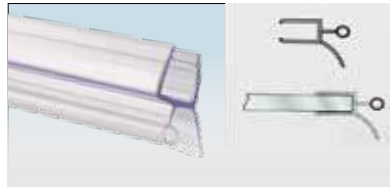

OPS-7 STD ₹ 270
Water Dispersional Seal



OPS-M1 10mm STD ₹ 1,037
180° Magnetic Seal

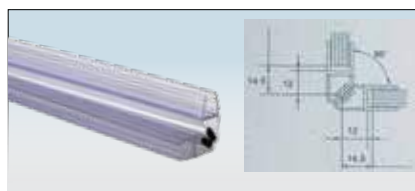

OPS-M3 8mm STD ₹ 972
90° Magnetic Seal

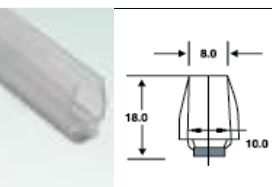

OPS-SL-BR-11 12mm STD ₹ 832
Brush Seal (Central)

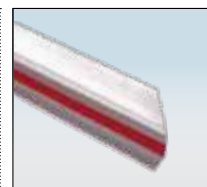

OPS-SL-11L 10ft Std
Offset Lip Seal

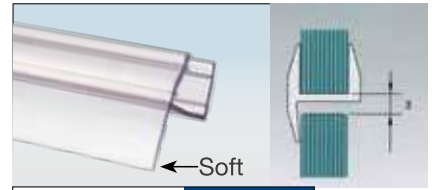

OPS-3 STD (Soft) ₹ 270
Central 180° Weather Seal

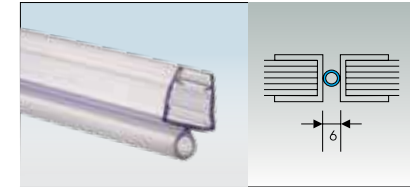

OPS-5 STD ₹ 270
Soft Nose Seal

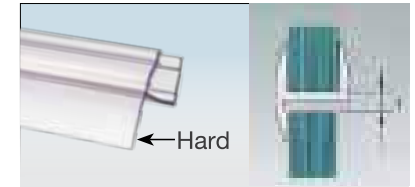

OPS-8 STD (Hard) ₹ 270
Central 180° Weather Seal

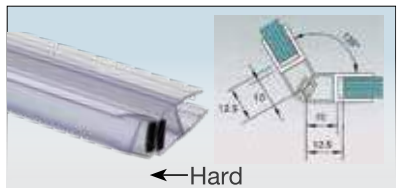

OPS-M2 8mm STD ₹ 972
135° Magnetic Seal

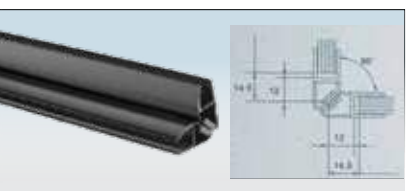

OPS-M3 10mm BM ₹ 1,192
90° Magnetic Seal

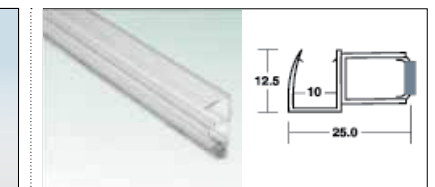

OZOM-SL-BR-22N-10ft 12m STD ₹ 832
Brush Seal (Sliding Doors)

₹ 378

SLIDING SYSTEM FOR FRAMELESS GLASS DOORS

Finish: SSS

Glass Thickness: 8-10mm



OZ-ESL-GL-11-60 STD STD ₹ 1,461
Sliding System Set W/O Track for Single Frameless Door of **60 Kg**



OZ-ESL-GL-11-80 STD STD ₹ 2,299
Sliding System Set W/O Track for Single Frameless Door of **80 Kg**



OZ-ESL-GL-11-100 STD STD ₹ 3,058
Sliding System Set W/O Track for Single Frameless Door of **100 Kg**



OZ-ESL-GL-11-150 STD STD ₹ 5,589
Sliding System Set W/O Track for Single Frameless Door of **150 Kg**



OZ-ESL-TRACK-E1 2mtr STD ₹ 950
OZ-ESL-TRACK-E1 4mtr STD ₹ 2,050
Top Track Suitable for ESL GL-11-60 & 80 (Available in 2mt & 4mt)



OZ-ESL-TRACK-E2 2mtr STD ₹ 2,050
OZ-ESL-TRACK-E2 4mtr STD ₹ 4,090
Top Track Suitable for ESL GL-11-120 & 200 (Available in 2mt & 4mt)

SLIDING DOOR SYSTEM - 44

Finish: SSS

Glass Thickness: 10-12mm



Product Code	Product Image	SL-44-A1 KIT STD SSS (Kit Includes) ₹ 7,645	Product Code	Product Image	SL-44-A2 KIT STD SSS (Kit Includes) ₹ 10,670
OZ-SL-44-A1 STD SSS Roller for Glass Door (40 Kg Wt)		01 Set	OZ-SL-44-A2 STD SSS Roller for Glass Door (80 Kg Wt)		01 Set
OZ-SL-44-A3 STD White Stopper		02 Pcs	OZ-SL-44-A3 STD White Stopper		02 Pcs
OSL-33-G Floor Guide		01 Pc	OSL-33-G Floor Guide		01 Pc

OTHER ACCESSORIES

As per Site requirement

 ₹ 314 OZ-SL-44-A4 STD BM Cover Plate for Track B1	 ₹ 957 OZ-SL-44-A5 STD SSS Wall to Track Fixer	 ₹ 616 OZ-SL-44-A6 STD SSS Glass to Track Fixer with Counter Sunk	 ₹ 512 OZ-SL-44-A7 L/R STD STD Curved Track Cover End Piece (L/R)
 ₹ 319 SL-44-A9 STD STD Wall to track connector	 ₹ 314 SL-44-A8 90 degree track connector		
 2mtr AN ₹ 3,950 4mtr AN ₹ 7,950 OZ-SL-44-B1 Track 2mtr STD AN OZ-SL-44-B1 Track 4mtr STD AN Aluminium Anodized Track for Sliding Door Panels	 2mtr AN ₹ 5,100 4mtr AN ₹ 10,400 OZ-SL-44-B2 Track 2mtr STD AN OZ-SL-44-B2 Track 4mtr STD AN Aluminium Anodized Track for Double Sliding Door Panels	 2mtr AN ₹ 4,800 4mtr AN ₹ 9,550 OZ-SL-44-B3 Track 2mtr STD AN OZ-SL-44-B3 Track 4mtr STD AN Aluminium Anodized Track for Sliding & Fixed Glass Door Panels	

PREMIUM MANUAL SLIDING SYSTEMS



Finish: SSS
Glass Thickness: 10-12mm



Item Codes With Soft Close	
OZSL-V-S-SYS Std SSS	₹ 26,730
OZSL-V-S-Track 2mtr SSS	₹ 16,500



Item Codes Without Soft Close	
OZSL-G-S-SYS Std SSS	₹ 21,230
OZSL-G-S-Track 2mtr SSS	₹ 16,500

Key Features:

- Soft closing single sliding glass door for internal applications
- Elegant and slim design can be mounted on glass, wall and ceiling
- Tested for 100,000 cycles, as per EN1527 standards
- Hydraulic soft closing bumper-Tested for 2,00,000 impact cycle



Specifications:

- Aluminium anodised top slim Track Size: 54x58mm
- Max. door weight: 40-80kgs/ 2 carriages
- Max. Glass Thickness: 10mm or 12mm
- Finish: SS or brushed clear
- Length: 2mtr (Standard) and 4mtr (Against order)



Optional Fittings:

- Glass Clamp-OZ-GV-A6 for mounting track on glass (06 pcs set)
- Side profile OZ-SL-ST for side fixed panel

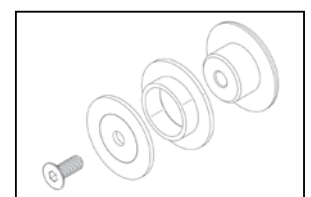

OZ-SL-ST 1.3mtr SSS ₹ 3,839

OZ-GV-A6 STD SSS ₹ 7,205
(06 pcs set)

Note: Heavy duty **80-150 kgs.** also available

TELESCOPIC GLASS SLIDING SYSTEMS



Finish : SSS & AN
Glass Thickness: 10-12mm



Ozone introduces the Glass Synchronized Manual Telescopic Sliding Door System to achieve maximum clear door opening space. Its door panels can be stacked on one side in-line with top track and require minimum parking space.

Its ideal applications are in residential and commercial interior spaces as internal partitioning system. For more details, send an enquiry at support@ozone-india.com

Specifications:

- Maximum Width of Panels-1000mm
- Maximum Weight of Panels-90Kg
- Maximum Thickness of Glass-10/12mm
- Available Track length-3mtr & 4mtr
- Finish: Aluminum Anodized



3 PANEL DOOR SLIDING SET:

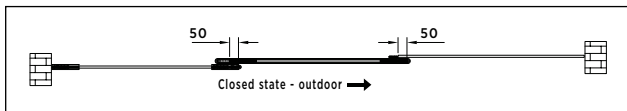

OSL-TG-03 R Std AN ₹ 22,660/set
Right Hand Opening

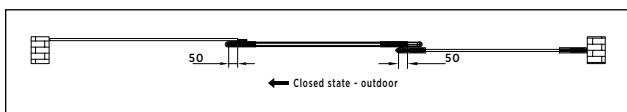

OSL-TG-03 L Std AN ₹ 23,690/set
Left Hand Opening

4 PANEL DOOR SLIDING SET:

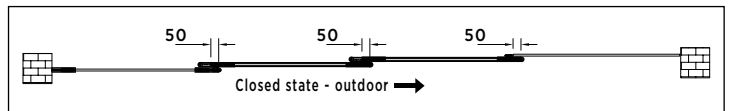

OSL-TG-04 R Std AN ₹ 36,110/set
Right Hand Opening

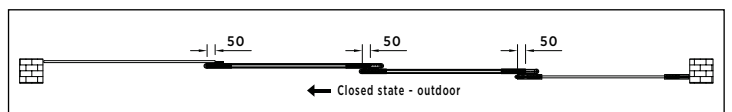

OSL-TG-04 L Std AN ₹ 36,110/set
Left Hand Opening

TOP TRACK & ACCESSORIES

3mtr AN ₹ 31,700/set

4mtr AN ₹ 42,900/set

OSL-TG-Track-ACC-3mtr AN
3mtr Track with other Accessories

OSL-TG-Track-ACC-4mtr AN
4mtr Track with other Accessories



Top U Channel-1Pc.



Top Track-2Pcs.



Bottom U Channel-1Pc.



Pelmet Cover-2Pcs.



SS Rope, 2mtr-1Pc.

Additional Accessories Required For OSL-TG-04 R/L (Four Panels)

Item Code for 3mtr. track (If clear opening at site is upto 3mtr)	Price	OR	Item Code for 4mtr. track (If clear opening at site is upto 4mtr)	Price
OSL-TGW-Track-3mtr AN (1pc)	₹ 7,450		OSL-TGW-Track-4mtr AN (1pc)	₹ 9,900
OSL-TGW-Rope-2mtr SS (1pc)	₹ 661		OSL-TGW-Rope-2mtr SS (1pc)	₹ 661

ALSO AVAILABLE FOR
WOODEN/FRAMED DOORS

**SLIDING GLASS DOOR LOCK WITH HANDLE
FOR CONVENIENT ACCESS**



Finish: SSS
Glass Thickness: 08-12mm



Specifications:

- Sliding glass door lock with handle
- Overall dimensions - 170 (L) X 70 (H) mm
- Lock with European cylinder
- Material - stainless steel
- Finish - brushed nickel plated

Features:

- Interchangeable for right & left hand
- Prevents direct contact of glass edge to the wall
- Door can be locked if fixed glass & sliding door panels are on inline*
- Lock can be adjusted for variable gap between fixed glass and sliding door with the help of spacer**

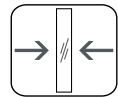

Glass Thickness
08-12mm

Sliding Glass Door Lock:



OSDL-11L-K2N Std SSS ₹ 8,682
OSDL-11R-K2N Std SSS ₹ 8,682

Key to Knob for door opening to left



OSDL-11-K2K Std SSS ₹ 8,682

Both side key option for universal door opening

Accessories:

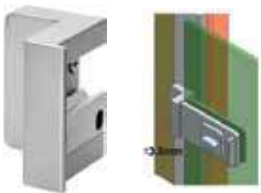

OSDL-11-SB1 STD SSS ₹ 2,640

Strike Box for Offset Wall/
Frame to Glass

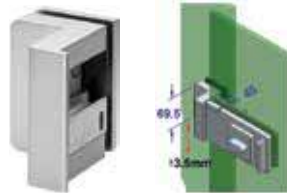

OSDL-11-SB2 STD SSS ₹ 2,760

Strike Box for Offset Glass
to Glass Application



OSDL-11ACC-SPC 5mm SSS ₹ 583**

OSDL-11ACC-SPC 10mm SSS ₹ 583
5/10mm Spacer for Strike Box

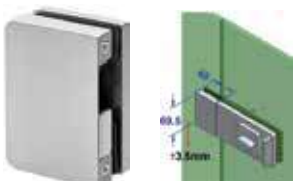

OSDL-11-SB STD SSS* ₹ 3,190

Strike Box for Inline Glass to
Glass Application

SLIDING DOOR HANDLES FOR FRAMELESS GLASS DOORS



Finish: SSS
Glass Thickness: 08-10mm



Specifications:

- Base material aluminium
- BRUSHED stainless steel finish

Features:

- Easy installation
- Easy access from inside & outside
- Increased opening space
- Universal

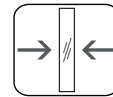

Front



Back

OZ-SL-HN-70 Std SSS ₹ 3,703
Sliding Door Handle

SLIDING DOOR HANDLES FOR GLASS DOORS



SL-HN-50 STD SSS ₹ 1,738
Sliding Door Handle



SL-HN-60 STD SSS ₹ 1,760
Sliding Door Handle

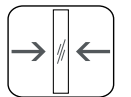

Glass Thickness
08-10mm

**CENTER GLASS SLIDING FOLDING SYSTEM
WITHOUT BOTTOM TRACK**



Finish: SSS
Glass Thickness: 10-12mm



Specifications:

- Sliding panel secured with integrated drop bolt
- End panel secured with bottom lock with key mechanism
- Central stacking that occupy min space in passage or lobby
- Two systems can be installed at both end to give wider opening passage
- System can be installed in various configurations
- Material SS 304 grade
- Finish satin stainless steel

Applications:

Interior & Exterior application in :

- Commercial Buildings, Residences, Hotels, Offices

Features:

- Nylon wheels with integrated bearings for quite & smooth running
- Panel height adjustable with roller
- Panels are connected with hinge
- Cover plate of hardware secured with grub screw

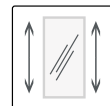

Panel Height
2500mm

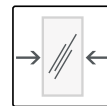

Panel Width
800mm



Fittings can be selected based on number of panels :



Folding Door Roller
SL-444-B10 ₹ 7,172



Glass to Glass Hinges
SL-444-B6 ₹ 6,050



Upper Fixing Clip
SL-444-B16 ₹ 4,455



Lower Fixing Clip
SL-444-B17 ₹ 4,334



Top Track, Aluminium Finish
SL-444-TT 3mtr ₹ 12,300
SL-444-TT 4mtr ₹ 16,100



Corner Patch Lock
SL-444-B-CL ₹ 6,325



Glass Door Bolt
SL-444-B-DB ₹ 4,950



Bolt Sleeve
SL-444-B-SLV ₹ 726



Strike Plate
SL-444-B-SP ₹ 473

SLIDING DOOR SYSTEM - 444

Finish : SSS & AN
Glass Thickness: 10-12mm

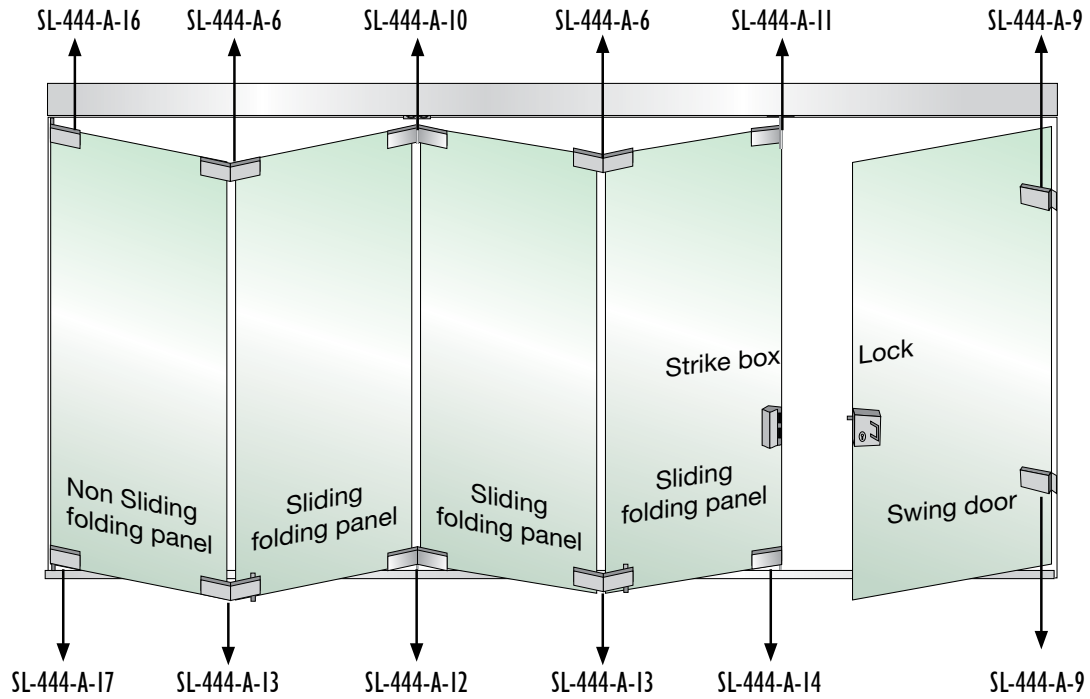

Plan View

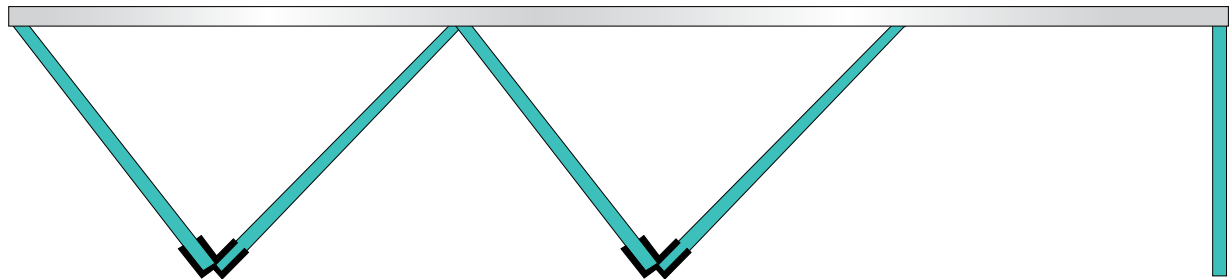

SL-444-TT 3mtr AN ₹ 12,300
SL-444-TT 4mtr AN ₹ 16,100
Top Track



SL-444-BT 3mtr SSS ₹ 7,720
SL-444-BT 4mtr SSS ₹ 10,100
Bottom Track



SL-444-TT-C 3mtr SSS ₹ 8,290
SS Cover for Track SL-444-TT



SL-444-A6 STD SSS ₹ 5,940
Glass to Glass Interconnecting Hinge



SL-444-A10 STD SSS ₹ 7,029
Glass to Glass Connector With Roller



SL-444-A11 STD SSS ₹ 4,180
End Sliding Folding Panel Fitting with Roller



SL-444-A12 STD SSS ₹ 6,677
Glass to Glass Connecting Hinge with Guide Locator



SL-444-A13-L/R STD SSS ₹ 8,305
Glass to Glass Connecting Hinge with Floor Lock

SLIDING DOOR SYSTEM - 444

Finish : SSS

Glass Thickness: 10-12mm



SL-444-A9 STD SSS ₹ 3,718
Glass to Wall Hinge
for Single Action Doors



SL-444-A14 STD SSS ₹ 3,344
End Sliding Folding Panel
Fitting with Guide Locator



SL-444-A16 STD SSS ₹ 4,367
End Panel Fitting with
Top Pivot



SL-444-A17 STD SSS ₹ 4,246
End Panel Fitting with
Bottom Pivot



SL-444-A18-L STD SSS ₹ 4,499
End Panel Fitting with
Bottom Pivot (for odd panels)



SL-444-A18-R STD SSS ₹ 4,499
End Panel Fitting with
Bottom Pivot (for odd panels)



SDL-14A STD SS ₹ 12,535
Sliding Door Lock with Knob



SDL-14B STD SS ₹ 9,281
Sliding Door Strike Box with
Knob



Note: Internal Application for Office and Home Partitions

GLASS PARTITION SYSTEM B

Finish : SSS

Glass Thickness: 10-12mm
Max Feasible Height: 3mtr

Product Code and MRP available as per project requirement



Plan View



<p>OMPS B-1 Lower door strip (single latch)</p>	<p>OMPS B-2 Upper door strip/shaft sleeve</p>	<p>OMPS B-3 Upper door strip/roller</p>	<p>OMPS B-4 Lower door strip (double pins)</p>
<p>OMPS B-5 Lower door strip (side bolt+jack)</p>	<p>OMPS B-6 Lower door strip (surface bolt + jack)</p>	<p>OMPS B-7 Lower door strip (side bolt+latch)</p>	<p>OMPS B-8 Lower door strip (surface bolt+side bolt)</p>
<p>OMPS C-2 Track</p>	<p>OMPS C-5 Rail (T - piece)</p>	<p>OMPS C-6 Rail (Elbow)</p>	

GLASS PARTITION SYSTEM W

Finish : SSS

Glass Thickness: 10-12mm
Max Feasible Height: 3mtr

Product Code and MRP available as per project requirement



Top View

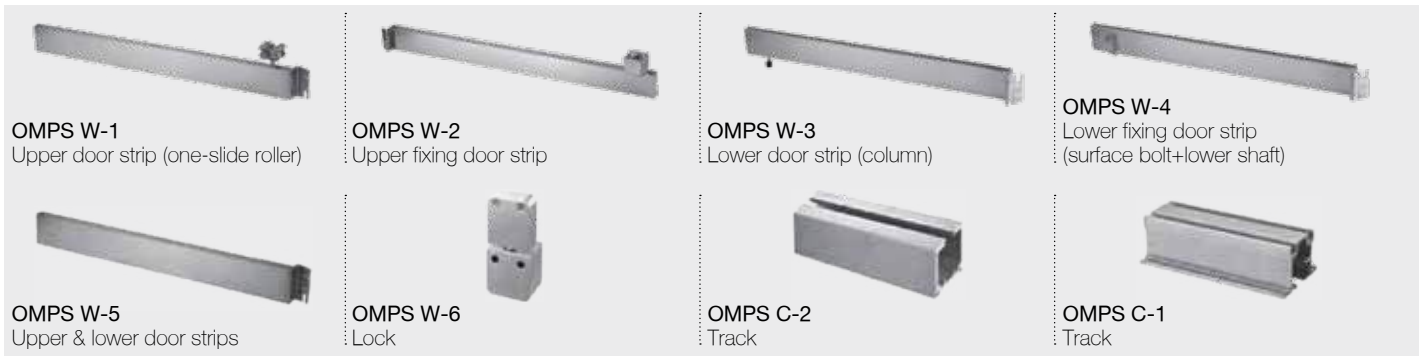
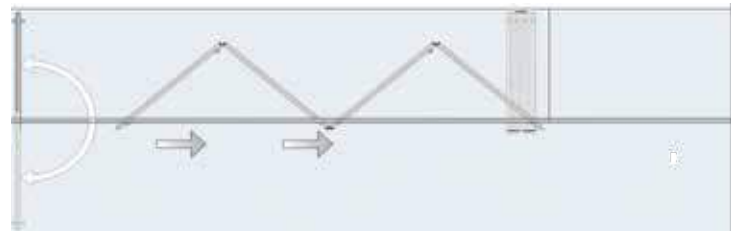

GLASS PARTITION SYSTEM Z

Finish : SSS

Glass Thickness: 10-12mm
Max Feasible Height: 3mtr

Product Code and MRP available as per project requirement



Top View

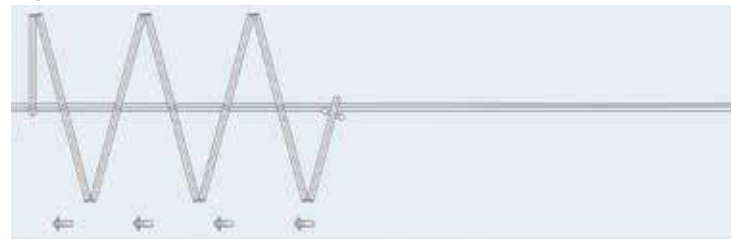

TWISTED SPIDER FITTINGS WITH FIN



SS-316

Finish: PSS



Key Features:

- Curvilinear design reduces stress concentration at transition points
- Twisted arm design gives higher strength
- No dome nut visible on fin side glass
- Compatible with all Ozone routels
- CTC 200mm



OSP-T-4D STD PSS ₹ 6,380
4 Way Spider with Fin



OSP-T-2D STD PSS ₹ 4,510
2 Way Spider with Fin



OSP-T-44D STD PSS ₹ 3,355
2 Way Spider for Ceiling/ Wall



OSP-T-22D STD PSS ₹ 2,379
1 Way Spider for Ceiling/ Wall

FACADE SPIDER FITTINGS WITHOUT FIN



SS-316

Finish: PSS



Key Features:

- Sleek casted arm design for higher strength
- Tapered arm design provide lateral stiffness against wind-load
- Compatible with all existing OZONE routels
- CTC 200mm



OSP-B-204 STD PSS ₹ 5,170
4 Way Spider



OSP-B-202 STD PSS ₹ 3,355
2 Way Spider (180°)



OSP-B-202A STD PSS ₹ 3,740
2 Way Spider (90°)



OSP-B-201 STD PSS ₹ 2,420
1 Way Spider

GLASS CLAMP GLAZING SYSTEM (Rhombus Spider)

SS-316

Finish: PSS & SSS (on order)

Tested as per International Standard



Side View

OSP-RB-F4K PSS ₹ 13,200

Two/Four Way Spider with Fin

SPIDER FITTINGS WITH FIN (Standard Series - 200mm Arm Distance)

SS-316

Finish: PSS & SSS

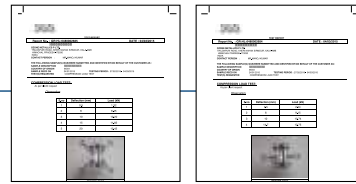

OSP-A2 STD SSS ₹ 5,830

OSP-A2 STD PSS ₹ 6,380

2 Way Spider with Fin



OSP-A4 STD SSS ₹ 6,250

OSP-A4 STD PSS ₹ 6,900

4 Way Spider with Fin



OSP-A22 STD SSS ₹ 2,882

OSP-A22 STD PSS ₹ 3,300

1 Way Spider for Ceiling/ Wall



OSP-A44 STD SSS ₹ 3,388

OSP-A44 STD PSS ₹ 3,850

2 Way Spider for Ceiling/ Wall

SPIDER FITTINGS WITHOUT FIN (Standard Series - 220mm Arm Distance)

SS-316

Finish: PSS & SSS



OSP-B-221 STD SSS ₹ 3,839

OSP-B-221 STD PSS ₹ 4,015

1 Way Spider without Fin



OSP-B-222 STD SSS ₹ 4,532

OSP-B-222 STD PSS ₹ 4,840

2 Way Spider without Fin 180°



OSP-B-222A STD SSS ₹ 5,280

OSP-B-222A STD PSS ₹ 5,555

2 Way Spider without Fin 90°



OSP-B-223 STD SSS ₹ 6,325

3 Way Spider without Fin



OSP-B-224 STD SSS ₹ 6,655

OSP-B-224 STD PSS ₹ 7,150

4 Way Spider without Fin



OSP-B-224-90 STD SSS ₹ 13,640

OSP-B-224-90 STD PSS ₹ 14,355

4 Way Spider 90° without Fin

SPIDER FITTINGS WITH FIN (200mm Arm Distance)

SS-316

Finish: PSS

Product Dimension & Glass cutout details are same as of standard series 'OSP-A'



OSP-A2-316E STD SSS ₹ 4,950
2 Way Spider with Fin



OSP-A4-316E STD SSS ₹ 5,600
4 Way Spider with Fin



OSP-A22-316E STD SSS ₹ 2,530
1 Way Spider for Ceiling/ Wall



OSP-A44-316E STD SSS ₹ 2,915
2 Way Spider for Ceiling/ Wall

SPIDER FITTINGS WITHOUT FIN (220mm Arm Distance)

SS-316

Finish: PSS

Product Dimension & Glass cutout details are same as of standard series 'OSP-B'



OSP-B-221-316E STD SSS ₹ 3,234
1 Way Spider without Fin



OSP-B-222-316E STD SSS ₹ 3,905
2 Way Spider without Fin 180°



OSP-B-222A-316E STD SSS ₹ 4,565
2 Way Spider without Fin 90°



OSP-B-223-316E STD SSS ₹ 5,390
3 Way Spider without Fin



OSP-B-224-316E STD SSS ₹ 5,885
4 Way Spider without Fin

SPIDER FITTINGS WITH FIN (200mm Arm Distance)



OSP-A2-304 STD SSS
2 Way Spider with Fin

SSS	₹ 5,390
PSS	₹ 5,995



OSP-A4-304 STD SSS
4 Way Spider with Fin

SSS	₹ 6,325
PSS	₹ 6,325

FIN PLATES

(Also Available in 450mm, 500mm & 600mm)

Finish: PSS & SSS



OSP-FP-150 SSS ₹ 7,040
Fin Plate 150mm



OSP-FP-300 SSS ₹ 9,680
OSP-FP-300 PSS ₹ 10,450
Fin Plate 300mm



OSP-FP-350 SSS ₹ 11,110
OSP-FP-350 PSS ₹ 11,880
Fin Plate 350mm



OSP-FP-400 SSS ₹ 12,210
OSP-FP-400 PSS ₹ 12,815
Fin Plate 400mm

SPLICE PLATES

Finish: SSS & PSS



OSP-SP-170 Price on request
Splice Plate 170mm



OSP-SP-300 SSS ₹ 8,855
OSP-SP-300 PSS ₹ 9,460
Splice Plate 300mm



OSP-SP-350 SSS ₹ 10,890
OSP-SP-350 PSS ₹ 11,330
Splice Plate 350mm



OSP-SP-VS-400 Std PSS ₹ 12,760
Splice Plate for Holding Two Fins

ROUTELS

SS-316

Finish: SSS & PSS



OSP-FB-FL STD SSS ₹ 1,221
OSP-FB-FL STD PSS ₹ 1,540
 Fixed Bolt (Flat Head)
 Finish: SSS / PSS



OSP-FB-CS STD SSS ₹ 1,221
OSP-FB-CS STD PSS ₹ 1,375
 Fixed Bolt (Counter Sunk Head)
 Finish: SSS / PSS



OSP-AFB-36-CS STD SSS ₹ 1,859
 Articulate Bolt (Counter Sunk Head)
 Finish: SSS / PSS



OSP-AFB-36-FL STD SSS ₹ 2,222
OSP-AFB-36-FL STD PSS ₹ 2,662
 Articulate Bolt (Flat head)
 Finish: SSS / PSS

New



OSP-AFB-36FL-DGU ₹ 3,135
 Articulated routel for DGU,
 for holding inner glass only
 Finish: SSS / PSS



OSP-AFB-40-FL-DGU ₹ 3,520
 Articulated Routel for 40mm
 DGU Glass
 Finish: SSS / PSS



OSP-B-AR-12(8+12+12) ₹ 748
 Aluminium Ring for Insulated Glass
 Finish: Aluminium



OSP-SH-01 Std. SS ₹ 1,529
 To Hold Without Fin
 Spiders to Structure

E Series



OSP-AFB-36-FL-316E Std SSS ₹ 1,925
 Articulate Bolt (Flat head)
 Finish: SSS

E Series



OSP-FB-FL-316E Std SSS ₹ 1,056
 Fixed Bolt (Flat Head)
 Finish: SSS

E Series



OSP-FB-FL 304 SSS ₹ 1,271
 Fixed Bolt (Flat Head)
 Finish: SSS

SS-304



OSP-AFB-36-FL 304 SSS ₹ 2,035
 Articulate Bolt (Flat head)
 Finish: SSS

FRAMELESS GLASS CANOPY SYSTEMS

Finish: SSS



OCF-22-TR ₹ 31,350

Trio shaped Wall mounted Canopy Fitting with Glass on Top.

- Stainless Steel 304 Grade
- Max. Glass Size (using 2 fittings) 1800mm* 1100mm
- Supplied in Pair W/O Glass
(Glass available on special demand)



OCF-01 STD SSS ₹ 6,710
Wall to Glass Connector
Finish: SSS



OCF-02 STD SSS ₹ 7,535
Adjustable Glass Connector
for OCF-316
Finish: SSS



OCF-03 STD SSS ₹ 6,160
Wall Fitting for OCF 316
Finish: SSS



OCF-316 STD SSS
Threaded Sleeve for OCF-ROD
Supplied In Pairs
Finish: SSS

SSS ₹ 13,750
PSS ₹ 13,750



OCF-ROD-16mm SSS
for OCF-316
Finish: SSS

SSS ₹ 2,607
PSS ₹ 2,607

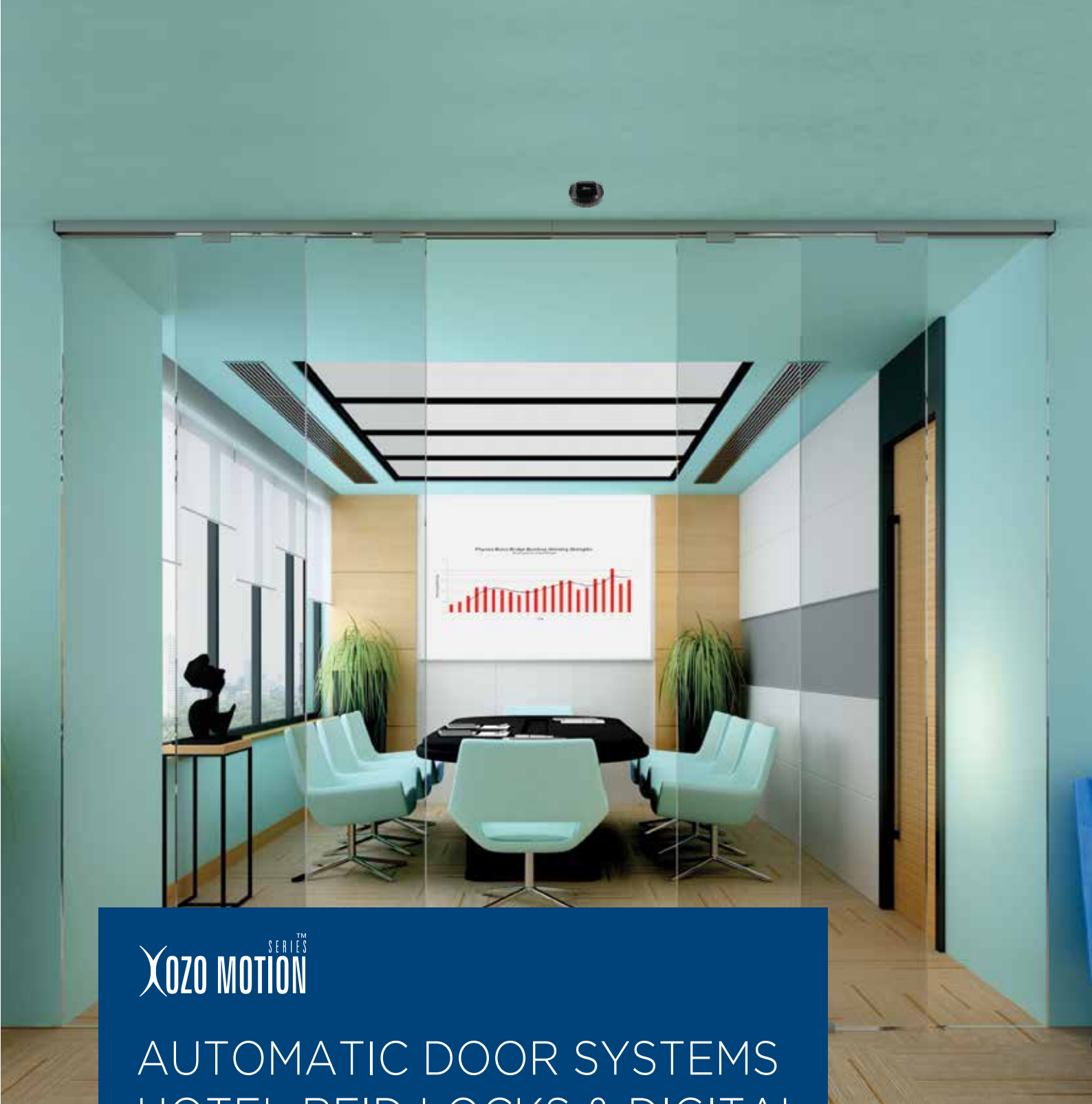

XOZO MOTION SERIES™

AUTOMATIC DOOR SYSTEMS HOTEL RFID LOCKS & DIGITAL LOCKS

Ozone Automatic Door systems are designed to meet the ease of entry, safety & security requirements. The flexibility in design & installation allows Ozone Automatic Door systems to get integrated in any type of architecture.

EASY PLUS AUTO SLIDING DOOR SYSTEM

OZOM-111E-PLUS-N 4.2mtr. ₹ 96,250

Compact & Slim body | Intelligent Controller | Modular Design | Noiseless Functionality



Features:

- Engine case, height: 128mm
- Engine case cover height: 150mm
- Self learning micro computer processing controller
- Adjustable tensioner wheel
- 24V DC 65W brushless motor
- Digital adjustable parameters
- Controller with built-in remote control receiver
- Inbuilt electromagnetic locking

Specifications:

- Single / bi-parting sliding door system
- Suitable door weight : 100 Kg x 2
- Max door width : 2 mtr
- Adjustable parameters for opening speed, closing speed, opening buffer speed, closing buffer speed, opening buffer distance, closing buffer distance, opening time & opening force
- Integration possible with Microwave Sensor, Handwave Sensor, PIR Sensor, Digital Door Key, Finger Print Controller Wireless Push Button, Safety Beam, Remote Control, Push Buttons etc



Track length option:

- 4.2mtr

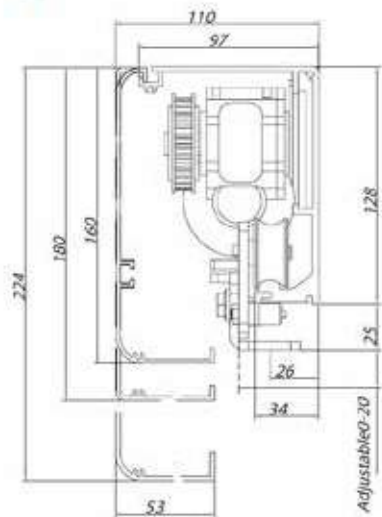

PREMIUM PLUS AUTO SLIDING DOOR SYSTEM



OZOM-111P-PLUS 4.2mtr.	₹ 1,42,010
OZOM-111P-PLUS 5.2mtr.	₹ 1,57,850
OZOM-111P-PLUS 6.0mtr.	₹ 1,69,510

Compact & Slim body | Noiseless Functionality | Intelligent Controller | Modular Design



Track length option:

- 4.2mtr/5.2mtr/6mtr

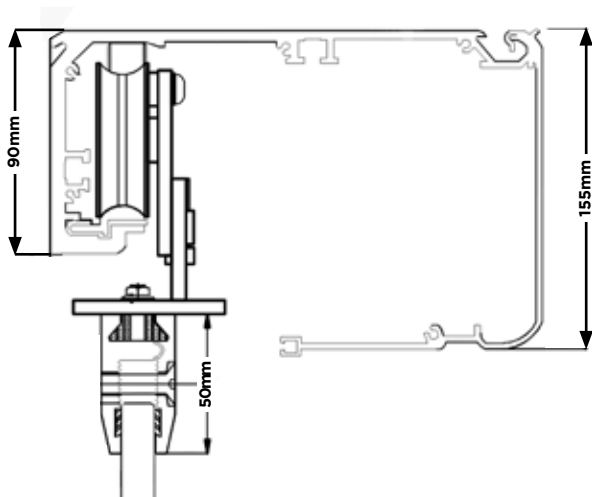

Features:

- Engine case, height: 90mm
- Self-learning microcomputer processing controller
- Slim type track
- 24V DC 65W brushless motor with built-in rectifier
- Adjustable parameters
- Engine case cover height: 155mm
- Controller with built-in remote control receiver
- Adjustable tensioner wheel
- Operating standard cycle for 5,000,00 cycles in-house tested

Specifications:

- Single/bi-parting sliding door system
- Suitable door weight : 120Kg x 2
- Max door width : 2/2.5/3mtr
- Adjustable parameters for opening speed, door buffer distance, door buffer intensity, closing speed, closed buffer distance, closed buffer force, opening hours & starting force
- Integration possible with Microwave Sensor, Handwave Sensor, PIR Sensor, Digital Door Key, Wireless Push Button, Safety Beam, Remote Control, Push Buttons etc

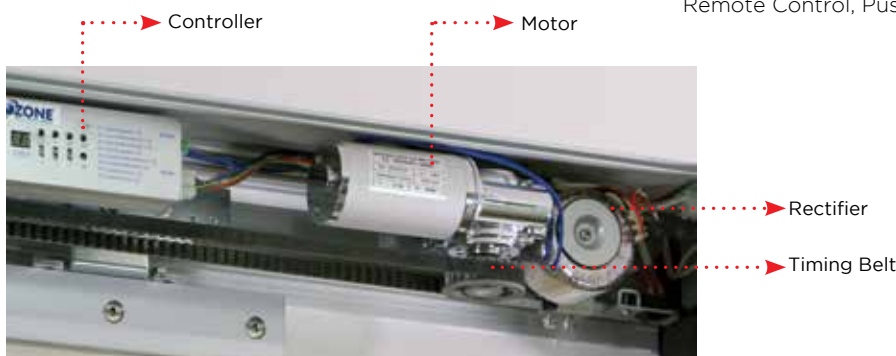

AIRDRIVE-The WORLD'S SLIMMEST Automatic Sliding Door System
with tiniest yet powerful operator of only 68 mm height

S Series
Premium Collection of
Architectural Hardware

OZOM-AD68N 4.5MTR.	₹ 2,76,650
OZOM-AD68N 5.9MTR.	₹ 2,94,250



Features:

- Manufactured as per ISO 9001:2000 standards
- CE conformity & compliant with EU Standards EN 16005, EN 60335, EN ISO 13849 1:2008 & German standard DIN 18650
- Exquisiteness combined with strength & soft performance
- Ability to work with 20% higher or lower than nominal input voltage
- Completely protected system input ports which reduces the damage risk due to human error during installation
- Self-diagnose and error detection
- Ability to automatically adjust speed and slopes according to input voltage change
- Best choice for professionals who wish to create pure beauty & graceful architecture

Specifications:

- Track/engine case: 68 x 135 mm (ht x depth)
- Track length: 4.2 & 5.9 mtr
- Door type: automatic
- Single leaf door weight: 1 x 150kg
- Double leaf door weight: 2 x 120kg
- Maximum door opening width: 2000 mm for single panel & 3000 mm for double panel
- Motor: compliant with EU low voltage directives with maximum power consumption of 250W
- Opening speed: adjustable 100-550mm/sec
- Closing speed: adjustable 100-500mm/sec

Slimmest Track of 68mm height

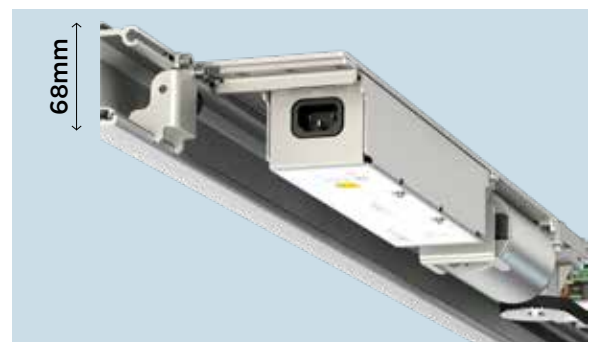

OZONE PLUS GLIDE MAGNETIC SLIDING DOORS



Ozone Plus Glide is an automatic sliding door system that runs on a magnetic linear motor technology which is safe, noiseless and reliable technology. It reduces operating cost hence is a cost effective solution for commercial spaces like offices, hotels & hospitals. Ozone Plus Glide System can be applied in any of the entrances and can be integrated with door control devices.

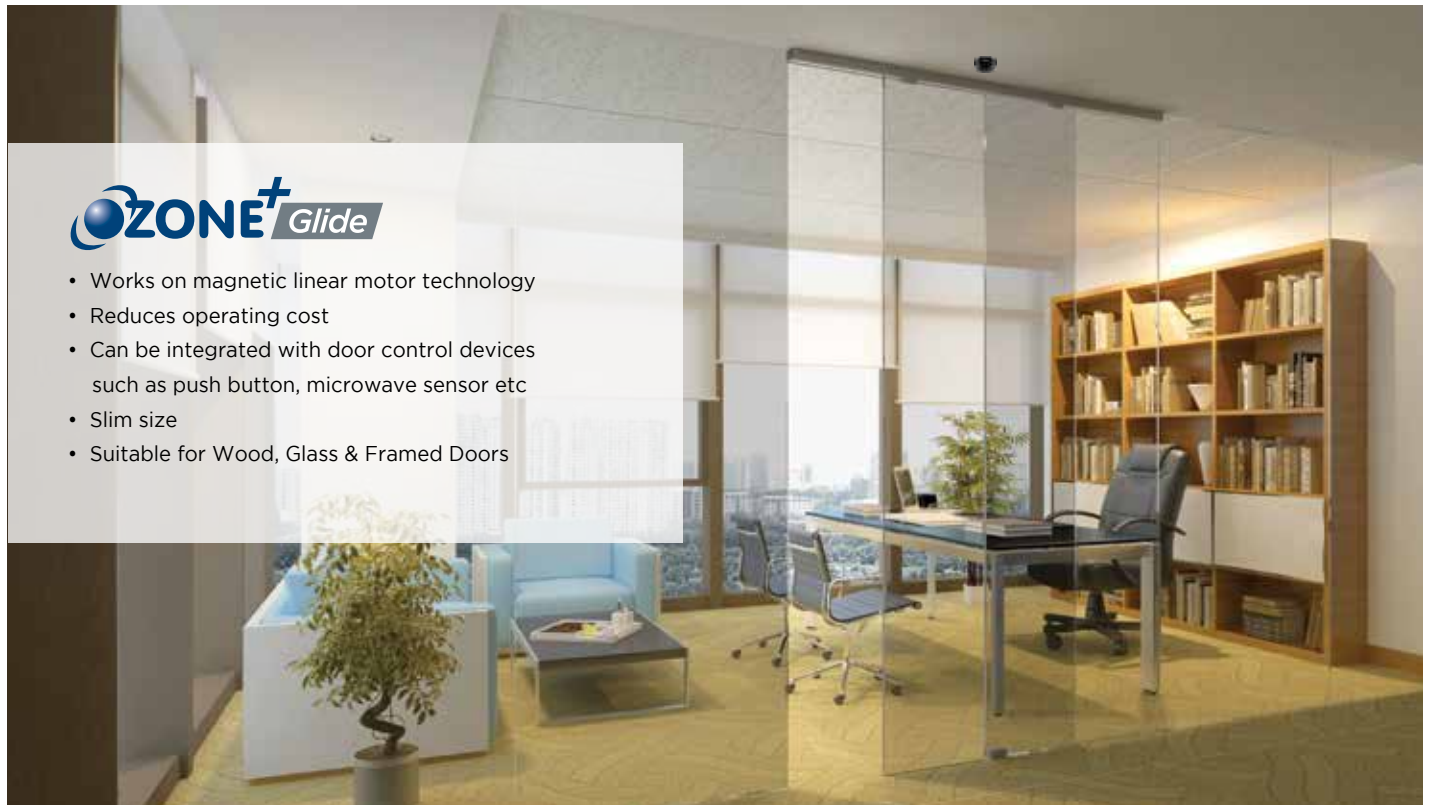

- Works on magnetic linear motor technology
- Reduces operating cost
- Can be integrated with door control devices such as push button, microwave sensor etc
- Slim size
- Suitable for Wood, Glass & Framed Doors



Accessories:



Wireless Push Buttons
2 Nos. - Black/White
(Provided with Product Packing)



OZOM-SG-ACC-01 ₹ 2,541
Remote Control

OZONE PLUS GLIDE MAGNETIC SLIDING DOORS



OZOM-SG-080 2.1mtr.	₹ 1,20,010
OZOM-SG-080 4.2mtr.	₹ 2,07,350

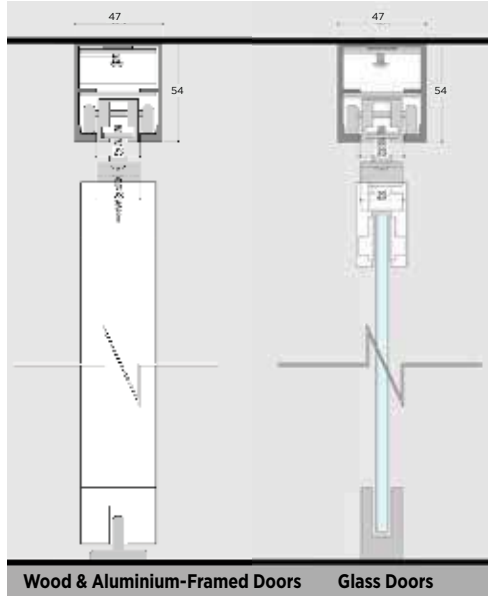

Technical specifications:

- Movement range: 750-1000mm
- Door weight: 30-80kg
- Opening/closing speed: 200-500mm/s
- Hold open time: 0-30sec
- Magnetic holding power: Suction 10N
- Manual opening: ≤ 10N
- Anti-pinch force: ≤ 10N
- Average power: 30W
- Track length: 2100mm

Functions:

- Standard configuration: automatic mode, manual opening
- Adjustment of opening/closing speed and hold open time
- Automatic memory
- Smooth sliding operation
- Anti-pinch and overload protection
- Can be used with external control switch

Smart Glide OZOM-SG-150

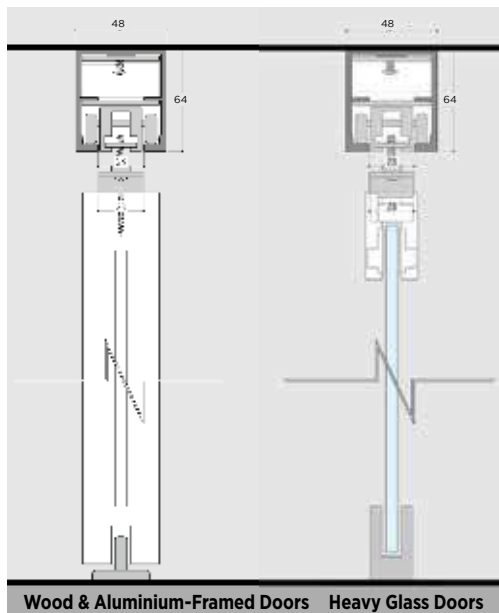

Technical specifications:

- Movement range: 750-1000mm
- Door weight: 50-150kg
- Opening/closing speed: 200-500mm/s
- Hold open time: 0-30sec
- Magnetic holding power: Suction 10N
- Manual opening: ≤ 10N
- Anti-pinch force: ≤ 10N
- Average power: 30W
- Track length: 2100mm

Functions:

- Standard configuration: automatic mode, manual opening
- Adjustment of opening/closing speed and hold open time
- Automatic memory
- Smooth sliding operation
- Anti-pinch and overload protection
- Can be used with external control switch

AUTOMATIC SLIDING DOOR SYSTEM WITH PANIC BREAKOUT



OZOM-PB-G STD Price on Request



Best for larger door passage requirement



Get wider door opening with panic breakout feature



Panic breakout feature facilitates quick evacuation

Specifications:

Single leaf Door Weight	100 Kg
Double leaf Door Weight	100x2 Kg
Power consumption	200W
Ambient temperature	-30-+50° C
Motor	Dunkermotoren from Germany
PSA control Panel	37 parameters could be set
Track and Cover	High strength, 5mm thickness

Features:

- Includes overlapping frames and sealing to ensure airtightness
- Intelligent design, easy to install and adjust
- UPS backup battery ensures the door operating 30 minutes normally if power fails
- Automatic stop function
- Push open at any position

Applications:

- Airports, Shopping Malls, Car Showrooms, Warehouses

TELESCOPIC AUTOMATIC SLIDING DOORS

Ozone Telescopic Automatic Door System is designed to work on double pulley mechanism that enables wider door opening with less parking space. With our Telescopic Automatic Door System, you can achieve upto 3mtr wide door opening making it best suitable even for automobile showrooms and areas of high traffic movement.

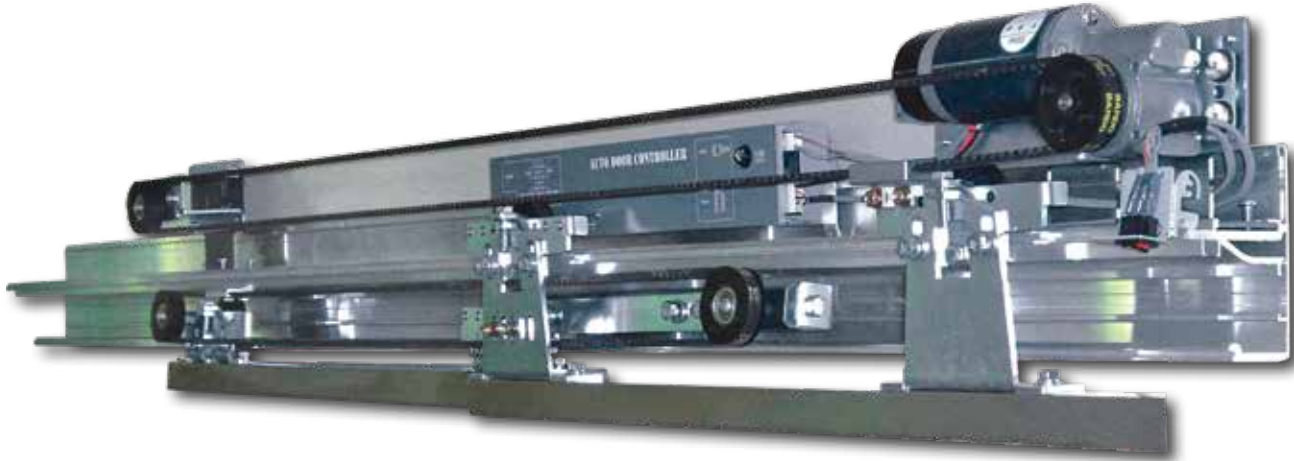

OZOM-11-T 4.2mtr.	₹ 2,44,200
OZOM-11-T 5.0mtr.	₹ 2,59,600

Telescopic Automatic Sliding Door System with one on one panel

TECHNICAL PARAMETER-	OZOM - 11T
Power	AC 220V (50-60 Hz), AC 110v (option)
Controller	Micro-Processing
Motor	DC 24V 60W/90W
Door weight max.	90kg x 2/125kg x 2
Door width	Min. 550mm
Opening time	0-10 sec.(Adjustable)
Power Transfer	UPS, Program switch



Features:

- For a wider door opening space, install 02 panels door in a space of one
- 02 door panels move at 2:1 speed ratio at the same time.
- Telescopic Door does not have a profile cover so provisions for hiding the system assembly with any paneling material is required.

AUTOMATIC SLIDING DOOR SYSTEM FOR SINGLE DOOR

S Series
 Premium Collection of
 Architectural Hardware

OZOM-11F-S-SYS STD SSS	₹ 1,25,400
OZOM-11F-S-TRACK 2 MTR SSS	₹ 29,150



Features:

- Designed in compliance with EN 16005 Low Energy Operating Standard for 500,000 cycles
- Slim Size Track (mm): (H)75 x (W)77 x (L)2000mm
- Can be converted to semi-automatic door
- For Internal applications

Specifications:

- Suitable for door weight: 20-80Kg
- Power supply 100-240V AC ; 50/60 Hz
- Power consumption 5W in stand-by mode & 40W (max) in automatic mode
- 2mtr. aluminium track with SS finish
- For single panel sliding door, frameless glass or framed door
- Same product & installation of right to left or left to right door opening
- Integration possible with microwave sensor, wireless push button, digital door key (RFID Card access control), hand wave sensor etc
- Can be operated by gentle manual push to the door
- High degree temperature resistance belt (20°-130°)
- Safety beam barrier not required

Certified : CE, EN 16005
 Low Voltage European Directive
 2014/35/EU



Hanger Roller

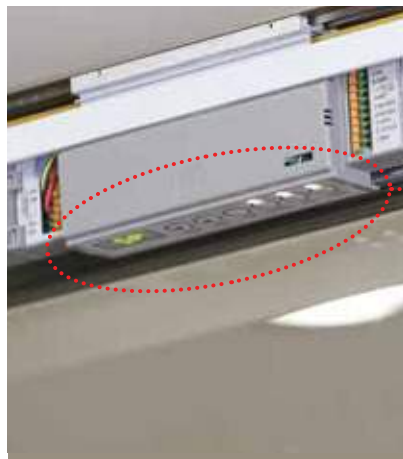

Controller

AUTOGLIDE SLIDING DOOR SYSTEM (RETRO FIT)

S Series
Premium Collection of
Architectural Hardware

OZOM-AG-01 STD BLACK ₹ 55,220



Inside View of the Controller

Features:

- Converts existing manual sliding door or window into automatic sliding
- Suitable for residential applications

Specifications:

- Single leaf door weight: 80Kg
- DC 24V 45W brushless motor
- Can be installed on doors of kitchen, balcony, office, shop front, aisle, french window or other sliding windows
- Suitable door width: 500-1000 mm
- Voltage: AC 100-240V
- Opening speed: 10-45 cm/s (Adjustable)
- Closing speed: 10-25 cm/s (Adjustable)
- Compatible with sensor, remote control, push button, RFID card reader etc.

White Colour Option

(Available against confirmed orders)



Accessories:

- With 2 Nos. wireless push buttons/remote control



Wireless Push Button

SEMI AUTOMATIC SLIDING DOOR SYSTEM

OZOM-SA-111-N ₹ 37,950

The Semi Automatic Doors System is a sliding door which is opened manually but closes automatically on its own with the help of an air cylinder mechanism. It does not require any electrical connection. Another important feature of this door is that it closes softly on the last end making its closing very smooth and silent. The closing speed can be adjusted as per the traffic movement and opening size. The maximum door width possible for this system can be 1000mm (track length 2100mm) and the maximum door weight 80kg. The door can be integrated with standard locks. An ideal application for these doors is rest room entrances, conference rooms etc. The system can be used for frameless glass doors as well as framed/wooden doors.



Semi-Automatic Door Technical Parameters

TECHNICAL PARAMETERS	OZ-OM-SA-111
Single leaf maximum opening width	1000mm
Maximum door weight	80Kg
Maximum door height	2100mm
Door Type	Framed & Frameless doors
Door parking when open	Possible
Glass cutout	Not required

Features:

- Suitable for Frameless glass doors, wooden doors & framed doors
- Door open manually and closes automatically
- Come with in-built air cylinder mechanism
- No electrical connection required
- Soft & Silent door closing
- Closing Speed can be adjusted
- Standard locks available in market can be integrated

Ideal Application: Rest room entrances, office cabins, conference rooms, meeting rooms

OZOM-AC-99 Std Black ₹ 8,470

Microwave Sensor

High sensitivity, wide range eagle type sensors with least interface with industrial noise.

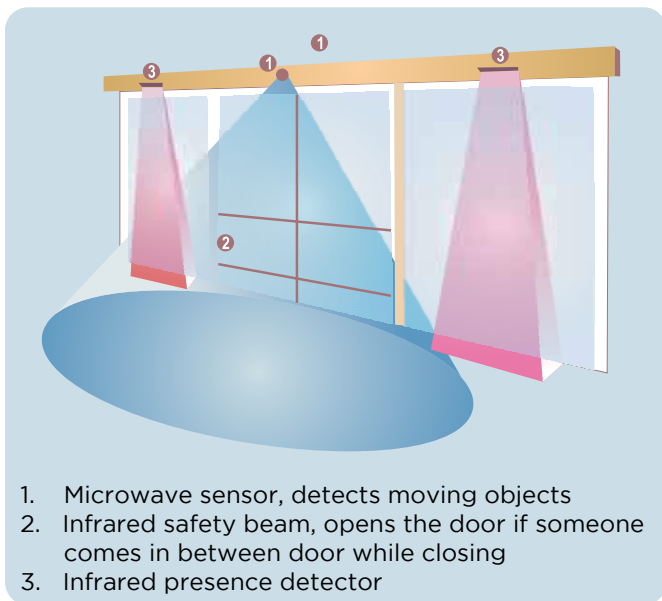

Technical Specification

Technology	Microwave and Microprocessor
Transmitter frequency	24.125 Ghz
Transmitter radiated power	<20dBm EIRP
Transmitter power density	<5mW/cm ²
Detection mode	Motion
Minimum detection speed	5 cm/s (measure in the sensor axis)
Supply voltage	12V-24V AC+/-10%, 12V-30V DC
Mains frequency	50 to 60 Hz
Max. power consumption	<2W (VA)
Output	relay (free of potential change-over contact)
• Max. contact voltage	42V AC-60V DC
• Max. contact current	1A (resistive)
• Max. switching power	30W (DC)/60VA (AC)
Max. mounting height	3m
Protection degree	IP54
Temptrature range	from- 20°C to +55°C

Specification are subject to change without prior notice

OZOM-ACC-55 ₹ 7,040

Microwave Sensor



Avoid extreme vibration



Do not cover the sensor



Avoid moving objects & light sources in the detection field



Avoid highly reflective objects in the infrared field

Microwave Sensor: High sensitivity, wide range eagle type sensors with least interface with industrial noise. Infrared Sensor for Active and presence detector.

Opening & safety sensor for automatic sliding doors

Other use of the device is outside the permitted purpose and can not be guaranteed by the manufacturer. The manufacturer cannot be held responsible for incorrect installations or inappropriate adjustments of the sensor.

OZOM-AC-11-ZS ₹ 14,850

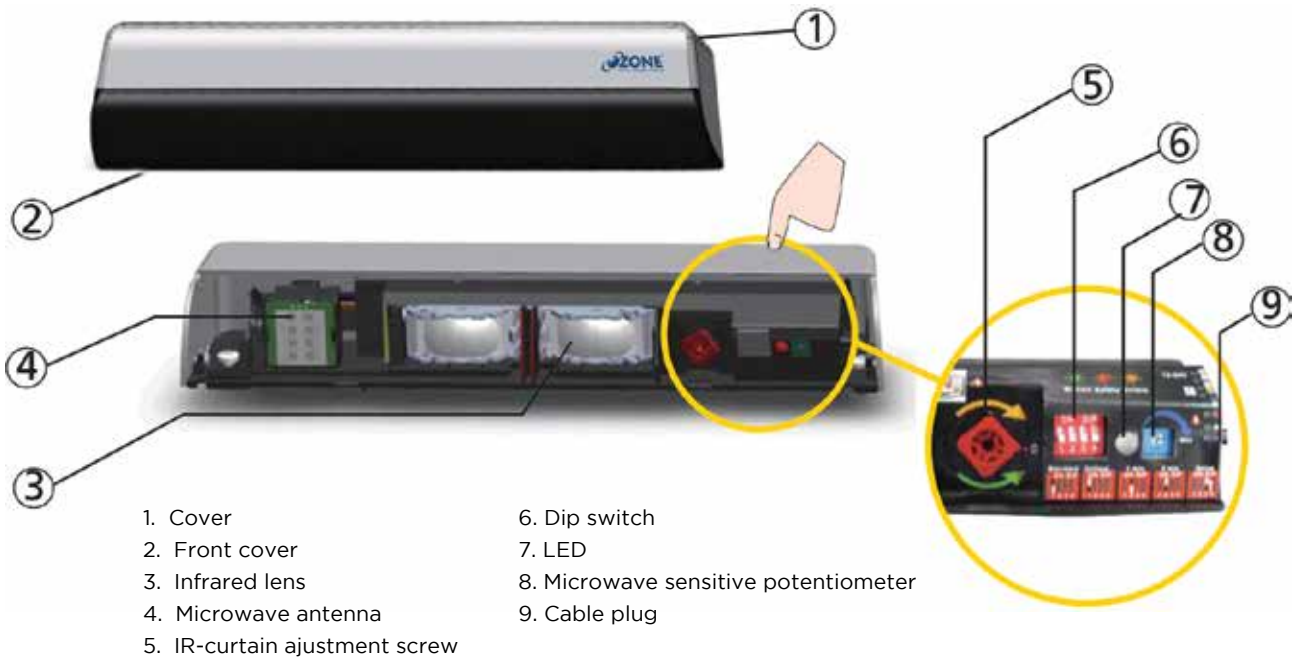

Technical Specification

Supply voltage:	12 V-24 V AC +/-10% ; 12 V-30 V DC 0%/+10%	
Power consumption:	< 3W	
Mounting height:	1.8m to 3m	
Temperature range:	-25°C to +55°C	
Degree of protection:	IP54	
Detection mode:	Motion Min. detection speed: 5cm/s	Presence Typical response time: <128ms (max. 500ms)
Technology:	Microwave doppler radar Transmitter frequency: 24.150 GHz Transmitter radiated power: <20 dBm EIRP Transmitter power density: <5 mW/cm2	Active infrared with background analysis Spot diameter: 6cm (typ) Number of spots: 24 by curtain Number of curtains: 1
Angle:	From 15° to 45° vertical (adjustable)	From -5° to +8° (adjustable)
Output:	Relay (free of potential) Max. contact voltage: 42 V AC/DC Max. contact current: 1A (resistive) Max. switching power: 30W (DC)/60 VA (AC)	Relay (free of potential) Max. contact voltage: 42V AC/DC Max. contact current: 1A (resistive) Max. switching power: 30W (DC)/60 VA (AC)
Hold time output signal:	0.5s	0.5s

Specification are subject to change without prior notice

AUTO DOOR ACCESSORIES



1mtr ₹ 4,477
1.5mtr ₹ 6,463

OZOM-PR-11

Aluminium clamp
Available in 1mtr. & 1.5mtr (pair)



OZOM-FG-11 ₹ 682

Floor guides for frameless glass doors (pair)



OZOM-FG-22 ₹ 1,089

Floor guides for framed doors with adjustable width (pair)



OZOM-DDK-11 ₹ 17,710

Digital Door Key (RFID & Numeric ID)



OZOM-FPC-11 ₹ 7,480

Controller Fingerprint



OZOM-11P-AC-11 ₹ 5,720

Remote Control for Automatic Sliding Door



OZOM-SW-11 ₹ 352

Large area push button for automatic doors



OZ-SW-11M ₹ 1,309

Metallic wall mounting push button switch

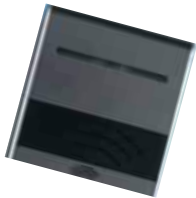

OZOM-HWS-11 ₹ 10,516

Hand Wave Sensor



Single Barrier ₹ 9,119
Double Barrier ₹ 14,190

OZOM-SB-11N STD SS (Single Barrier)
OZOM-SB-12 (Double Barrier)



OZOM-SB-11N ₹ 9,350

(Single Barrier)
Use with OZOM-111E



OZOM AC-66 PIR ₹ 21,120

Ceiling mounting PIR sensor



OZOM-111P-PLUS Remote ₹ 3,465

Remote Control



OZOM-111E-PLUS N Remote ₹ 3,465

Remote Control

AUTOMATIC SWING DOOR OPERATORS FOR GLASS AND WOODEN DOORS



SINGLE ACTION OVERHEAD DOOR OPERATOR



200Kg



OZOM-SD-200 STD AN ₹ 86,350

Automatic overhead door operator

DOUBLE ACTION CONCEALED DOOR OPERATORS



150Kg



OZOM-CSD-T STD SS ₹ 1,09,450

Top Mounted Concealed Door Operator



OZOM-CSD-B STD SS ₹ 1,09,450

Bottom Mounted Concealed Door Operator

Applications:

- Hospitals
- Hotels
- Passage/Lobby
- Specially-abled Toilets
- Retail Outlets
- Offices/Residential apartments/ Public Buildings
- Airports

Operator can be integrated with:

- Microwave sensor
- Foot switch sensor
- Handwave sensor
- Electromagnetic locking machine
- RFID/Numeric/Fingerprint access control system
- Push Button

AUTOMATIC SWING DOOR OPERATORS TECHNICAL DATA TABLE

TECHNICAL PARAMETERS	OZOM-SD-200 STD AN	OZOM-CSD-T STD SS	OZOM-CSD-B STD SS
Max. Door Width	1500mm	1500mm	1500mm
Max. Door Weight	200kg	150KG	150KG
Opening Direction	Single action	Double Action	Double Action
Accessories Included	Controller, machine and remote	Controller, machine and remote	Controller, machine and remote
Installation Type	Top Installation	Top Installation	Floor Installation
Maximum Motor Power	65W/100W	65W/100W	65W/100W
Motor	DC 24V 55W/100W Brushless Motor	DC 24V 55W/100W Brushless Motor	DC 24V 55W/100W Brushless Motor
Closing Speed	10-43cm/s	3-14cm/s	3-14cm/s
Open Door Hold Time	0.5-10 s	0.5-10 s (adjustable)	0.5-10 s (adjustable)
Open Range	70° - 115°	±90°	±90°
Supply Voltage	AC110V/AC220V 50Hz- 60Hz	AC110V/AC220V 50Hz- 60Hz	AC110V/AC220V 50Hz- 60Hz
Use Temperture	-30° C - +50° C	-30° C - +50° C	-30° C - +50° C
Use Humidity	Less than 85%	35 - 85%RH (non-condensing)	35 - 85%RH (non-condensing)
Protection Level	IP64	IP64	IP44
Extended Function	Safety light eyes, such as remote control of various types of access control	Safety light eyes, such as remote control of various types of access control	Safety light eyes, such as remote control of various types of access control
Watt Power	14W	14W	14W
Fuse	Minimum 3.5A Slow	Minimum 2.5A	Minimum 2.5A
Maximum Current	1A	1A	1A
Dimensions	544x72x106 mm	288x86x72 mm	340x82x166 mm
Single/Double Door use	One set for single door, 2 set for double with common accessories	One set for single door, 2 set for double with common accessories	One set for single door, 2 set for double with common accessories
Product Image			

Product Code and MRP available as per project requirement

REVOLVING DOOR SYSTEMS



A building entrance should ensure smooth & secure traffic passage at the same time add aesthetic value. Hence a door system should be chosen which meets functional as well as aesthetic requirements. Ozone Revolving Doors are just the right fit for such building entrances. They offer varied security & functionality benefits along with outstanding user experience and impart a spectacular look to the entrance.

OZONE Revolving Door Systems:

- Available with 3 or 4 leaf configuration
- Automatic and manual options
- Certified for EN 16005: 2012 & EN 60204-1: 2006+A1: 2009 to meet safety & functional standards
- Suitable for main entrances of commercial establishments
- Ensure safe & smooth Traffic flow
- Anti-collision & Anti-squeeze Function
- Custom solutions available
- Technical support provided



Emergency Stop Button



Slow Turning Feature for Specially Aabled People

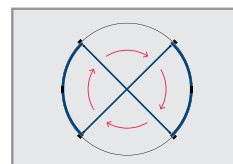

Can be 3 or 4 Leaf Door



3 Mode Selection Lock Key



Side & Bottom Brushes to Prevent AC Loss



Radar Detectors

Manual Revolving Door Technical Parameters

DOOR PARAMETERS	MANUAL REVOLVING DOOR
Type of drive unit	Manual
Roof outside color	Anodized
Roof outside	Water proof with 2 side drainages
Diameter	1800-3600mm
Total height	2500mm
No. of door leaves	3/4 leaf
Optional accessories (Additionally Charged)	Speed control system & panic breakout available

Automatic Revolving Door Technical Parameters

DOOR PARAMETERS	AUTOMATIC REVOLVING DOOR
Type of drive unit	Automatic
Roof outside color	Anodized
Roof outside	Water proof with 2 side drainages
Diameter	1800-3600mm
Total height	2500mm
No. of door leaves	3/4 leaf
Door locking	Key locking with drop bolt
Lighting	3x12V decoration light
Accessories	Emergency stop button, drive unit, button programme switch & handicap switch (2 sets)
Sensor	Radar sensor
Safety Sensor	Leading mullion sensor (safety sensor for inside and outside entrance)
Power supply	220V/AC 3 10% 50 Hz
High speed adjustment range	1-4 RPM
Low speed adjustment range	0.5 - 1.5 RPM
Motor Power	250W
Lighting power	300W
Control system power	50W

Email to support@ozone-india.com to know more about these energy-efficient and secure revolving door systems.

Technical specification will vary as per project requirement

Product Code and MRP available as per project requirement

HERMETICALLY SEALED FRAMED DOORS*

Ozone offers a new range of specialized doors for application in hospitals, X-ray rooms, research labs, clean rooms, environment controlled R&D centers etc. The range includes Hermetically Sealed Framed Doors & X- Ray Shielding Doors.

For more details mail to support@ozone-india.com



- Adopting original air-tight technology rubber pad and a rail-way arranged at the bottom of the door leaf ensures weather proof solution.
- Door with sealing strips on all four sides. Aluminum alloy section, dynamic beam with life span of more than 1 million operations.
- Controllers like foot sensing switch, microwave sensors, remote controller, electronic lock switches, infra red sensors, ATM card reader, password and card reader, and proximity sensors ensures that operation of the door has various options to suit every one.

Product Code and MRP available as per project requirement

X-RAY SHIELDING DOORS*



- 2mm lead layer to protect humans from hazardous X-rays.
- Rubber seal strips for hygienic requirements.
- SS 304 kick plate 150mm
- Provided with hand wave or foot sensor
- Round tube door handle
- Door filter rigid polyurethane

Hermetically Sealed & X-Ray Shielding Door Technical Parameters



OZOMH-FS-11
Foot Sensor Switch
 Activates the door to open when the switch senses the foot.

DOOR PARAMETERS	HERMATICALLY SEALED DOOR	X-RAY SHIELDING DOOR
Max. Door Weight	160kg / leaf	160kg / leaf
Door Width	1070mm to 1570mm	1070mm to 1570mm
Total Opening Width Required	2350mm to 3350mm	2350mm to 3350mm
Installation Possibility	Surface mounted	Surface mounted
Opening Speed	25-55cm/sec (Adjustable)	25-55cm/sec (Adjustable)
Closing Speed	25-55cm/sec (Adjustable)	25-55cm/sec (Adjustable)

***Available against orders only**

OZOM-AS-45DB 85MM STD
OZOM-AS-52DB 100MM STD

Price quoted as per project requirement

Available against orders only



STANDARD SPECIFICATIONS:

Movable Acoustic Wall Partition System shall consists of top hung manually operated acoustic panels which can be linked together to form an acoustic wall.

PANELS: Based on the requirement the panels shall be constructed of board separated by acoustic insulation to achieve the specified sound rating. Panel Faces are replaceable at the site.

ACOUSTICS: Acoustic walls are classified by a STC (Sound Transmission Class) rating for their effectiveness in reducing transmitted sound. Based on Acoustic Requirements the panels shall be of STC 45 or STC 52. STC 45 shall make the wall with loud speech barely audible on other side & STC 52 shall make the wall with shouting barely audible on other side.

CLOSURE: The movable acoustic wall shall be acoustically opened & closed with the help of an expanding panel located at the stacking end of the system. There is an over-sleeve on the expanding panel which can be expanded side ways to lock the acoustic wall in place. The oversleeve is expanded and retracted by a removable handle in the face of pane.

STACKING: While opening of movable acoustic wall, panels shall be parked in a side stack configuration which means that single panels are hung at two points at the top corners of each panel. Panels will stack with one point remaining on the main track and other on the side track.

SEALS: There shall be sweep seals at the top of the panels to seal them acoustically to the track. There shall be retractable seals at the bottom of the panels to seal them acoustically to the floor.

For wooden partitions:

Panel Thickness	DB Value	Max. Panel Height	Max. Panel Width
85 mm	45 DB	12000	1250
100 mm	52 DB	12000	1250

For glass (see through) partitions:

Panel Thickness	DB Value	Max. Panel Height	Max. Panel Width
85 mm	43 DB	6000	1200

Price quoted as per project requirement

OMAW-MOVABLE ACOUSTIC WALL PARTITION SYSTEM

Stacking Options

One Point Suspension & perpendicular to track

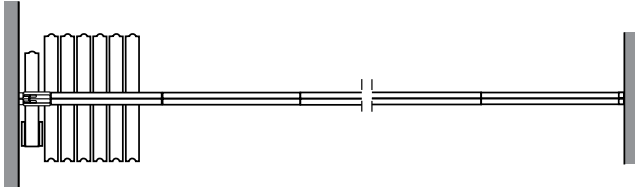

Two Point Suspension & perpendicular to track

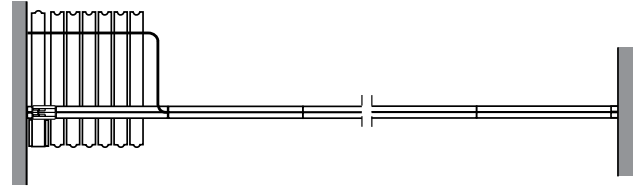

Two Point Suspension & parallel to track



Two Point Suspension, perpendicular to track & multiple stacks

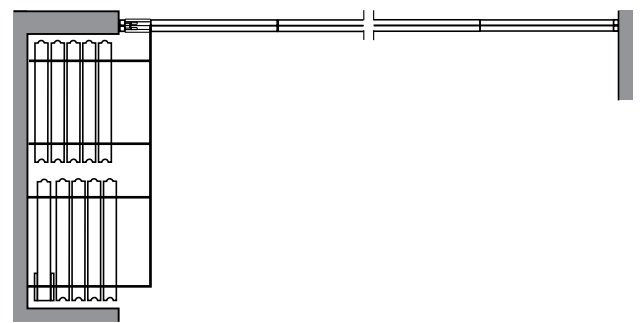

Two Point Suspension, perpendicular to track in closed compartment

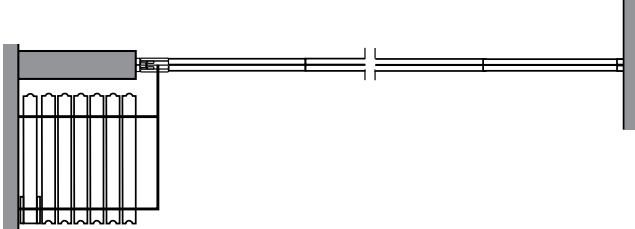

Scan QR Code for Installation Video



HOTEL RFID CARD LOCKS



New

OZEL-RF-V9-666 L Std. Silver	₹ 6,820
OZEL-RF-V9-666 R Std. Silver	₹ 6,820

Software Based Hotel Door Lock



→ Inside Room Controller

→ Door Bell

→ Power Saver



DO NOT DISTURB



CHECK IN



MAKE UP ROOM

OZ-DND-01 Std Black	₹ 9,020
OZ-DND-02 Std Black	₹ 11,100

HOTEL DND SYSTEM

Function: Make up room, do not disturb bell, hotel name & room number display

ACCESSORIES FOR V9-666 L/R STD LOCKS



₹ 3,140

OZEL-RF-V9-ACC-PS
White Std
Power Saver



₹ 16,700

OZEL-RF-V9-ACC-DC
Std White
Data Collector



₹ 14,150

OZEL-RF-V9-ACC-CR
Std Black
Card Reader



₹ 132

OZEL-RF-V9-ACC-CARD
Std White
RFID Card



OZEL-RF-V11-444 R/L SSS	₹ 11,600
OZEL-RF-V11-444 R/L PSS	₹ 12,020

Software Based Hotel Door Lock



OZEL-RF-V11-555 R/L SSS	₹ 8,800
OZEL-RF-V11-555 R/L PSS	₹ 8,800

Software Based Hotel Door Lock

ACCESSORIES FOR V-11 LOCKS



₹ 135

OZEL-RF-V11-ACC-CARD
Std Std
RFID Card



₹ 1,850

OZEL-RF-V11-ACC-QC
Std Std
Query Card



₹ 3,140

OZEL-RF-V11-ACC-PS
White Std
Power Saver (30 AMP)



₹ 20,900

OZOM-RF-HLS
Hotel Lock
Management S/W



₹ 15,500

OZEL-RF-V11-ACC-CR
Black Std
Card Reader

APP CONNECTED DIGITAL LOCK
FOR SLIDING AND SWING GLASS DOORS

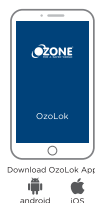

360 Degree Fingerprint Recognition

Specifications:

- Suitable for Glass door thickness of **10mm-15mm**
- Material- Zinc Alloy

Features:

- 4 ways access: Mobile App, Fingerprint, RFID Card, User Pin Code
- Automatic Locking System
- Passsage (open) Mode

Applications:

- Residential Apartments, Libraries, Offices, Hospitals

OZ-FGL-BL-G2G Black ₹ 29,900

Glass to glass application

OZ-FGL-BL-G2W Black ₹ 29,700

Glass to wall application

Access Options:



Fingerprint



RFID Card



User Pin Code



Mobile Access

FINGERPRINT DIGITAL GLASS DOOR LOCK
LOCK WITH 4 IN 1 ACCESS



Specifications:

- 4 Way Access - Fingerprint, RFID Card,
- User Pin Code & Remote Control (optional)
- Automatic Locking Function
- Doorbell Function
- Passage (open) Mode

Features:

- Voice Guided Operating Feature
- Dual Combination Access
- LCD Screen Displays Date, Time & User ID
- Auto Secure Feature
- Code Scrambling Function
- Emergency Battery Backup Through USB
- Suitable for Glass **Door Thickness of 10-12 mm**
- Volume Settings
- Low Battery Status Indicator

Applications:

- Residential Apartments • Libraries • Offices
- Hospitals • Other High Security and Premises



OZDL-23PCF-G2G STD ₹ 28,820

Glass to glass application

OZDL-23PCF-G2W STD ₹ 25,630

Glass to wall application

Access Options:



Fingerprint



RFID Card



User Pin Code



Remote Control (Optional)

Optional Accessories:



OZDL-23RC-GL ACC ₹ 3,465

Remote

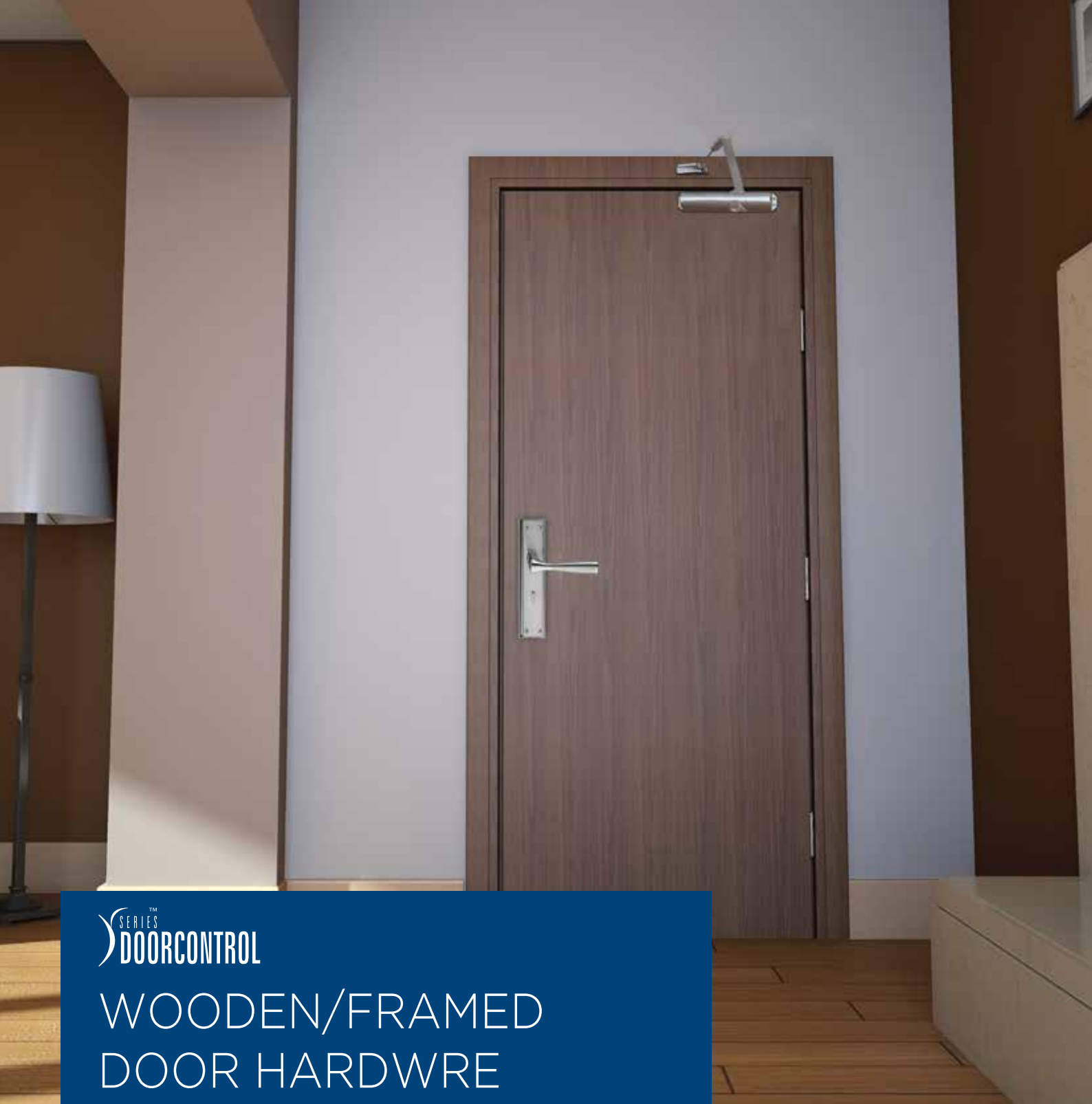

SERIES
DOORCONTROL

WOODEN/FRAMED DOOR HARDWARE

Ozone offers a wide range of Tested & Certified Door Control Devices for all types of doors, be it glass, wood or metal door. Apart from functional performance, every door hardware is designed to meet modern interiors aesthetic needs. With introduction of new Door Handles, the range is further strengthened to be more competent and offer numerous choices to customers. Explore the range yourself to review the latest additions in the range.



CONTRACTOR KY SERIES - OCX.KY

Finish : CP/SN



OCX.KY1.STD CP/SN ₹ 1,474
Material : Zinc Alloy
Finish : CP/SN



OCX.KY2.STD CP/SN ₹ 1,474
Material : Zinc Alloy
Finish : CP/SN



OCX.KY3.STD CP/SN ₹ 2,013
Material : Zinc Alloy
Finish : CP/SN



OCX.KY4.STD CP/SN ₹ 2,112
Material : Zinc Alloy
Finish : CP/SN

PREMIUM SERIES - OPX

Finish : CP/SN



OPX.001 RS CP/SN ₹ 3,399
Handle with Square Rose
Material : Zinc Alloy
Finish : CP/SN



OPX.002 RS CP/SN ₹ 2,970
Handle with Square Rose
Material : Zinc Alloy
Finish : CP/SN

CONTRACTOR BT SERIES - OCX.BT

(Suitable for Bathroom Doors) Finish : CP/SN



OCX.BT2 STD CP/SN ₹ 1,474
Handle Set with Baby Latch
Material : Zinc Alloy
Finish : CP/SN

CONTRACTOR PRO SERIES - OCXP

Finish : CP/SN



OCXP.001.K60 RS CP/SN	₹ 4,125
OCXP.001.N60 RS CP/SN	₹ 4,169
OCXP.001.K70 RS CP/SN	₹ 4,389
OCXP.001.N70 RS CP/SN	₹ 4,389

Kit Includes: Handle set, Mortise Lock Body & Euro Profile Cylinder
Material : Zinc Alloy
Finish : CP/SN



OCXP.001.K60 8" CP/SN	₹ 3,740
OCXP.001.N60 8" CP/SN	₹ 3,729
OCXP.001.K70 8" CP/SN	₹ 3,960
OCXP.001.N70 8" CP/SN	₹ 3,960

Kit Includes: Handle set, Mortise Lock Body & Euro Profile Cylinder
Material : Zinc Alloy
Finish : CP/SN



OCXP.002.K60 RS CP/SN	₹ 3,729
OCXP.002.N60 RS CP/SN	₹ 3,729
OCXP.002.K70 RS CP/SN	₹ 3,872
OCXP.002.N70 RS CP/SN	₹ 3,949

Kit Includes: Handle set, Mortise Lock Body & Euro Profile Cylinder
Material : Zinc Alloy
Finish : CP/SN



OCXP.002.K60 8" CP/SN	₹ 3,740
OCXP.002.N60 8" CP/SN	₹ 3,729
OCXP.002.K70 8" CP/SN	₹ 3,927
OCXP.002.N70 8" CP/SN	₹ 3,960

Kit Includes: Handle set, Mortise Lock Body & Euro Profile Cylinder
Material : Zinc Alloy
Finish : CP/SN



OCXP.002.K60 10" CP/SN	₹ 3,740
OCXP.002.N60 10" CP/SN	₹ 3,740
OCXP.002.K70 10" CP/SN	₹ 3,872
OCXP.002.N70 10" CP/SN	₹ 3,949

Kit Includes: Handle set, Mortise Lock Body & Euro Profile Cylinder
Material : Zinc Alloy
Finish : CP/SN

CONTRACTOR SERIES - OCX

Finish : CP/SN

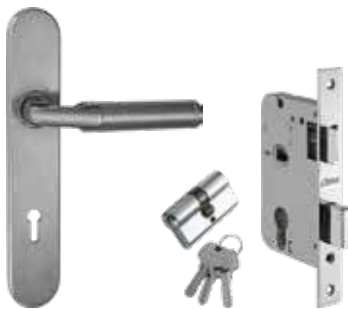

OCX.001.K60 8" CP/SN	₹ 3,080
OCX.001.N60 8" CP/SN	₹ 3,080
OCX.001.K70 8" CP/SN	₹ 3,289
OCX.001.N70 8" CP/SN	₹ 3,322

Kit Includes: Handle set, Mortise Lock Body & Euro Profile Cylinder
Material : Stainless Steel & Zinc Alloy
Finish : CP/SN



OCX.001.K60 10" CP/SN	₹ 3,289
OCX.001.N60 10" CP/SN	₹ 3,289
OCX.001.K70 10" CP/SN	₹ 3,520
OCX.001.N70 10" CP/SN	₹ 3,586

Kit Includes: Handle set, Mortise Lock Body & Euro Profile Cylinder
Material : Stainless Steel & Zinc Alloy
Finish : CP/SN



OCX.004.K60 RS SN	₹ 3,289
OCX.004.N60 RS SN	₹ 3,311
OCX.004.K70 RS SN	₹ 3,520
OCX.004.N70 RS SN	₹ 3,597

Kit Includes: Handle set, Mortise Lock Body & Euro Profile Cylinder
Material : Zinc Alloy
Finish : SN

CONTRACTOR SERIES - OCX

Finish : CP/SN



OCX.006.K60 8" CP/SN	₹ 2,607
OCX.006.N60 8" CP/SN	₹ 2,695
OCX.006.K70 8" CP/SN	₹ 2,827
OCX.006.N70 8" CP/SN	₹ 2,926

Kit Includes: Handle set, Mortise Lock Body & Euro Profile Cylinder
Material : Zinc Alloy
Finish : CP/SN



OCX.006.K60 RS CP/SN	₹ 3,025
OCX.006.N60 RS CP/SN	₹ 3,080

Kit Includes: Handle set, Mortise Lock Body & Euro Profile Cylinder
Material : Zinc Alloy
Finish : CP/SN

INOX SERIES - Solid Casted

Finish : SSS



OMH-11C STD SSS	₹ 2,662
------------------------	----------------

Mortise Handle in SSS Finish
Material : Stainless Steel
Grade : 304
Finish : SSS



OMH-22C STD SSS	₹ 2,629
------------------------	----------------

Mortise Handle in SSS Finish
Material : Stainless Steel
Grade : 304
Finish : SSS

TUBULAR MORTISE HANDLES - OMH

Finish : SSS/PSS & Black Matt



OMH-11 STD SSS ₹ 1,419

Tubular Mortise Handle in SSS Finish
Material : Stainless Steel
Grade : 304
Finish : SSS

OMH-11 19mm STD SSS ₹ 1,280

Tubular Mortise Handle in SSS Finish
Material : Stainless Steel
Grade : 304
Finish : SSS

OMH-11N STD SSS/PSS ₹ 1,573

Tubular Mortise Handle in SSS Finish
Material : Stainless Steel
Grade : 304
Finish : PSS/SSS



OMH-11L STD SSS ₹ 1,309

Mortise Handle in SSS Finish
Material : Stainless Steel
Grade : 304
Finish : SSS

OMH-11LN STD SSS ₹ 1,309

Mortise Handle in SSS Finish for Narrow Style Doors
Material : Stainless Steel
Grade : 304
Finish : SSS

OMH-11LN STD BM ₹ 1,749

Mortise Handle for Narrow Style Doors
Material : Stainless Steel
Grade : 304
Finish : Black Matt



OMH-33 STD SSS ₹ 1,518

D-Type Mortise Handle with Plate
Material : Stainless Steel
Grade : 304
Finish : SSS

OMH-33P STD SSS ₹ 2,739

D-Type Mortise Handle with Plate
Material : Stainless Steel
Grade : 304
Finish : SSS

OMH-44 STD SSS ₹ 1,375

Mortise Handle in SSS Finish
Material : Stainless Steel
Grade : 304
Finish : SSS



OMH-55 STD SSS ₹ 1,364

Mortise Handle in SSS Finish
Material : Stainless Steel
Grade : 304
Finish : SSS

OPKL-K2N-STD SSS ₹ 1,749

Mortise Handle with POD Lock in SSS Finish
Material : Stainless Steel
Grade : 304
Finish : SSS

MORTISE LOCK BODY

Finish : SSS, CP & Black Matt



OML-11A-F 45/85 SSS ₹ 1,859
OML-11A-F 55/72 SSS ₹ 1,914
 Fire Rated Mortise Lock Body with deadbolt & Latch bolt



OML-11A 45x85mm SSS ₹ 1,474
 Closed Body Mortise Lock with Strike Plate, Double Throw Dead Bolt & Latch Bolt



OML-11BT-N STD STD ₹ 1,375
 Mortise Lock Body with Strike Plate

Compatible to OIL-R & OIL-S (to buy separately)



Does not require lock cylinder



₹ 1,221
OZML-DL1 55MM SSS
 Closed Body Mortise Lock with Strike Plate, Double Throw Dead Bolt



₹ 1,364
OZML-DL1-F 55MM SSS
 Closed Body Mortise Lock with Strike Plate, Double Throw Dead Bolt



E Series ₹ 545
OZML-L1-E-O 46.5MM SSS
 Mortise Lock Body with Strike Plate and Soft Closing Latch Bolt



E Series ₹ 627
OML-11-E 50x50MM CP
 Closed Body Mortise Lock with Dead Bolt & Latch Bolt

Suitable to use with 8" Plate Handles



E Series SSS ₹ 737
OML-11-E2 45x85 CP
OML-11-E2 45x85 SSS
 Closed Body Mortise Lock with Dead Bolt & Latch Bolt



New
₹ 1,400
OML-11 60x85MM SSS
 Closed Body Mortise Lock with Dead Bolt & Latch Bolt



OML-DD-R 50x85MM SSS ₹ 2,112
OML-DD-L 50x85MM SSS ₹ 2,112
 Mortise Lock Body with Latch Bolt & Dead Bolt for **Wood Double Doors**



OML-SL-STD SSS ₹ 737
 Mortise Lock Body with Allen Key

NARROW STYLE MORTISE LOCK BODY

Finish : SSS & Black Matt



OML-33A 30x85MM SSS ₹ 1,111
Narrow Style Lock Body for Aluminium Doors with Latch & Dead Bolt



OML-33A 35x85MM SSS ₹ 1,111
Narrow Style Lock Body for Aluminium Doors with Latch & Dead Bolt



OZML-DL1-25MM SSS ₹ 952
Narrow Style Lock Body for Aluminium Doors with Dead Bolt

EURO PROFILE CYLINDERS FOR MORTISE LOCKS

Finish : SN & Black Matt

DEFEND PRO SERIES

Single Security Computerized Key System

Master & Grand Master Key Available

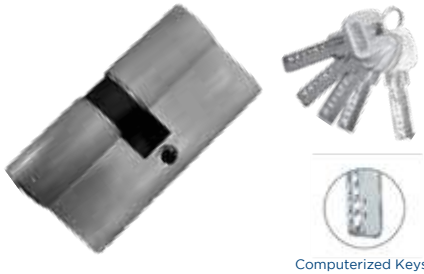

OMC-11-K2K-P-60MM SN ₹ 979
OMC-11-K2K-P-70MM SN ₹ 1,199
OMC-11-K2K-P-80MM SN ₹ 1,254

Both Side Keys
Finish: SN



OMC-11-K2N-P-60MM SN ₹ 1,056
OMC-11-K2N-P-70MM SN ₹ 1,221
OMC-11-K2N-P-80MM SN ₹ 1,254

One Side Key One Side Knob
Finish: SN



OML-CPP STD SSS ₹ 319
Cylinder Pull Plate
Finish: SSS

DEFEND SERIES - Normal Key

Master & Grand Master Key Available



OMC-22-K2K-N2-60MM SN ₹ 847
OMC-22-K2K-N2-70MM SN ₹ 902
OMC-22-K2K-N2-80MM SN ₹ 946

Both Side Keys
Finish: SN



OMC-22-HC-KEY-N2-45MM SN ₹ 539
Half Cylinder with
3 Brass Normal Keys
Finish: SN

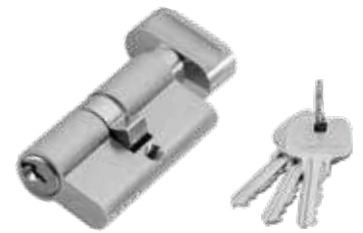

OMC-22-K2N-N2 60MM SN ₹ 1,023
OMC-22-K2N-N2 70MM SN ₹ 1,062
OMC-22-K2N-N2 80MM SN ₹ 1,122

One Side Key One Side Knob
Finish: SN



OMC-22-BT-N 60MM SN ₹ 787
OMC-22-BT-N 70MM SN ₹ 847
OMC-22-BT-N 80MM SN ₹ 935

Bathroom Type
Finish: SN



OMC-22-HC-KNOB-N2-45MM SN ₹ 644
Half Cylinder with Knob
Finish: SN

NIGHT LATCH LOCKS

Finish : SSS

SERIES SPEEDY

Features:

- High strength latch bolt/ dead bolt
- Safety knob ensures the security and privacy
- Restrict unauthorised access from outside
- Suitable for
 - Wooden or metal doors
 - Single or double doors
 - Door Thickness: 30-70mm
- Locking from outside by key, inside by knob



OZ-NL-11R STD SSS ₹ 1,353
OZ-NL-11L STD SSS ₹ 1,353

- Mini Latch
- Night latch for inside opening doors
 - Right & left handed
 - High security 3 brass keys



OZ-NL-22 STD SSS ₹ 1,947
 Night Latch

- Reversible latch bolt
- Double stroke dead bolt
- Reversible computerized Key - 4nos. (Brass)
- Suitable for inside/outside opening doors
- Holdback feature prevents any lockout situations



OZ-NL-33 STD SSS ₹ 3,289
 Night Latch (Single Latch+ Double Bolt)

- Reversible latch bolt
- Double dead bolt with double stroke
- Reversible computerized keys - 4nos(Brass)
- Suitable for inside/outside opening doors



OZ-NL-44 STD SSS ₹ 2,761
 Tri Bolt Night Latch

- Three strong bolt for triple bolt security
- No fear of accidental locking
- Dead bolts with double stroke
- Reversible computerized keys - 4nos. (brass)
- Suitable for inside/outside opening doors

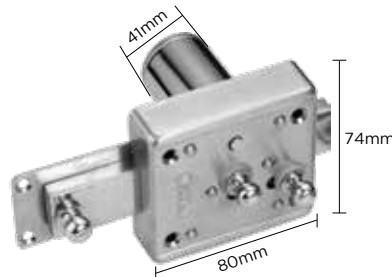

OZ-NL-55 STD SSS ₹ 1,199
 Interlock with 3 Stroke

- Dead bolt option available after shifting latch upwards
- Single sliding bolt with 3 stroke
- Reversible computerized keys - 4nos. (Brass)
- Door thickness:- 40mm

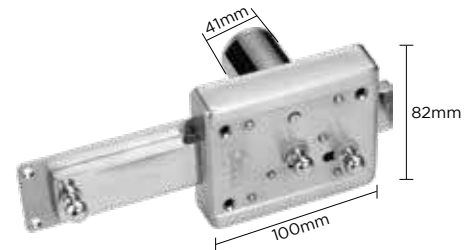

OZ-NL-66 STD SSS ₹ 1,419
 Interlock with 6 Stroke

CYLINDRICAL KNOB LOCKS

(Available in 60MM & 70MM Backset)

Finish : SSS



OCKL-11N STD SSS ₹ 957
OCKL-11N 70mm SSS ₹ 968

Knob Lock with Key Operation & Push Button



OCKL-22N STD SSS ₹ 886
OCKL-22N 70mm SSS

Knob Lock with Push Button & Coin Release



OCKL-33N STD SSS ₹ 886
OCKL-33N 70mm SSS

Knob Lock with both side Active Knobs

SS BUTT HINGES

* With Fixing Screws For Wooden Doors

Finish : SSS

SS Butt Hinges with Four Ball Bearings* SS-304



OZ-SSBH 4x3x2.5MM SSS ₹ 396



OZ-SSBH 4x3x3MM SSS ₹ 446



OZ-SSBH 5x3x3MM SSS ₹ 517

SS Butt Hinges with Two Ball Bearings*

SS-304



₹ 369

OZ-BH-2BB 4x3x2.5MM SSS



₹ 380

OZ-BH-2BB 4x3x3MM SSS



₹ 490

OZ-BH-2BB 5x3x3MM SSS

Fire Rated Butt Hinges with Two Ball Bearings*

SS-304



₹ 385

OZ-BHF-2BB-C 4x3x3MM SSS

SS Butt Hinges with & without Ball Bearings

SS-304



₹ 222

OZ-BH-NBB 4x2.5x2.5MM SSS



₹ 262

OZ-BH-NBB 5x2.5x2.5MM SSS

Economy Series without Ball Bearings



Series

SS-202



OZ-BH-NBB-E 3x2x1.3MM SSS ₹ 68



OZ-BH-NBB-E 4x2.5x2.5MM SSS ₹ 127



OZ-BH-NBB-E 5x2.5x2.5MM SSS ₹ 165

ADJUSTABLE Concealed Hinges

Finish : SSS



OZ-WD-ACH 40 LEFT/RIGHT STD SSS ₹ 2,222
Triple Adjustable Wooden Door Hinge
(for Door Wt.-40 Kg. with 2 Hinges)



OZ-WD-ACH 60 LEFT/RIGHT STD SSS ₹ 2,668
Triple Adjustable Wooden Door Hinge
(for Door Wt.-60 Kg. with 2 Hinges)

DOOR GUARD & STOPPER

Finish : SN, SS & SSS



OZ-DG-B-11-E STD ₹ 759

Door Guard Buckle Type



OZ-DG-B-11 STD SN ₹ 1,062

Door Guard Buckle Type



OZ-DG-22 STD SN ₹ 968

Door Chain



OZ-DST-11 STD SN ₹ 209

Door Stopper



OZ-DST-22 STD SN ₹ 473

Door Stopper



OZ-WST-11 STD SSS ₹ 275

Wall Mounted Door Stopper



OZ-DST-33F-N STD SS
Door Stopper

₹ 649



OZ-DST-44M STD SS
Magnetic Door Stopper for Wooden Doors

₹ 1,397



OZ-DST-55E STD SN
Door Stopper for Wooden & Framed Doors

₹ 275



OZ-MC Std Std
Magnetic Door Catcher for Cabinets

₹ 98



OWDS-11 900MM AN
OWDS-11 1Mtr AN
Drop Down Seal

900MM ₹ 2,607
1Mtr ₹ 2,882



OZ-DE-1 N.A. SS
220° Door Viewer

₹ 1,045



OZ-DE-1-E N.A. SS
200° Door Viewer

₹ 726



OZ-CFB-DP 300MM SSS
Concealed Flush Bolt

₹ 836

ESCUTCHEON WITH KNOBS

Finish : SSS



OML-LR STD SSS ₹ 385
Round Escutcheon



OML-N-LR STD SSS ₹ 385
Narrow Escutcheon



OIL-R STD SSS ₹ 825
Escutcheon with knob & occupied indicator for OML-11BT



OIL-S STD SSS ₹ 902
Escutcheon with knob & occupied indicator for OML-11BT

FOOT PLATE FOR TOUCH-LESS DOOR ACCESS

Finish : SSS



OZ-FP-01 ₹ 649
Foot Plate



- Specifications:**
- Suitable to use on wooden, steel and aluminium framed doors
 - Prevents spread of germs
 - Max. door load capacity: **80kg**
 - Finish: **SSS**
 - SS 304 Grade Material
 - Dimensions (mm): **70(L) x 100(W) x 3(Th)**

ALDROP

Finish : PSS/SSS

Available against bulk orders only



OZ-ALD-01 16*200mm ₹ 1,656
OZ-ALD-02 16*250mm ₹ 1,837
OZ-ALD-03 16*300mm ₹ 2,299
Finish: SSS



OZ-ALD-11E 16*300mm PSS/SSS ₹ 1,683
Finish: PSS/SSS

TOWER BOLTS

Finish : PSS/SSS

STANDARD TYPE

Standard Sizes



Grade: SS 304		Grade: SS 202	
MRP	Grade: SS 202	MRP	Grade: SS 202
OZ-TB-S 12" SSS ₹ 693	OZ-TB-SE 12" SSS ₹ 402	OZ-TB-S 10" SSS ₹ 578	OZ-TB-SE 10" SSS ₹ 347
OZ-TB-S 8" SSS ₹ 462	OZ-TB-SE 8" SSS ₹ 281	OZ-TB-S 6" SSS ₹ 341	OZ-TB-SE 6" SSS ₹ 204
OZ-TB-S 4" SSS ₹ 222	OZ-TB-SE 4" SSS ₹ 138		

Also available in PSS/SSS finish with SS 304 Grade

SQUARE TYPE



SS 304-SSS	MRP
OZ-TB-S11 12" SSS	₹ 759
OZ-TB-S11 10" SSS	₹ 611
OZ-TB-S11 8" SSS	₹ 501
OZ-TB-S11 6" SSS	₹ 391
OZ-TB-S11 4" SSS	₹ 259

PSS finish available on demand

OZ-TB-S 18" SSS & OZ-TB-S 24" SSS available on request
OZ-TB-SE 18" SSS & OZ-TB-SE 24" SSS available on request

OZ-TB-S11 18" SSS & OZ-TB-S11 24" SSS available on request

PANIC DOOR HARDWARE



Finish : SSS



1 Point Modular
Push Panic Bar for Single Door

OZ-PB-TCR-F-842MM SSS ₹ 11,660
Max Door Width : Upto 1100

OZ-PB-TCR-F-1020MM SSS ₹ 15,180
Max Door Width : Upto 1400



2 Point Modular
Push Panic Bar for Double Door

OZ-PB-TCV-F-842MM SSS ₹ 15,125
Max Door Width : 1100/2400

OZ-PB-TCV-F-1020MM SSS ₹ 16,940
Max Door Width : 1400/2400

Features :

- Push bar for fire and smoke check doors
- Stainless steel latch and security anti-thrust latch
- Certified as per UL 10C 1-3 HOURS FIRE RATED
 - For Hollow Metal Door: 3 Hours Fire Rated
 - For Wooden Door: 1.5 Hours Fire Rated

Accessories



OZ-PB-TCTRIM-F-STD SSS ₹ 3,548
External Trim



OZ-PBV-DLS-Std ₹ 1,007
Overlapping Cover
Strike Plate

CROSS PUSH PANIC BAR



OZ-PB-CRR-F-900mm Silver ₹ 6,490
Max Door Width : Upto 1200
Door Height 2300mm

Features :

- Cross bar for fire and smoke check doors
- **3 hours fire certified**
- Suitable for door Thickness 40-60mm
- Connecting rod length: 900mm
- Compatible with external trim
OZ-PB- CRTRIM-F-STD Silver

FIRE RATED CROSS PUSH PANIC BAR

Finish : SSS



OZ-PB-CRV-F-900mm Silver ₹ 8,833

Max Door Width: Upto 1200
Door Height 2300mm

Features :

- Cross bar for fire and smoke check doors
- **3 hour fire certified**
- Suitable for door Thickness 40-60mm
- Connecting rod length: 900mm
- Compatible with external trim
OZ-PB- CRTRIM-F-STD Silver

Accessory



OZ-PB-CRTRIM-F-STD Silver ₹ 3,069
External Trim

Features :

- Rectangular External Trim with lever handle for fire and smoke check doors
- 3 hour fire certified
- EN-1634-1:2008
- Max Door Thickness: 75mm
- Aluminum material grade
- Powder Coated finish
- Solid Square Spindle
- Master Key available on request Replaceable EP Cylinder with one side key operation
- Ideal for emergency exit of metal/Wooden single/double door

FIRE-RATED GRAVITY DOOR COORDINATOR



OZ-GDC-F-STD SILVER ₹ 7,040
For sequencing door closing action

Features

- Sequences the Door Closing i.e. roller arm stops active door from closing before the inactive door
- Gravity action arm and door bracket are adjustable on the jamb for ease of installation
- Nylon roller to enable the inactive door to easily operate

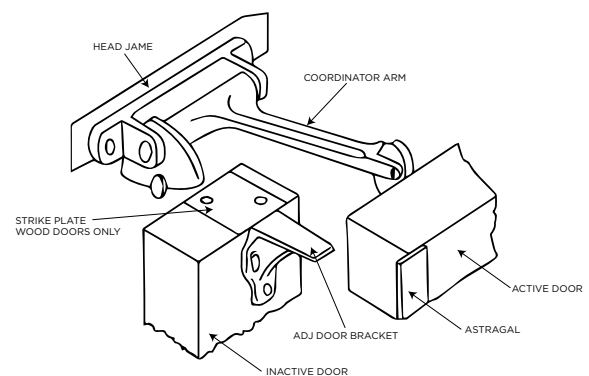

Specifications

- Device: Non-handed & reversible
- Projection: 6-1/2"
- Material: Forged brass with nylon roller
- Finish: Satin chrome

THE ORIGINAL SELF CLOSING PATCH FITTING
FOR WOODEN DOORS



Finish : SSS

100 Kg



Intertek	
TEST REPORT	
EN 1154	
Building hardware - Controlled door closing device	
Equipment and test methods	
Report Reference No.	IND00000220-003
Requested by name and signature:	Supersedes the report IND00000220-003 issued June 17, 2014
Approved by name and signature:	Geoffrey Chen
Date of issue:	04th April, 2015
Contents:	Total test report 18 pages including: Report text: 5 pages Appendix A for product photo: 7 pages Appendix B for product drawing and list of material: 7 pages Appendix C for installation instructions: 2 pages Appendix D for drawings: 1 page Revision page: 1 page
Testing Laboratory name:	Intertek Testing Services (Shenzhen) Ltd, Guangzhou, Branch
Address:	Block 5, No 2-2 Dongfeng Dong Software Science Park, Cante Road, Guangzhou Industrial City, 510130, Guangzhou, China
Testing location:	Office on site
Applicant's name:	OZONE INTERNATIONAL PVT LTD
Address:	1145, Balajigar, New Delhi - 110016, India
Test specification:	
Standard:	EN 1154:2008+A1:2014
Non applicable test method:	None
Test Report Title No.:	TTTF EN 1154: 1001 A
TTTF Engineer:	Intertek Testing Services (Shenzhen) Ltd, Guangzhou, Branch
Master TTTF:	Dated 2008-01
Test item description:	Controlled door spring for wooden door
Trade Mark:	OZONE
Model and/or type address:	OCFH-100/105, OCFH-100/105
Manufacturer:	Ecoguard India Door System Co., Ltd.
Reference:	
Summary of finding:	The submitted sample COMPLIED WITH all applicable mechanical performance requirements of EN 1154:2008+A1:2014 for fire ratings.

Specifications:

- Quick and easy installation
- Suitable door weight: Maximum 100kg
- Hold Open at 90°
- Material: SS 304

Standard packing includes top pivot set



EN 1154 Tested

THE ORIGINAL SELF CLOSING PATCH FITTING

OCFH-W-100 STD SSS ₹ 17,050

Suitable door width: 950mm
 Suitable door thickness: >40mm
 Suitable for Internal Doors with Power Size 3
 Standard package comes along with Top Pivot set

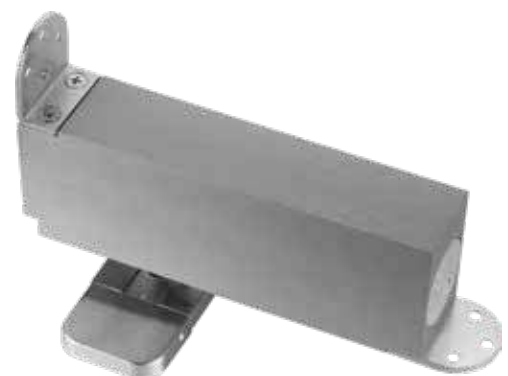

THE ORIGINAL SELF CLOSING PATCH FITTING

OCFH-W-105 STD SSS ₹ 20,100

Suitable door width: 1250mm
 Suitable door thickness: >50mm
 Suitable for External Doors with Power Size 5

FLOOR SPRING

FS-8300 STD STD ₹ 9,350

Double Cylinder Floor Spring for better performance on internal low traffic doors



- Maximum door weight **80kg**
- Tested to : 5,00,000 cycles



FS-8400-S STD STD ₹ 11,550

Cam Action Floor Spring with Closing Force **EN3**
Double Cylinder with **Stronger Spring Inside**



- Super Spring (stronger spring inside)
- Maximum door weight **80kg**
- Tested to : **10,00,000 cycles**

EN 1154 Tested



Scan QR for Installation Video

FS-8400 STD STD ₹ 10,160

Cam Action Floor Spring with Closing Force **EN3**
Double Cylinder (Heavy Duty)



- Maximum door weight **80kg**
- Tested to : 5,00,000 cycles

EN 1154 Tested



FS-8400 BM STD STD ₹ 12,020

Cam Action Floor Spring with Closing Force **EN3**
Double Cylinder (Heavy Duty)



- Maximum door weight **80kg**
- Tested to : 5,00,000 cycles

EN 1154 Tested



FLOOR SPRING

FS-9000 STD STD ₹ 10,780

Cam Action Floor Spring with Closing Force **EN4**
Double Cylinder (Heavy Duty)



- Maximum door weight **120kg**
- Tested to : 5,00,000 cycles

EN 1154 Tested   **120 Kg**
 Weight Carrying Capacity **3 Years***
WARRANTY

FS-9400 STD STD ₹ 11,990

Cam Action Floor Spring with Closing Force **EN4**
Double Cylinder (Heavy Duty)



- Maximum door weight **150kg**
- Tested to : 5,00,000 cycles

EN 1154 Tested   **150 Kg**
 Weight Carrying Capacity **3 Years***
WARRANTY

FS-10400 STD STD ₹ 13,750

Cam Action Floor Spring with Closing Force **EN4**
Double Cylinder (Heavy Duty)



- Maximum door weight **270kg**
- Tested to : 5,00,000 cycles

EN 1154 Tested   **270 Kg**
 Weight Carrying Capacity **3 Years***
WARRANTY

FS-11400 STD STD ₹ 14,850

Power Adjustable Floor Spring for Heavy Wooden / Glass Doors
Ideal for Banquet Halls, **EN 2-6**



- Door weight range **65kg-200kg**
- Power adjustable

65-200 Kg
 Weight Carrying Capacity **3 Years***
WARRANTY

FLOOR SPRING

OFS-5800SD STD STD ₹ 5,940

Single Cylinder Floor Spring for Small Glass Doors, **EN3**



Product Set includes



*Patch fittings will not be sold individually.

Set includes: Floor Spring, Top Patch & Bottom Patch
• Maximum door weight **55kg**



OFH-5500E-TPBPE1 STD STD ₹ 3,850

Single Cylinder Floor Spring for Wood/Aluminium/Framed Doors, **EN2**



Product Set includes Top & Bottom Pivot for Wooden & Aluminium Door



High and Low Adjustment Screw

Maximum door weight **45kg**



OFH-6600-E STD STD ₹ 4,170

Single Cylinder Floor Spring for Wood/Aluminium/Glass Doors, **EN4**



with up & down Adjustment ↑ ↓

Maximum door weight **85kg**



OFS-6400SD+ ₹ 5,940

Single Cylinder Floor Spring for Glass Doors, **EN3**



Product Set includes



*Patch fittings will not be sold individually.

Set includes: Floor Spring, Top Patch & Bottom Patch
Maximum door weight **70kg**



FLOOR SPRING ACCESSORIES

Finish : SSS & Black Matt

OFS-ACC-TPBPE1 STD SSS ₹ 1,441
 Top & Bottom Pivot for
 Wooden/Aluminium Door



OFS-ACC-TP/BP STD SSS ₹ 1,441
 Top & Bottom Pivot
 for Wooden/Aluminium Door



OFS-ACC-GDP SS ₹ 440
 Top Pivot for Patch/Point
 Fitting Doors



OFS-ACC-OP-L/R SS ₹ 1,716
 Offset Pivot Set for
 Wooden/Aluminium Doors



OFS-ACC-MH1 STD SS ₹ 1,300
 Mini Floor Hinge Compatible
 with Patch Fittings



TRANSOM CLOSERS

OTC-7400 STD STD ₹ 13,640
 Transom Mounted Door Closer



Specifications
**Cam action transom door closer
 with closing force EN 2**

- Maximum opening angle 130° both sides
- Maximum door weight 70Kg
- Maximum door width 850mm
- Suitable for framed door



OTC-8400 STD STD ₹ 13,640
 Transom Mounted Door Closer

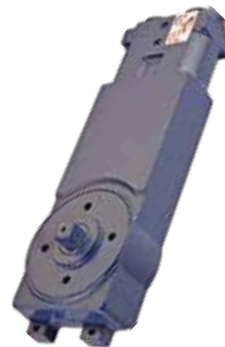

Specifications
**Cam action transom door closer
 with closing force EN 3**

- Maximum opening angle 130° both sides
- Maximum door weight 105Kg
- Maximum door width 950mm
- Suitable for framed door



ACCESSORIES for Transom Mounted Closers (Part of Standard Package)



Bottom Pivot with Bearing



Mounting Bracket for Transom Closer at Spindle Side



Mounting Bracket for Transom Closer at the end



Arm to accept Transom Closer Spindle to be mounted into the channel on door top & secure with blanking tape



OVERHEAD DOOR CLOSERS

Finish : Silver



E Series



5 Lakhs
Cycles Tested

NSK-580-11 STD SILVER ₹ 2,178
OVERHEAD DOOR CLOSER (SCISSOR ARM)
Rack and Pinion Overhead Door Closer with Adjustable closing force EN 1/2
• Maximum door weight: 45kg
• Finish: Silver

45 Kg

Weight Carrying Capacity

NSK-580-E STD SILVER ₹ 1,650
OVERHEAD DOOR CLOSER (SCISSOR ARM)
Rack and Pinion Overhead Door Closer with Adjustable closing force EN 1/2
• Maximum door weight: 45kg
• Finish: Silver

45 Kg

Weight Carrying Capacity

E Series



EN 1154 Tested



5 Lakhs
Cycles Tested

NSK-640-E STD SILVER ₹ 2,299
OVERHEAD DOOR (SCISSOR ARM)
Rack and Pinion Overhead Door Closer with Adjustable closing force EN 3
• Maximum door weight: 60kg
• Finish: Silver

60 Kg

Weight Carrying Capacity

NSK-680 STD SILVER ₹ 2,860
OVERHEAD DOOR CLOSER (SCISSOR ARM)
Rack and Pinion Overhead Door Closer with Adjustable closing force EN 2-4
• Maximum door weight: 80kg
• Finish: Silver/Gold/Brown/Antique Brass

80 Kg

Weight Carrying Capacity

Power Adjustable



EN 1154 Tested



5 Lakhs Cycles Tested

NSK-680A STD SILVER ₹ 2,860
OVERHEAD DOOR CLOSER (SCISSOR ARM)

Rack and Pinion Door Closer with Adjustable closing force EN 2-4

- Maximum door weight: 80kg
- Finish: Silver

80 Kg



EN 1154 Tested



5 Lakhs Cycles Tested

NSK-6825 STD SILVER ₹ 5,060
OVERHEAD DOOR CLOSER (SCISSOR ARM)

Rack and Pinion Door Closer with Selectable closing force EN 3-4

- Maximum door weight: 100kg
- Finish: Silver

100 Kg



EN 1154 Tested



5 Lakhs Cycles Tested

NSK-780 STD SILVER ₹ 7,040
OVERHEAD DOOR CLOSER (SCISSOR ARM)

Rack & Pinion Door Closer with Adjustable closing force EN 2-5

- Maximum door weight: upto 100kg
- Finish: Silver

100 Kg



EN 1154 Tested



5 Lakhs Cycles Tested

NSK-836 BC DA Std. Silver ₹ 10,100
OVERHEAD DOOR CLOSER (SCISSOR ARM)

Rack and Pinion Door Closer with Adjustable closing force EN 3-6

- Maximum door weight: upto 120kg
- Finish: Silver

120 Kg



EN 1154 Tested



5 Lakhs Cycles Tested

NSK-880 STD SILVER ₹ 8,789
OVERHEAD DOOR CLOSER (SCISSOR ARM)

Rack & Pinion Door Closer with Adjustable closing force EN 2/3/4/5

- Maximum door weight: 100Kg
- Finish: Silver

100 Kg



E Series

NSK-980 E TA Light Grey ₹ 4,840
OVERHEAD DOOR CLOSER (TRACK ARM)

Rack and Pinion Door Closer with Adjustable closing force EN 2-4

- Maximum door weight: 80Kg
- Finish: Light Grey

80 Kg



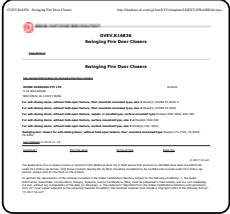
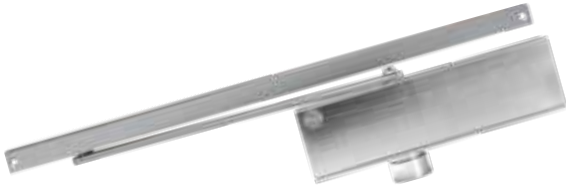

NSK-980 SSS ₹ 4,840
OVERHEAD DOOR CLOSER (TRACK ARM)

Rack and Pinion Door Closer with Adjustable closing force EN 2-4

- Maximum door weight: 80Kg
- Finish: Silver



5 Lakhs
Cycles Tested

80 Kg



Weight Carrying Capacity



NSK-980 BM ₹ 6,710
OVERHEAD DOOR CLOSER (TRACK ARM)

Rack and Pinion Door Closer with Adjustable closing force EN 2-4

- Maximum door weight: 80Kg
- Finish: Black Matt



5 Lakhs
Cycles Tested

80 Kg



Weight Carrying Capacity

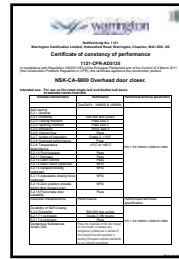

NSK-CA-6800.TA SSS, ₹ 9,900
CAM ACTION OVERHEAD DOOR CLOSER (TRACK ARM)

Overhead Cam Action Door Closer with adjustable closing force EN 2-4

- Maximum door weight: upto 80kg
- Finish: Silver



EN 1154 Tested



5 Lakhs
Cycles Tested



80 Kg
Weight Carrying Capacity

CONCEALED DOOR CLOSERS

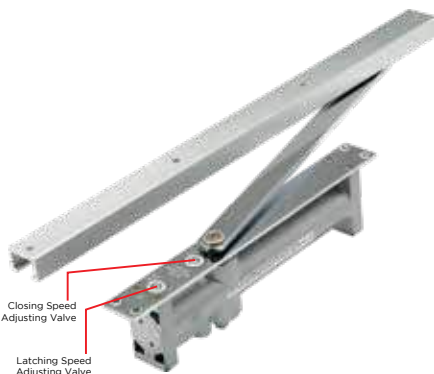

Closing Speed Adjusting Valve
Latching Speed Adjusting Valve

CDC-3800 STD SILVER ₹ 5,610
CONCEALED DOOR CLOSER

Concealed Rack & Pinion Door Closer with EN 3

- Minimum Door Thickness: 38mm
- Maximum door weight: 60kg
- Finish: Silver



5 Lakhs
Cycles Tested



Scan QR Code for Installation Video

60 Kg



Weight Carrying Capacity

E Series



CDC-3800E DGRY ₹ 5,060
CONCEALED DOOR CLOSER

Concealed Rack & Pinion Door Closer with EN 3

- Minimum Door Thickness: 38mm
- Maximum door weight: 60kg
- Finish: Grey

60 Kg



Weight Carrying Capacity

CONCEALED DOOR CLOSERS

Power Adjustable with Back Check

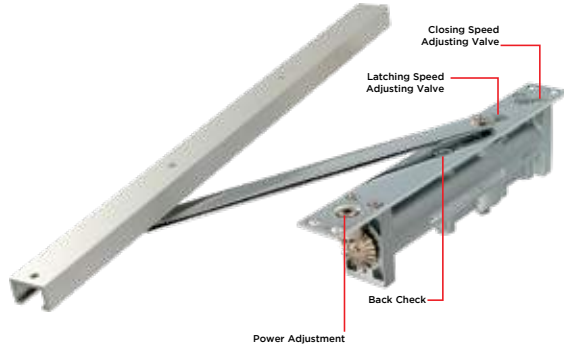

CDC-4800 STD SILVER ₹ 8,635

Concealed Rack & Pinion Door Closer with adjustable value EN 2-4

- Minimum Door Thickness: 42mm
- Maximum door weight: upto 80kg
- Finish: Silver



Power Adjustable

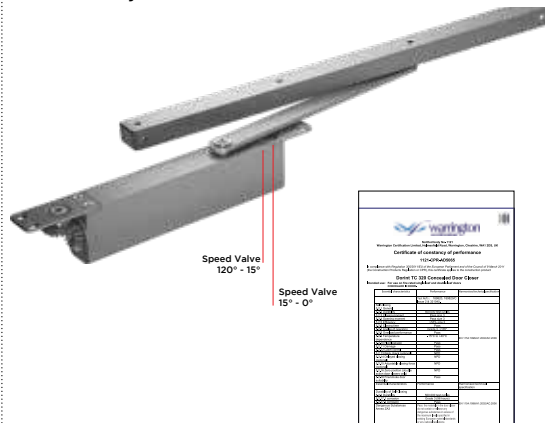

EN 1154 Tested



5 Lakhs Cycles Tested

CDC-CA-6800 STD SILVER ₹ 10,890

Cam Action Concealed Door Closer with Adjustable Closing Force EN 2-4

- Minimum Door Thickness: 41mm
- Maximum door weight: 80kg
- Finish: Silver



ELECTROMAGNETIC DOOR CLOSERS

Available against bulk orders only



NSK-980-EMHO-SA Price on request

Door Closer with Electromagnetic Hold Open Scissor Arm
Finish: SSS



NSK-980-EMHO-SA-S Price on request

Door Closer with Electromagnetic Hold Open Scissor Arm and **Smoke Detector**
Finish: SSS



NSK-980-EMHO-TA STD SS ₹ 16,555

Door Closer with Electromagnetic Hold Open Track Arm
Finish: SSS



NSK-980-EMHO-TA-S STD SS ₹ 22,400

Door Closer with Electromagnetic Hold Open Track Arm and **Smoke Detector**
Finish: SSS

ACCESSORIES FOR OVERHEAD DOOR CLOSERS



ODC-ARM-SS STD SS ₹ 2,893
Stainless Steel Arm for NSK 780 & 880



ODC-ARM-HO-680 ₹ 1,837
Hold Open Arm for NSK 680



ODC-ARM-HO-780/880 STD Silver ₹ 2,607
Hold Open Arm for NSK 780/880



ODC-ACC-PB STD SILVER ₹ 264
Parallel Arm Bracket



NSK-980-COVER SS ₹ 1,595
Stainless Steel Door Closer Cover for NSK 980



ODC-ARM TR-HO-980 SS ₹ 2,079
Track Arm with Hold Open Function for NSK 680/780/880/980 Door Closers



NSK-ACC-780-PLATE STD SILVER ₹ 2,013
Mounting Plate for Glass Door Installation of Door Closer NSK 780



NSK-ACC-980-PLATE STD SILVER ₹ 2,024
Mounting Plate for Glass Door Installation of Door Closer NSK 980

TELESCOPIC SLIDING DOOR SYSTEMS FOR WOODEN AND FRAMED DOORS



Ozone introduces the Wooden Synchronized Manual Telescopic Sliding Door System to achieve maximum clear door opening. Door panels can be stacked on one side in-line with top track and require minimum parking space.

Its ideal applications are in residential and commercial interior spaces as internal partitioning system. For more details, send an enquiry at support@ozone-india.com

Specifications:

- Maximum Width of Panels: **1000mm**
- Maximum Weight of Panels: **90Kg**
- Maximum Thickness of Panels: **35mm**
- Available Track length: **3mtr & 4mtr**
- Finish: Aluminum Anodized



3 PANEL DOOR SLIDING SET:

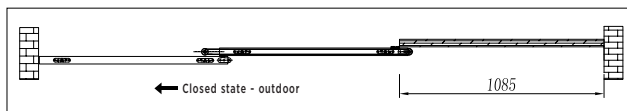

OSL-TW-03 R Std AN ₹ 18,590
Right Hand Opening

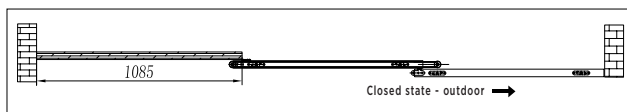

OSL-TW-03 L Std AN ₹ 18,590
Left Hand Opening

4 PANEL DOOR SLIDING SET:

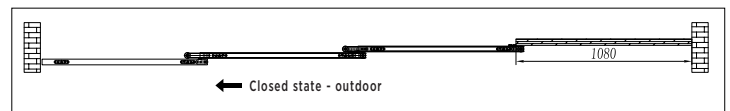

OSL-TW-04 R Std AN ₹ 29,480
Right Hand Opening

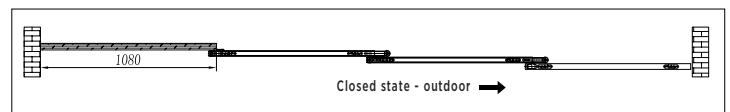

OSL-TW-04 L Std AN ₹ 29,480
Left Hand Opening

TOP TRACK & ACCESSORIES

OSL-TW-Track-ACC-3mtr AN ₹ 22,900/set 3mtr Track with other Accessories	OSL-TW-Track-ACC-4mtr AN ₹ 31,400/set 4mtr Track with other Accessories
---	---



Top Track-2Pcs. Pelmet Cover-2Pcs. SS Rope, 2mtr-1Pc.



Additional Accessories Required For OSL-TW-04 R/L (Four Panels)	
Item Code for 3mtr. track (If clear opening at site is upto 3mtr)	Item Code for 4mtr. track (If clear opening at site is upto 4mtr)
OSL-TGW-Track-3mtr AN (1pc) ₹ 7,450	OSL-TGW-Track-4mtr AN (1pc) ₹ 9,900
OSL-TGW-Rope-2mtr SS (1pc) ₹ 661	OSL-TGW-Rope-2mtr SS (1pc) ₹ 661

OR

PREMIUM MANUAL SLIDING SYSTEMS



Heavy duty **80-150kg** also available



Item Codes:

• OZSL-P-S-SYS STD SSS ₹ 26,840

• OZSL-P-S-Track 2mtr SSS ₹ 16,500



Soft Close

Key Features:

- Soft closing single sliding wooden door
- Suitable for office, kitchen, living room and pocket doors
- Elegant and slim design
- Can be mounted on glass, wall and ceiling
- Internationally patented in Germany as per EN1527 standards
- Roller tested for 100,000 cycles
- Hydraulic soft closing bumper-Tested for 2,00,000 impact cycles
- Energy efficient-prevents AC loss by allowing minimum 5mm gap between sliding & fixed glass
- Adjustable soft closing pulling force for different door weight 40-80kg

Specifications:

- Slim Track Size: 54x58mm
- Door height adjustment +/-3.5mm on carriage and prevent the de-railing of sliding door
- Max. door weight: 40-80kg/ 2carriages
- Aluminium anodised top track
- Finish: SS or brushed clear
- Length: 2mtr(Standard) and 4mtr(Against order)

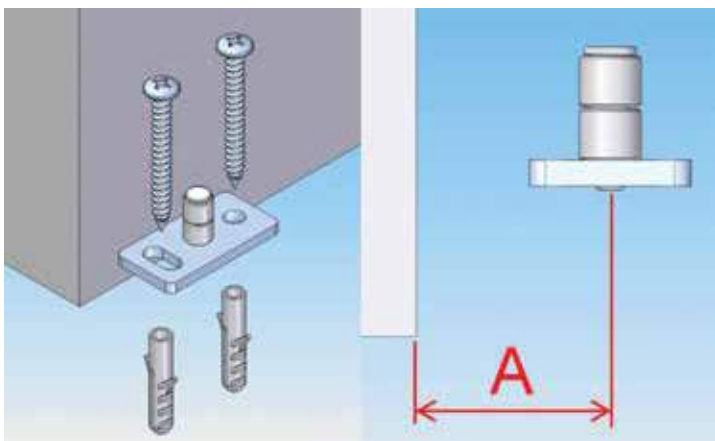

OZ-SD-754 (Floor Guide)

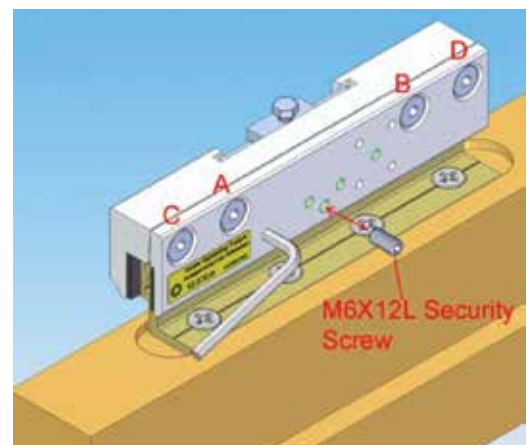

OZ-LYON-101 (Wooden Clamp)

SLIDING SYSTEM FOR WOODEN/FRAMED DOORS



OZ-ESL-WD-11-80 ₹ 1,221
Sliding System Set W/O Track for Single Framed/Wooden Door of **80kg**



OZ-ESL-WD-11-100 ₹ 1,804
Sliding System Set W/O Track for Single Framed/Wooden Door of **100kg**



2Mtr. ₹ 2,050
4Mtr. ₹ 4,090

OZ-ESL-TRACK-E2
Top Track Suitable for ESL-WD-11-80 and WD-11-100 (Available in 2mt & 4mt)

SLIDING SYSTEM FOR WOODEN/FRAMED DOORS FOR HOTEL BATHROOMS



OZ-ESL-WD-22-140 ₹ 3,960
Framed/Wooden Sliding Door System W/O Track for **140kg** Door (Available with Side Wall to Track Holder)



OZ-ESL-TRACK-E3-A1 ₹ 295
OZ-ESL-TRACK-E3-A2 ₹ 595
Wall to Track Connector



2Mtr. ₹ 3,090
4Mtr. ₹ 6,240

OZ-ESL-TRACK-E3
Top Track Suitable for ESL-WD-22-140 (Available in 2mt & 4mt Length)

SOFT CLOSE SLIDING SYSTEM FOR FRAMED/WOODEN DOORS



OZ-ESL-WD-44-SC-N STD STD ₹ 5,060
Soft Close Sliding System with Accessories for Framed/Wooden Door (Single Door) W/O Track Max. Door Weight: **60kg/Door**



2Mtr ₹ 3,440
4Mtr ₹ 7,040

OZ-ESL-TRACK-E5-N 2mtr STD
OZ-ESL-TRACK-E5-N 4mtr STD
Top Track Available in 2mt & 4mt



2Mtr Std ₹ 935

OZ-ESL-FG-BT 2 mtrs STD
Bottom Track

HANDLES FOR WOODEN SLIDING DOORS



SL-WD-HN-10 ₹ 671
Sliding Door Handle for Wooden Door



SL-WD-ACC-11
Lock and Handle for Wooden Sliding Door
PSS ₹ 3,685
SSS ₹ 3,827



OZ-ESL-WD-ACC-22N ₹ 2,145
Mortise Sliding Door Lock

SLIDING FOLDING SYSTEM - 555 FOR FRAMED/WOODEN DOORS



Ozone offers Sliding Folding Partitioning System for wood & framed door panels in different panel configurations. This system is a combination of various stainless steel fittings to enable achieving desired partitioning width and smooth sliding folding movement of panels. Our technical team can help you to create customized options.

Features:

- SS Hinges SS-304
- Aluminium top & bottom with anodized finish
- Nylon hanger/roller

Specifications:

- Max opening: 8mtr
- Max panel weight: 80kg
- Max panel height: 3000mm
- Max panel width: 1000mm
- Min panel thickness: 35mm



Scan QR for Installation Video

FITTINGS (Images only for reference)



Note:- For ordering purpose refer the table on next page.

Product Kit Components:

How to Order						
	SL-WSFS-555-2 2 Panel Sliding Folding set	SL-WSFS-555-3 3 Panel Sliding Folding set	SL-WSFS-555-4 4 Panel Sliding Folding set	SL-WSFS-555-5 5 Panel Sliding Folding set	SL-WSFS-555-6 6 Panel Sliding Folding set	SL-WSFS-555-8 8 Panel Sliding Folding set
SL-WSFS-555 Sliding Folding System	2 panel 	3 panel 	4 panel 	5 panel 	6 panel 	8 panel
MRP	₹ 31,200	₹ 43,500	₹ 57,200	₹ 68,700	₹ 81,400	₹ 10,5900
Pivot set (A) 	1 set	1 set	1 set	1 set	1 set	1 set
Offset hinge set (B) & (D) 	-	1 set	2 set	1 set	2 set	1 set
Intermediate carrier set (C) 	-	1 set	1 set	2 set	2 set	3 set
Right/ Left carrier set (E) 	1 set	-	1 set	-	1 set	1 set
Center hinge set (F) 	1 set	-	-	1 set	1 set	2 set
Drop bolt (F) 	1 No	1 No	2 Nos	2 Nos	3 Nos	4 Nos
 Top Track 2M Bottom Track 2M	1 set	-	2 set	1 Set	-	-
 Top Track 3M Bottom Track 3M	-	1 set	-	1 set	2 set	-
 Top Track 4M Bottom Track 4M	-	-	-	-	-	2 set



BLACK MATT
Architectural Hardware

FLOOR SPRING & DOOR CLOSER

Finishes:  **BM**  **GM**  **AB**



FS-8400-BM STD STD ₹ 12,020
Cam Action Floor Spring with Closing Force **EN3**
Double Cylinder (Heavy Duty)

- Maximum door weight **80Kgs.**
- Tested to 5,00,000 cycles



EN 1154 Tested



NSK-980 BM ₹ 6,710
OVERHEAD DOOR CLOSER (TRACK ARM)
Rack and Pinion Door Closer with Adjustable closing force **EN 2-4**

- Maximum door weight: 80Kg
- Finish: Black Matt



5 Lakhs
Cycles Tested

80 kg



Weight Carrying Capacity

MORTISE HANDLE



For Narrow Style Doors

OMH-11LN BM ₹ 1,749
Mortise Handle for Narrow Style Doors
Material: Stainless Steel
Grade: 304
Finish: BLACK MATT

PIVOT HINGES FOR SWING GLASS DOORS



OZ-PGDH STD BM ₹ 4,428
Pivot Hinge Set
Finish: Black Matt

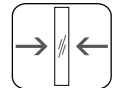

Glass Thickness **08-10mm**



Door Width **1000mm**



60 Kg
Weight Carrying Capacity

GLASS DOOR HANDLE



OGH-55 -32x457MM BM ₹ 3,163
Glass Door Handle



OPF-2 STD BM ₹ 2,467
Top Patch



OPF-3 STD BM ₹ 2,467
Bottom Patch



OPL-1 STD BM ₹ 3,858
Corner Patch Lock with Strike Plate



OFS-ACC-GDP-S STD BM ₹ 506
Top Pivot

Finishes:  **BM**  **GM**  **AB**

THE ORIGINAL SELF CLOSING PATCH FITTING



• Power Adjustable

Finishes: 
BM



OCFH-100 STD BM ₹ 16,570

- Max door width: 950mm
- Suitable door thickness: 8-12mm
- Tested as per: EN1154
- Ideal for Internal Doors

OCFH-135 STD BM ₹ 22,640

- Max door width: 1250mm
- Suitable door thickness: 10-15mm
- Ideal for Internal & External Doors

THE ORIGINAL SELF CLOSING PATCH FITTING

S Series
Premium Collection of
Architectural Hardware



OCFH-100S STD BM ₹ 18,340

Features:

- Cover & base plate in high grade Stainless Steel 316
- Corrosion resistant
- 3 years warranty
- Compliant with EN 1154 standard

Specification:

- Quick and easy installation with just 4 fasteners
- EN-3 for interior & exterior applications
- Suitable door weight: Max 100kg
- Suitable door width: 750-1000mm
- Suitable door thickness: 8-12mm
- Maximum opening 150° and controlled 135°
- Durability-500,000 Cycles tested
- Ambient temperature: -20°C to +50°C

OPF-2 PLUS STD BM ₹ 3,669

Top Patch For The Original Self Closing Patch Fitting

Specifications

- 1mm thick cover plate in high grade Stainless Steel 316
- Corrosion resistant
- Compatible with Ozone OFS-ACC-GDP-S and OPF-1 PLUS

OFS-ACC-GDP STD BM ₹ 506

Top Pivot

Specifications:

- Top pivot with 15mm diameter pin
- Wear-resistant SS 316 pivot pin
- Pivot held in overhead structure
- High grade SS 316 Patch fitting
- Finish: BM



MAGNETIC STRIKE LOCKS FOR FRAMELESS GLASS DOORS

S Series
Premium Collection of Architectural Hardware

11S Series

For MRP refer below table*

For Frameless Glass Doors
11S Series



Square Glass door Lock with Magnetic Strike Plate
Finish: BM
For Product Codes refer below table

For Bathroom Frameless Glass Doors
22S Series



Square Bathroom Glass Door Lock With Magnetic Strike Plate (With WC Indicator)
Finish: BM
For Product Codes refer below table

Optional accessories:



OZ-MGL-11/22 S-SB1 STD BM ₹ 4,681
Strike Box for Glass to Glass Application
Finish: BM

OZ-MGL-11/22 S-SPI STD BM ₹ 1,455
Strike Plate for Glass to Wall Application
Finish: BM

***How to order OZ-MGL-11S / OZ-MGL-22S**

Product Code	Description	PLC Reference-DIN Outside View	
₹ 11,132 OZ-MGL-22S-I STD BM	Inward-One side knob other side Coin Slot for RH/LH opening	Left Hand Inward (DIN)	Right Hand Inward (DIN)
₹ 11,891 OZ-MGL-11S-I-K2N Std BM	Inward-One side knob other side Coin Slot for RH/LH opening		
₹ 11,132 OZ-MGL-22S-O STD BM	Outward-One side knob other side Coin Slot for RH/LH opening	Left Hand Outward (DIN)	Right Hand Outward (DIN)
₹ 11,891 OZ-MGL-11S-O-K2N Std BM	Outward-One side knob other side Coin Slot for RH/LH opening		
₹ 11,891 OZ-MGL-11S-K2K Std BM		Universal	

*Note:- Optional Accessories to be ordered separately as per application requirement.

SHOWER HINGES



Finish : Black Matt



₹ 2,550

OSSH-11-ED STD BM
Wall to Glass Hinge



₹ 4,023

OSSH-22-ED STD BM
Glass to Glass Hinge 180°



₹ 4,288

OSSH-33-ED STD BM
Glass to Glass Hinge 135°



₹ 4,516

OSSH-44-ED STD BM
Glass to Glass Hinge 90°



₹ 2,454

OSSH-55-ED STD BM
Wall to Glass Fixed Bracket

GLASS CONNECTORS



Finish : Black Matt



₹ 1,012

OGC-111-ED STD BM
Wall to Glass Connector



₹ 1,442

OGC-222-ED STD BM
Glass to Glass Connector 135°



₹ 1,316

OGC-333-ED STD BM
Glass to Glass Connector 90°



₹ 1,050

OGC-444-ED STD BM
Wall to Glass Connector 90°



₹ 1,442

OGC-555-ED STD BM
Glass to Glass Connector 180°

SHOWER HINGE



OSH-OFS-1S STD BM ₹ 4,795
Wall to Glass off-set Hinge

TOWEL BAR WITH HANDLE



Finishes:  
BM GP

OGH-TB-1S STD BM ₹ 5,123
Towel Bar with Handle (Ø19 mm)

EDGE LINE KNIGHT HEAD FITTINGS



OSSKH-1-ED STD BM ₹ 683
Wall to Track Connector



OSSKH-2-ED STD BM ₹ 750
Track to Glass Connector



OSSKH-3-ED STD BM ₹ 820
Glass to Track end Connector
Track to Track 90° Connector



2mtr. BM ₹ 3,087

OSSKH-ACC-25T-ED 1.65mtr. BM
OSSKH-ACC-25T-ED 2mtr. BM
Connector Track

GLOSSARY

Finishes:



SSS | Satin Stainless Steel



BM | Black Matte



PSS | Polished Stainless Steel



PG | Polished Gold



CP | Chrome Polished



GP | Gold Plated



CS | Chrome Silver



GM | Gold Matt



AN | Anodized Nickel



RG | Rose Gold



AB | Antique Bronze

Pictures of Few of the Prestigious Projects:



Omaxe Mall



Ambience Tower,
Gurgaon



Maruti Suzuki Nexa,
(Across India showrooms)



St. Johns Auditorium



Occura Eye Hospital,
Ahmedabad



Kolkata Airport



Mumbai Airport



Bus Queue Shelters
Delhi, Allahabad, Jaipur,
Patna & Chandigarh



Erricon, Pune

Only few out of our huge client base have been mentioned. We look forward to service every project and household.

Pictures of Few of the Prestigious Projects:



Unity One Mall, Delhi



Amagi Media, Bengaluru



KPMG, Bengaluru



IIT Indore



NBCC Building



Occura Eyecare Hospital Ahmedabad



Metro Central Mall, Kolkata



ZEE TV, Noida



DLF Camellias, Gurugram

Disclaimer: Product specifications, information & visuals shown in this catalogue are illustrative in nature, the customers are advised to kindly check technical specifications & details before placing order. Company will not be liable for any such loss to customers for technically unsuitable/unfit product. Ozone Overseas reserves the right to change or modify the specifications any time without notice/information. The Company shall only be responsible for defects covered under the product warranty and shall in no way be accountable for any defects (including but not limited to packaging, installation instructions, manuals, specification instructions and care and maintenance instructions), after the delivery of goods to the Customer. All risk and obligations in the goods and products delivered by the Company passes to the Purchaser immediately upon delivery to the Purchaser.

International Offices



Melbourne, Australia

32-40 Tarnard Drive, Braeside VIC 3195,
Phone : +61 1300 088 225
Mobile : +61 (0) 4 301 301 02
e-mail : info@ozoneaustralia.com.au
website : www.ozoneaustralia.com.au

Corporate Office



New Delhi

H-40, Bali Nagar,
New Delhi-110 015
T: +91-11-45576677 (30 Lines)
Fax: +91-11-45576699
e-mail: ozone@ozone-india.com

Works

Ozone Metallics Pvt. Ltd.
Trilokpur Road, Kheri,
Nahan District-Sirmour
Kala Amb
Himachal Pradesh



For Hardware Solutions:

New Delhi*

1/122, Timber Mkt., Kirti Nagar, New Delhi
T : +91-11-49124400, 01
e-mail: delhihub@ozone-india.com

For Security Solutions:

Gurugram*

#548 Udyog Vihar, Phase 5,
Sector 19, Gurugram, Haryana-122016
Ph : +91-124-4961164, 65

Branch Offices

Ahmedabad

407, 4th Floor, Shivalik Abaise,
Opp. Shell Petrol Pump, Prahaladnagar,
Ahmedabad - 380051
T : +91-079-29706789

Bengaluru*

No. 424, 2nd Floor, Above HDFC Bank,
Passport Office Road, 6th block ,
Koramangala, Bengaluru - 560034
T: +91-80-41207539
e-mail: blrhub@ozone-india.com

Chandigarh

SCO 907, NAC Mani Majra
Near Solitaire Hotel,
Chandigarh - 160101
Mob: +91-9316001154

Chennai*

1-A, Jasoda Apartments,
No: 12, Ground Floor, Bank Street,
Kilpauk, Chennai - 600010.
T: 044-43802063
e-mail: chennaihub@ozone-india.com

Hyderabad

Unit # 704, 7th Floor, Shangrila Plaza,
Road No. 2, Banjara Hills,
Hyderabad - 500034

Indore

503, B Block, Prakrati Corporate,
Y N Road, Indore - 452001
Mob: +91-9589589902

*Also Operation Office

Jaipur

27, 5th Floor, Mahima Trinity Mall, Swej Farm,
New Sanganer Road, Jaipur-302019
T : +91-141-2294261
e-mail: jaipurhub@ozone-india.com

Kolkata

4 Govt Place, 4th floor, Room No:- 4H
Delta House. Kolkatta - 700001
Mob: +91-9831176481

Lucknow*

Akash Apartment-2 1st Floor Gokhale Marg
Opp. IFFCO, Lucknow-226001
T : +91-0522-4109647
Mob: 9794970000

Mumbai

The Avenue, 607,
Near Waterstones Hotel, Int. Airport Road,
Marol, Andheri (E), Mumbai - 400059
T : +91-22-28306453
Mob: +91-7045775977

Pune

#105, 1st Floor, Suyog Center
Market Yard, Gultekdi, Pune - 411037
Mob: +91-9974180155

Surat

201, Luxuria Business Hub, Nr.V.R.Mall, Surat-
Dumas Road, New Magdalla Road,
Surat - 395007
Mob: +91-9724009921

Download Ozone India App



Visit Website



Android



iOS

www.ozone-india.com | India Customer Care: +91-9310012300 | customercare@ozone-india.com





Kitchen & Furniture Fittings Wardrobe Sliding Systems

Edition #1

MRP w.e.f 15th June `21

Download Ozone India App



Android



iOS

Ozone continues with the concept of "Total Vision" to create transparent & elegant commercial spaces. Every fitting in our architectural glass hardware range is designed to meet the concept of "Total Vision".

Ozone, a leading name in architectural hardware domain, offers high quality architectural hardware & safety solutions worldwide. It has achieved many accolades internationally for its innovative and technologically advanced products and solutions. Its manufacturing capability enables it to offer turnkey projects of all sizes. The design team includes architects, product designers & structural engineers who innovate and support the customers and project managers. Offering more than 3000 products from its portfolio intelligently divided into 09 broad categories based on application. Ozone has been continuously innovating to offer best solutions complying with international norms of safety & quality.

Manufacturing Capability

Our state-of-the-art manufacturing units located in India and overseas enable us to provide Standard and Customized Architectural Hardware & Infrastructural Solutions in Stainless Steel.

Our strengths are:

- Over 18 years extensive experience of operating in Architectural Hardware Industry and Digital Safes
- Dedicated and technically experienced team
- Advanced automated machines & tools
- Ability to undertake OEM & ODM projects
- In-house R & D set-up for offering right mix of design, cost, quality and delivery
- Project support & customer service team



CNC Laser Cutting Machine

AUTOMATED STATE-OF-THE-ART Manufacturing Facility

Our manufacturing units are equipped with the latest and technologically advanced machines. These comprise CNC laser cutting machine, CNC water jet cutting machine, CNC shearing machine, robotic welding & automatic polishing machines that enable us to manufacture all types of hardware fittings in stainless steel material and finish, standard as well as customized, as per international safety & quality norms.



Scan QR for
Manufacturing Facility

Location:

Kala Amb
Himachal Pradesh
India



VMC (Vertical Machine Center)

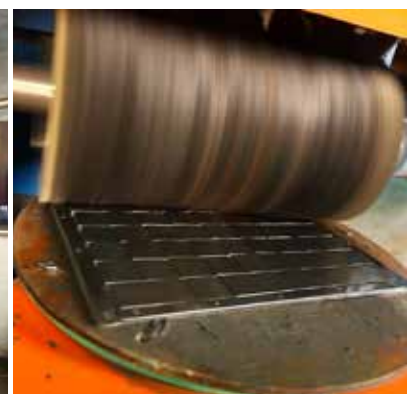

Polishing Machine



CNC Punching Machine



Welding Centre

Ozone Product SBUs

Our product portfolio offers more than 3000 SKUs, intelligently divided into 09 broad categories. We constantly endeavour to innovate products for offering better solutions that deliver enhanced value to our discerning customers world over such as architects, builders, contractors, fabricators, specifiers, consultants and home owners.

OZONE HARDWARE



OZONE METALSCAPES

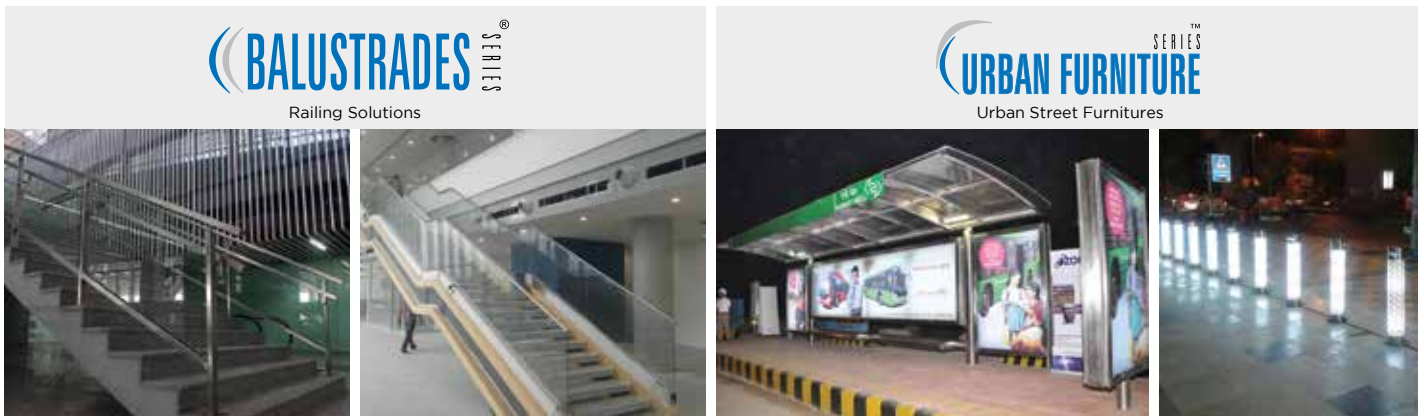

OZONE SECUTECH



INDEX...

	Page No.
Ball Bearing Drawer Slides	1-3
Auto-Close Concealed Hinges	4-7
Double Wall Drawer Systems	8-10
Kitchen Storage Organizers	11-13
Drawer Organizers and Accessories	14-15
Roller Shutters / Cabinetry Support Accessories	16
Cabinet Lift-Up Systems	17-18
Bed Fittings	19-20
Aluminium Frame & Handle Profiles	21
Joinery Accessories	22
Furniture Locks	23-24
Digital Furniture Locks	25-30
Wardrobe Sliding Systems	31-37



**Roller
Shutter System**



**Undermount
Push Open Drawer Slides**



**Corner
Organizer**



**Sleek Ergotec
Drawer System**

Complete Kitchen Solution

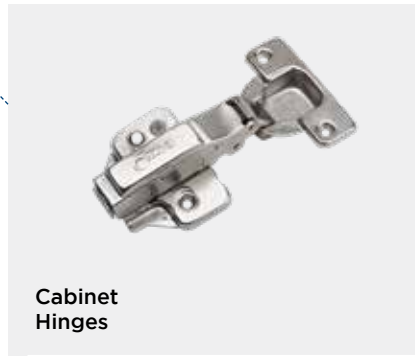

Cabinet Hinges



Aluminium Frame Profiles



Soft Close Lift-Up Systems



Pantry Unit



SS 304 Full Extension Ball Bearing Slides



Crockery Organizers

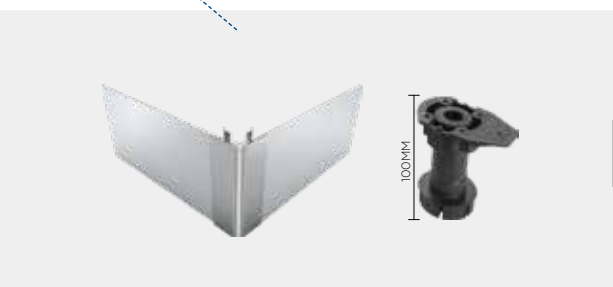

Aluminium Skirting & Cabinet Legs



Cutlery Organizers



Kitchen Bins

E-SERIES BALL BEARING SLIDES



- Full Extension
- Weight Carrying Capacity: **40kg**
- Finishes Available: **Zinc & Black**

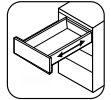

Item Code	MRP	Description
OBBS-4511-E 250mm-10" Zinc	₹ 264	10" Full Extension Drawer Slide
OBBS-4511-E 300mm-12" Zinc	₹ 308	12" Full Extension Drawer Slide
OBBS-4511-E 350mm-14" Zinc	₹ 369	14" Full Extension Drawer Slide
OBBS-4511-E 400mm-16" Zinc	₹ 402	16" Full Extension Drawer Slide
OBBS-4511-E 450mm-18" Zinc	₹ 451	18" Full Extension Drawer Slide
OBBS-4511-E 500mm-20" Zinc	₹ 495	20" Full Extension Drawer Slide
OBBS-4511-E 550mm-22" Zinc	₹ 594	22" Full Extension Drawer Slide



- Full Extension
- Weight Carrying Capacity: **35kg**
- Finishes Available: **Zinc & Black**

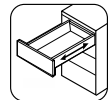

Item Code	MRP	Description
OBBS-4511-E35 200mm-8" Zinc	₹ 187	8" Full Extension Drawer Slide
OBBS-4511-E35 250mm-10" Zinc	₹ 233	10" Full Extension Drawer Slide
OBBS-4511-E35 300mm-12" Zinc	₹ 280	12" Full Extension Drawer Slide
OBBS-4511-E35 350mm-14" Zinc	₹ 326	14" Full Extension Drawer Slide
OBBS-4511-E35 400mm-16" Zinc	₹ 373	16" Full Extension Drawer Slide
OBBS-4511-E35 450mm-18" Zinc	₹ 420	18" Full Extension Drawer Slide
OBBS-4511-E35 500mm-20" Zinc	₹ 465	20" Full Extension Drawer Slide
OBBS-4511-E35 550mm-22" Zinc	₹ 513	22" Full Extension Drawer Slide

STANDARD BALL BEARING SLIDES

- Full Extension
- Weight Carrying Capacity: **45kg**
- Finishes Available: **Zinc & Black**

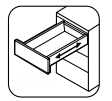

Item Code	MRP	Description
OBBS-4511 200mm-8" Zinc	₹ 275	8" Ball Bearing Drawer Slide
OBBS-4511 250mm-10" Zinc	₹ 325	10" Ball Bearing Drawer Slide
OBBS-4511 300mm-12" Zinc	₹ 380	12" Ball Bearing Drawer Slide
OBBS-4511 350mm-14" Zinc	₹ 435	14" Ball Bearing Drawer Slide
OBBS-4511 400mm-16" Zinc	₹ 473	16" Ball Bearing Drawer Slide
OBBS-4511 450mm-18" Zinc	₹ 550	18" Ball Bearing Drawer Slide
OBBS-4511 500mm-20" Zinc	₹ 605	20" Ball Bearing Drawer Slide
OBBS-4511 550mm-22" Zinc	₹ 682	22" Ball Bearing Drawer Slide
OBBS-4511 600mm-24" Zinc	₹ 748	24" Ball Bearing Drawer Slide
OBBS-4511 650mm-26" Zinc	₹ 820	26" Ball Bearing Drawer Slide
OBBS-4511 700mm-28" Zinc	₹ 875	28" Ball Bearing Drawer Slide
OBBS-4511 750mm-30" Zinc	₹ 946	30" Ball Bearing Drawer Slide
OBBS-4511 900mm-36" Zinc	₹ 1,221	36" Ball Bearing Drawer Slide

SOFT CLOSE BALL BEARING SLIDES

- Soft Close
- Full Extension
- Weight Carrying Capacity: **45kg**
- Finish Available: **Zinc**



Item Code	MRP	Description
OBBS-4511 SC 300mm-12" Zinc	₹ 655	12" Full Extension Soft Close Drawer Slide
OBBS-4511 SC 350mm-14" Zinc	₹ 737	14" Full Extension Soft Close Drawer Slide
OBBS-4511 SC 400mm-16" Zinc	₹ 864	16" Full Extension Soft Close Drawer Slide
OBBS-4511 SC 450mm-18" Zinc	₹ 968	18" Full Extension Soft Close Drawer Slide
OBBS-4511 SC 500mm-20" Zinc	₹ 1,073	20" Full Extension Soft Close Drawer Slide
OBBS-4511 SC 550mm-22" Zinc	₹ 1,144	22" Full Extension Soft Close Drawer Slide

PUSH OPEN BALL BEARING SLIDES

- Push Open
- Full Extension
- Weight Carrying Capacity: **35kg**
- Finish Available: **Zinc**

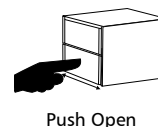

Item Code	MRP	Description
OBBS-4511-PO 350mm 14" Zinc	₹ 721	14" Full Extension Drawer Slide
OBBS-4511-PO 400mm 16" Zinc	₹ 792	16" Full Extension Drawer Slide
OBBS-4511-PO 450mm 18" Zinc	₹ 842	18" Full Extension Drawer Slide
OBBS-4511-PO 500mm 20" Zinc	₹ 897	20" Full Extension Drawer Slide
OBBS-4511-PO 550mm 22" Zinc	₹ 996	22" Full Extension Drawer Slide
OBBS-4511-PO 600mm 24" Zinc	₹ 1,073	24" Full Extension Drawer Slide

SS 304 FULL EXTENSION BALL BEARING SLIDES



- Full Extension
- Weight Carrying Capacity: **45kg**
- Finish Available: **Stainless Steel**

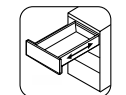

SS 304 Fixing Screws (12 No's) provided with packing

Item Code	MRP	Description
OBBS-4511-304S 350mm-14" SS	₹ 1,375	14" Full Extension Ball Bearing Slide
OBBS-4511-304S 400mm-16" SS	₹ 1,496	16" Full Extension Ball Bearing Slide
OBBS-4511-304S 450mm-18" SS	₹ 1,661	18" Full Extension Ball Bearing Slide
OBBS-4511-304S 500mm-20" SS	₹ 1,804	20" Full Extension Ball Bearing Slide
OBBS-4511-304S 550mm-22" SS	₹ 2,035	22" Full Extension Ball Bearing Slide

HEAVY DUTY BALL BEARING SLIDES

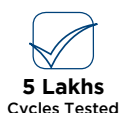

- Full Extension
- Weight Carrying Capacity: **100kg**
- Finish Available: **Zinc**

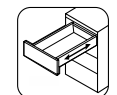

Item Code	MRP	Description
OBBS-FE-100HD 750mm-30" Zinc	₹ 2,398	30" Full Extension Heavy Duty Ball Bearing Slides
OBBS-FE-100HD 900mm-36" Zinc	₹ 2,915	36" Full Extension Heavy Duty Ball Bearing Slides

UNDERMOUNT SOFT CLOSE SLIDES FOR WIRE BASKET

- Soft Close
- Full Extension
- Weight Carrying Capacity: **35kg**
- Finish Available: **Zinc**



Accessories



Set of 8 Pcs.

Item Code	MRP	Description
OE-UMS-SC-FE-11 450mm-18" Zinc	₹ 1,782	18" Full Extension Soft Close Drawer Slide
OE-UMS-SC-FE-11 500mm-20" Zinc	₹ 1,903	20" Full Extension Soft Close Drawer Slide

UNDERMOUNT SOFT CLOSE SLIDES

- Soft Close
- Full Extension
- Weight Carrying Capacity: **35kg**
- Finish Available: **Zinc**



Scan QR for Installation Video



Locking Device (L)



Locking Device (R)

Item Code	MRP	Description
OE-UMS-SC-FE-D 300mm-12" Zinc	₹ 1,485	12" Full Extension Soft Close Drawer Slide
OE-UMS-SC-FE-D 350mm-14" Zinc	₹ 1,606	14" Full Extension Soft Close Drawer Slide
OE-UMS-SC-FE-D 400mm-16" Zinc	₹ 1,672	16" Full Extension Soft Close Drawer Slide
OE-UMS-SC-FE-D 450mm-18" Zinc	₹ 1,782	18" Full Extension Soft Close Drawer Slide
OE-UMS-SC-FE-D 500mm-20" Zinc	₹ 1,903	20" Full Extension Soft Close Drawer Slide
OE-UMS-SC-FE-D 550mm-22" Zinc	₹ 1,958	22" Full Extension Soft Close Drawer Slide
OE-UMS-SC-FE-D 600mm-24" Zinc	₹ 2,079	24" Full Extension Soft Close Drawer Slide

UNDERMOUNT PUSH OPEN SLIDES

- Push Open
- Partial Extension Slide
- Weight Carrying Capacity: **25kg**

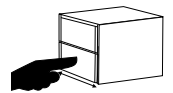

Locking Pin

Item Code	MRP	Description
OZ-CR-SE-PO 300mm-12" Zinc	₹ 1,309	12" Partial Soft Close Drawer Slide
OZ-CR-SE-PO 350mm-14" Zinc	₹ 1,309	14" Partial Soft Close Drawer Slide
OZ-CR-SE-PO 400mm-16" Zinc	₹ 1,375	16" Partial Soft Close Drawer Slide
OZ-CR-SE-PO 450mm-18" Zinc	₹ 1,408	18" Partial Soft Close Drawer Slide
OZ-CR-SE-PO 500mm-20" Zinc	₹ 1,474	20" Partial Soft Close Drawer Slide
OZ-CR-SE-PO 550mm-22" Zinc	₹ 1,496	22" Partial Soft Close Drawer Slide
OZ-CR-SE-PO 600mm-24" Zinc	₹ 1,551	24" Partial Soft Close Drawer Slide

AUTO-CLOSE SLIDE ON HINGE



E Series

- Opening Angle: 110°
- Door Thickness: 14-21mm



EC351-SO-A2S C=0 SS ₹ 86



EC351-SO-B2S C=8 SS ₹ 90



EC351-SO-C2S C=15 SS ₹ 92



OEC451-SO-A2S C=0 SS ₹ 169



OEC451-SO-B2S C=8 SS ₹ 175



OEC451-SO-C2S C=15 SS ₹ 179

- Opening Angle: 110°
- Door Thickness: 14-22mm

SCREW ON AUTO-CLOSE CONCEALED HINGE

Fixing Screws are provided with all hinges

- Screw on
- Opening Angle: 95°
- Door Thickness: 17-21mm



EC351-A2S C=0 SS ₹ 105



EC351-B2S C=8 SS ₹ 109



EC351-C2S C=15 SS ₹ 109

SCREW ON AUTO-CLOSE CONCEALED HINGE WITH 4 HOLES MOUNTING PLATE

Fixing Screws are provided with all hinges

- Screw on
- Opening Angle: 95°
- Door Thickness: 17-21mm



EC351-A-4S C=0 SS ₹ 109



EC351-B-4S C=8 SS ₹ 116



EC351-C-4S C=15 SS ₹ 116



Fixing Screws are provided with all hinges on this page

THICK DOOR AUTO-CLOSE CONCEALED HINGE

- Screw On
- Opening Angle: **95°**

- Door Thickness: **25-30mm**



EC401.A.2S C=0 SS ₹ 248



EC401.B.2S C=8 SS ₹ 253



EC401.C.2S C=15 SS ₹ 259

CLIP ON AUTO-CLOSE CONCEALED HINGE

- Clip on
- Opening Angle: **95°**

- Door Thickness: **17-21mm**



OEC476-A2S (0°) ₹ 193



OEC476-B2S (8°) ₹ 198



OEC476-C2S (15°) ₹ 209

AUTO SOFT-CLOSE CONCEALED HINGE

- Soft Close
- Clip on

- Opening Angle: **95°**
- Door Thickness: **17-21mm**



OEC-451-A2S-SC (0°) ₹ 319



OEC-451-B2S-SC (8°) ₹ 330



OEC-451-C2S-SC (15°) ₹ 330

AUTO SOFT-CLOSE HINGE WITH 04 HOLES MOUNTING PLATE

- Soft Close
- Clip on

- Opening Angle: **105°**
- Door Thickness: **17-21mm**



OEC-451-A4S-SC (0°) ₹ 330



OEC-451-B4S-SC (8°) ₹ 341



OEC-451-C4S-SC (15°) ₹ 341



Fixing Screws are provided with all hinges on this page

3D AUTO SOFT-CLOSE CONCEALED HINGE

- 3D Adjustable Even Vertical Adjustment Possible
- Soft Close
- Clip on
- Opening Angle: **100°**
- Door Thickness: **17-21mm**



OEC-451-A2S-SC 3DA Std ₹ 363



OEC-451-B2S-SC 3DA Std ₹ 380



OEC-451-C2S-SC 3DA Std ₹ 380

THICK DOOR AUTO SOFT-CLOSE CONCEALED HINGE

- Soft Close
- Clip on
- Opening Angle: **95°**
- Door Thickness: **25-30mm**



OEC-501-A2S-SC (0°) ₹ 363



OEC-501-B2S-SC (8°) ₹ 380



OEC-501-C2S-SC (15°) ₹ 380

WIDE OPENING AUTO-CLOSE CONCEALED HINGE

- Screw On
- Opening Angle: **165°-180°**
- Door Thickness: **18-22mm**



OEC352-A2S C-0 SS ₹ 429



OEC352.B.2S C=8 SS ₹ 440



OEC352.C.2S C=15 SS ₹ 446

WIDE OPENING AUTO-SOFT CLOSE CONCEALED HINGE

- Soft Close
- Clip on
- Opening Angle: **170°**
- Door Thickness: **14-24mm**



OEC-170-SC-A2S (0°) ₹ 869



OEC-170-SC-B2S (8°) ₹ 792



OEC-170-SC-C2S (15°) ₹ 803

CLIP ON AUTO-CLOSE CONCEALED HINGE WITH 02 HOLES MOUNTING PLATE



Fixing Screws are provided with all hinges on this page

- Screw On
- Opening Angle: 95°

- Door Thickness: 17-21mm



EC351-A2S-CO C=0 Std ₹ 96



EC351-B2S-CO C=8 Std ₹ 100



EC351-C2S-CO C=15 Std ₹ 102

AUTO-CLOSE SLIDE ON HINGE WITH 04 HOLES MOUNTING PLATE



- Clip on
- Opening Angle: 110°

- Door Thickness: 14-21mm



EC351-SO-A4S C=0 SS ₹ 89



EC351-SO-B4S C=8 SS ₹ 95



EC351-SO-C4S C=15 SS ₹ 97

AUTO-CLOSE SLIDE ON HINGE WITH 04 HOLES MOUNTING PLATE



- Clip on
- Opening Angle: 110°

- Door Thickness: 14-21mm



OEC-451-SO-A4S-SC C=0 Std ₹ 174



OEC-451-SO-B4S-SC C=8 Std ₹ 180



OEC-451-SO-C4S-SC C=15 Std ₹ 184

BLIND CORNER HINGE



OEC-451-G2S-SC ₹ 682

SPECIAL OPENING AUTO-CLOSE CONCEALED HINGE (PIE)



Fixing Screws are provided with all hinges on this page

- Special Opening

- Opening Angle: **95°**
- Door Thickness: **14-22mm**

30° Opening



OEC35.F.2S Standard SS ₹ 143

45° Opening



OEC35.E.2S Standard SS ₹ 193

90° Opening



OEC35.G.2S Standard SS ₹ 226

PIE HINGE



OEC35.H.2S Standard SS ₹ 264

ERGOTEC™ STANDARD DRAWER SYSTEM KIT



SOFT CLOSE

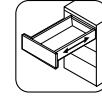

FULL EXTENSION



WT. CARRYING CAPACITY



DUAL-SYNCHRO

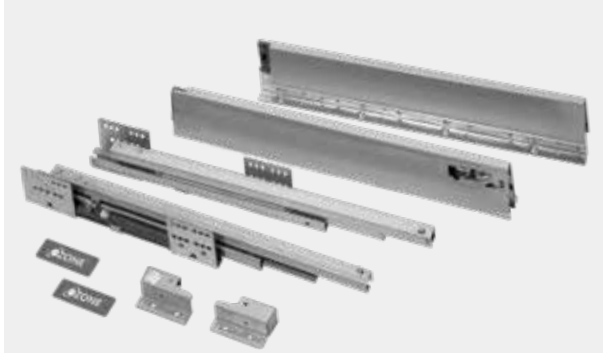

Item Code & MRP Table

How to Order		
Item Code	MRP	Item Description & qty
OE-DWDS-MG 84x350MM	₹ 3,135	System for 350mm(14")
OE-DWDS-W/O-BB-MG 350mm	₹ 2,948	Metal walls & L/R sliding channel-350mm (SET)
OE-DWDS-ACC-BB MG 84mm	₹ 237	Back brackets-84mm (1PAIR)
OE-DWDS-MG 84x400MM	₹ 3,245	System for 400mm(16")
OE-DWDS-W/O-BB-MG 400mm	₹ 3,025	Metal walls & L/R sliding channel-400mm (SET)
OE-DWDS-ACC-BB MG 84mm	₹ 237	Back brackets-84mm (1PAIR)
OE-DWDS-MG 84x450MM	₹ 3,410	System for 450mm(18")
OE-DWDS-W/O-BB-MG 450mm	₹ 3,190	Metal walls & L/R sliding channel-450mm (SET)
OE-DWDS-ACC-BB MG 84mm	₹ 237	Back brackets-84mm (1PAIR)
OE-DWDS-MG 84x500MM	₹ 3,740	System for 500mm(20")
OE-DWDS-W/O-BB-MG 500mm	₹ 3,575	Metal walls & L/R sliding channel-500mm (SET)
OE-DWDS-ACC-BB MG 84mm	₹ 237	Back brackets-84mm (1PAIR)
OE-DWDS-MG 84x550MM	₹ 4,125	System for 550mm(22")
OE-DWDS-W/O-BB-MG 550mm	₹ 3,905	Metal walls & L/R sliding channel-550mm (SET)
OE-DWDS-ACC-BB MG 84mm	₹ 237	Back brackets-84mm (1PAIR)

ERGOTEC™ DRAWER SYSTEM WITH SINGLE RAILS



Scan QR for Installation Video



SOFT CLOSE

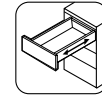

FULL EXTENSION



WT. CARRYING CAPACITY



DUAL-SYNCHRO

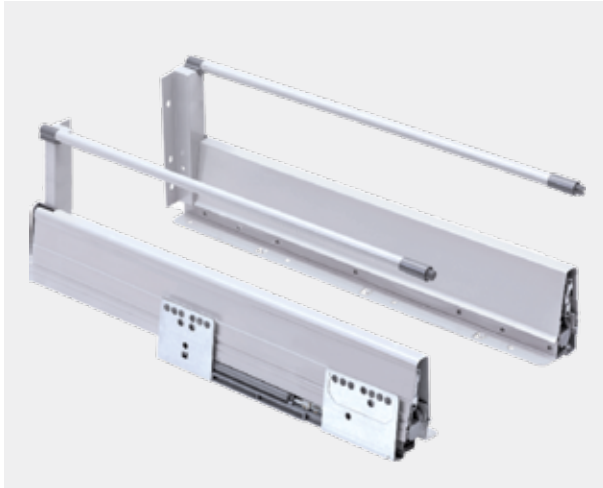

Item Code & MRP Table

How to Order		
Item Code	MRP	Item Description & qty
OE-DWDS-SR MG 135x350MM	₹ 3,630	System for 350mm(14")
OE-DWDS-W/O-BB-MG 350mm	₹ 2,948	Metal walls & L/R sliding channel-350mm (SET)
OE-DWDS-ACC-BB MG 135mm	₹ 314	Back brackets-135mm (1 PAIR)
OE-DWDS-RL MG 350mm	₹ 435	Single rail gallery 350mm (SET)
OE-DWDS-SR MG 135x400MM	₹ 3,850	System for 400mm(16")
OE-DWDS-W/O-BB-MG 400mm	₹ 3,025	Metal walls & L/R sliding channel-400mm (SET)
OE-DWDS-ACC-BB MG 135mm	₹ 314	Back brackets-135mm (1 PAIR)
OE-DWDS-RL MG 400mm	₹ 440	Single rail gallery 400mm (SET)
OE-DWDS-SR MG 135x450MM	₹ 3,960	System for 450mm(18")
OE-DWDS-W/O-BB-MG 450mm	₹ 3,190	Metal walls & L/R sliding channel-450mm (SET)
OE-DWDS-ACC-BB MG 135mm	₹ 314	Back brackets-135mm (1 PAIR)
OE-DWDS-RL MG 450mm	₹ 473	Single rail gallery 450mm (SET)
OE-DWDS-SR MG 135x500MM	₹ 4,389	System for 500mm(20")
OE-DWDS-W/O-BB-MG 500mm	₹ 3,575	Metal walls & L/R sliding channel-500mm (SET)
OE-DWDS-ACC-BB MG 135mm	₹ 314	Back brackets-135mm (1 PAIR)
OE-DWDS-RL MG 500mm	₹ 589	Single rail gallery 500mm (SET)
OE-DWDS-SR MG 135x550MM	₹ 4,840	System for 550mm(22")
OE-DWDS-W/O-BB-MG 550mm	₹ 3,905	Metal walls & L/R sliding channel-550mm (SET)
OE-DWDS-ACC-BB MG 135mm	₹ 314	Back brackets-135mm (1 PAIR)
OE-DWDS-RL MG 550mm	₹ 589	Single rail gallery 550mm (SET)

ERGOTEC™ DRAWER SYSTEM WITH DOUBLE RAILS



SOFT CLOSE

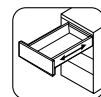

FULL EXTENSION



35 Kg
WT. CARRYING
CAPACITY



DUAL-SYNCHRO



How to Order		
Item Code	MRP	Item Description & qty
OE-DWDS-DR MG199x500MM	₹ 5,005	System for 500mm(20")
OE-DWDS-W/O-BB-MG 500mm	₹ 3,575	Metal walls & L/R sliding channel-500mm (SET)
OE-DWDS-ACC-BB MG 199mm	₹ 358	Back brackets-199mm (1 PAIR)
OE-DWDS-RL MG 500mm	₹ 589	Single rail gallery 500mm (SET)
OE-DWDS-RL-D MG 500mm	₹ 545	Double rail gallery 500mm (SET)
OE-DWDS-DR MG 199x550MM	₹ 5,445	System for 550mm(22")
OE-DWDS-W/O-BB-MG 550mm	₹ 3,905	Metal walls & L/R sliding channel-550mm (SET)
OE-DWDS-ACC-BB MG 199mm	₹ 358	Back brackets-199mm (1 PAIR)
OE-DWDS-RL MG 550mm	₹ 589	Single rail gallery 550mm (SET)
OE-DWDS-RL-D MG 550mm	₹ 589	Double rail gallery 550mm (SET)

ERGOTEC™ DRAWER SYSTEM WITH METAL SIDE SUPPORT WALLS



SOFT CLOSE

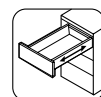

FULL EXTENSION



35 Kg
WT. CARRYING
CAPACITY

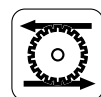

DUAL-SYNCHRO



How to Order		
Item Code	MRP	Item Description & qty
OE-DWDS-SMW MG 199x500MM	₹ 5,390	System for 500mm(20")
OE-DWDS-W/O-BB-MG 500mm	₹ 3,575	Metal walls & L/R sliding channel-500mm (SET)
OE-DWDS-ACC-BB MG 199mm	₹ 358	Back brackets-199mm (1PAIR)
OE-DWDS-RL MG 500mm	₹ 589	Single rail gallery 500mm (SET)
OE-DWDS-SSE-R MG 500mm	₹ 979	Single steel wall hanging panels 500mm (SET)
OE-DWDS-SMW MG 199x550MM	₹ 6,050	System for 550mm(22")
OE-DWDS-W/O-BB-MG 550mm	₹ 3,905	Metal walls & L/R sliding channel-500mm (SET)
OE-DWDS-ACC-BB MG 199mm	₹ 358	Back brackets-199mm (1PAIR)
OE-DWDS-RL MG 550mm	₹ 589	Single rail gallery 500mm (SET)
OE-DWDS-SSE-R MG 550mm	₹ 1,188	Single steel wall hanging panels 500mm (SET)

ERGOTEC™ SLEEK DRAWER SYSTEM

Maximizing Internal Storage Space



SOFT CLOSE



FULL EXTENSION



40 Kg
WT. CARRYING
CAPACITY



DUAL-SYNCHRO



OE-DWDS-SL Grey- Product Kit



OE-DWDS-SL White- Product Kit

Sizes Available in Grey Color:

Item Code	MRP
OE-DWDS-SL Grey 89*450mm	₹ 2,860
OE-DWDS-SL Grey 89*500mm	₹ 3,850
OE-DWDS-SL Grey 89*550mm	₹ 4,620
OE-DWDS-SL Grey 121*450mm	₹ 3,465
OE-DWDS-SL Grey 121*500mm	₹ 4,565
OE-DWDS-SL Grey 121*550mm	₹ 5,335
OE-DWDS-SL Grey 185*450mm	₹ 4,070
OE-DWDS-SL Grey 185*500mm	₹ 5,170
OE-DWDS-SL Grey 185*550mm	₹ 6,105

Sizes Available in White Color:

Item Code	MRP
OE-DWDS-SL White 89*450mm	₹ 2,860
OE-DWDS-SL White 89*500mm	₹ 3,850
OE-DWDS-SL White 89*550mm	₹ 4,620
OE-DWDS-SL White 121*450mm	₹ 3,465
OE-DWDS-SL White 121*500mm	₹ 4,565
OE-DWDS-SL White 121*550mm	₹ 5,335
OE-DWDS-SL White 185*450mm	₹ 4,070
OE-DWDS-SL White 185*500mm	₹ 5,170
OE-DWDS-SL White 185*550mm	₹ 6,105



Key Features:

- Full-extension sliding system for a smooth and consistent closure
- Suitable for all 90mm height drawer
- Allows the maximum access to drawer
- DUAL-Synchro and slow motion (FR) damping technology provide easy movement
- Load capacity of **40Kg**

Specifications:

- Fully Synchronized motion,
- Smooth opening and closing
- No side accessories required for different heights
- Handy 3D three dimensional front adjustment
- No groove required under the drawer to fix the clip

Kit Includes:

- Drawer channels/slides: 1 Pair
- Side wall panels: 1 Pair
- Locking devices: 1 Pair
- Cover clip with Ozone logo printed: 1 Pair



Scan QR for Installation Video

KITCHEN TALL UNIT



- Silent Mechanism
- Adjustable frame height
- Available in 2 different width
- Available in 2 different adjustable height
 - 1150-1410mm
 - 1900-2160mm



Scan QR for Installation Video

Available Sizes:

Size	MRP	Detail
450mm(W) (4+4) Basket & Frame	₹ 7,975	OK-TU.B.8B-450mm SS
	₹ 18,590	OK-TU.F.8B-450mm SS
600mm(W) (4+4) Basket & Frame	₹ 11,110	OK-TU.B.8B-600mm SS
	₹ 25,960	OK-TU.F.8B-600mm SS
450mm(W) (6+6) Basket & Frame	₹ 10,274	OK-TU.B.12 B-450mm SS
	₹ 23,760	OK-TU.F.12 B-450mm SS
600mm(W) (6+6) Basket & Frame	₹ 12,540	OK-TU.B.12 B-600mm SS
	₹ 29,810	OK-TU.F.12 B-600mm SS

BOTTLE PULL-OUT

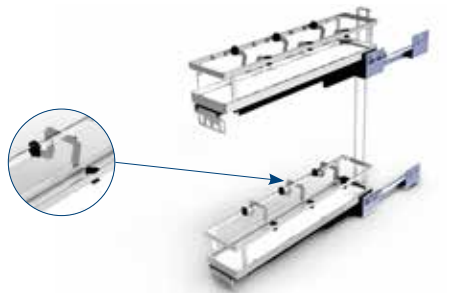

Code	MRP	Sizes
OK-BPO-L/R 150mm CP	₹ 7,161	150mm



Code	MRP	Sizes
OK-BPO-200mm CP	₹ 7,799	200mm

SS DISH RACK WITH DRAIN TRAY

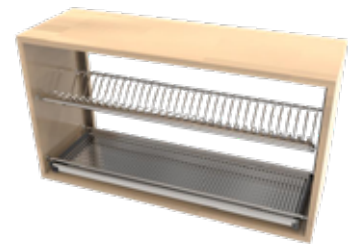

Code	MRP	Sizes
OK-DR-N 600mm SSS	₹ 2,217	600mm
OK-DR-N 800mm SSS	₹ 2,574	800mm
OK-DR-N 900mm SSS	₹ 2,948	900mm

CORNER ORGANIZERS

S Carousel



Code	MRP	Sizes
OK-SC-L/R 900mm CP	₹ 23,540	900mm



Scan QR for Installation Video

Magic Corner



Code	MRP	Sizes
OK-MCB-900mm SSS	₹ 7,975	900mm
OK-MCF-L/R-900mm SSS	₹ 18,260	Basket & Frame



Scan QR for Installation Video

PANTRY UNITS WITH SQUARE RAIL

- Ergotec Pantry Unit's inner drawers can be installed at any height as per your choice
- Simply take one of our Ergotec standard 84 mm drawer set and with addition of Pantry Drawer Front Set turn your cabinet into Pantry/Larder Unit



How to Order

Item Code	MRP	Detail	Standard Height (84mm, Length 500mm)	Medium Height (135mm, Length 500mm)	Tall Height (199mm, Length 500mm)
OE-PU-FP 1100MM MG	₹ 1,502	Front panel 1100mm	01 PC (as per length requirement)	01 PC (as per length requirement)	01 PC (as per length requirement)
OE-PU-FB 84mm MG	₹ 219	Front bracket 84mm	01 set	-	-
OE-DWDS-ACC-BB MG 84mm	₹ 237	Back bracket 84mm	01 set	-	-
OE-DWDS-W/O-BB-MG 500mm	₹ 3,575	Metal walls & L/R sliding channel-500mm	01 set	01 set	01 set
OE-PU-FB 135mm MG	₹ 270	Front bracket 135mm	-	01 set	-
OE-DWDS-ACC-BB MG 135mm	₹ 314	Back bracket 135mm	-	01 set	-
OE-PU-RLSQ 500mm MG	₹ 688	Single SQUARE rail gallery 500mm	-	01 set	01 set
OE-PU-FHSQ-1100mm MG	₹ 787	Square front handle 1100mm	-	01 PC (as per length requirement)	01 PC (as per length requirement)
OE-PU-FB 199mm MG	₹ 319	Front bracket 199mm	-	-	01 set
OE-DWDS-ACC-BB MG 199mm	₹ 358	Back bracket-199mm	-	-	01 set
OE-PU-RLSQ-D 500mm MG	₹ 649	Double SQUARE rail gallery 500mm	-	-	01 set



Standard Height Drawer



Medium Height Drawer



Large Height Drawer

PANTRY UNITS WITH ROUND RAIL

- Ergotec Pantry Unit's inner drawers can be installed at any height as per your choice
- Simply take one of our Ergotec standard 84 mm drawer set and with addition of Pantry Drawer Front Set turn your cabinet into Pantry/Larder Unit



How to Order





Item Code	Mrp	Detail	Standard Height (84mm, Length 500mm)	Medium Height (135mm, Length 500mm)	Tall Height (199mm, Length 500mm)
OE-PU-FP 1100MM MG	₹ 1,502	Front panel 1100mm	01 PC (as per length requirement)	01 PC (as per length requirement)	01 PC (as per length requirement)
OE-PU-FB 84mm MG	₹ 219	Front bracket 84mm	01 set	-	-
OE-DWDS-ACC-BB MG 84mm	₹ 237	Back bracket 84mm	01 set	-	-
OE-DWDS-W/O-BB-MG 500mm	₹ 3,575	Metal walls & L/R sliding channel-500mm	01 set	01 set	01 set
OE-PU-FB 135mm MG	₹ 270	Front bracket 135mm	-	01 set	-
OE-DWDS-ACC-BB MG 135mm	₹ 314	Back bracket 135mm	-	01 set	-
OE-DWDS-RL MG-500mm	₹ 589	Single ROUND rail gallery 500mm	-	01 set	01 set
OE-PU-FHSQ-1100mm MG	₹ 787	Square front handle 1100mm	-	01 PC (as per length requirement)	01 PC (as per length requirement)
OE-PU-FB 199mm MG	₹ 319	Front bracket 199mm	-	-	01 set
OE-DWDS-ACC-BB MG 199mm	₹ 358	Back bracket-199mm	-	-	01 set
OE-DWDS-RL-D MG 500mm	₹ 545	Double ROUND rail gallery 500mm	-	-	01 set



DRAWER ORGANIZERS

INTER DIVIDING GALLERY RAIL KITS





Item Code	Description	Product
OE-DWDS-PA-RL MG 1100MM ₹ 292	Horizontal/Transversal Rail	
OE-DWDS-PA-TC MG Std. ₹ 61	T-Connector	
OE-DWDS-PA-CC MG Std. ₹ 59	Connecting clip	
OE-DWDS-PA-EC MG Std. ₹ 79	End cap	

- Cross Railing available in 1100mm size with T or L connectors
- Quantity can be ordered as per the requirement

HORIZONTAL & VERTICAL DIVIDING PANEL



Item Code	Description	Product
OE-DWDS-PA-HDP-G MG 1100MM ₹ 1,502	Works in conjunction with glass clip set	
OE-DWDS-PA-HDP-M MG 1100MM ₹ 1,502	Fixed with metal hanging panel (OE-DWDS-SSE-R)	
OE-DWDS-PA-VDP MG STD ₹ 237	Vertical divide panel	

- Both horizontal and vertical dividing panels are fitted with appropriate end fittings
- Must be used in conjunction with double wall high metal drawer sides

DRAWER MAT



OK-ASM 0.5x4M GR	₹ 3,927
OK-ASM 0.5x2M GR	₹ 2,074

Width: 500mm
Available in 2 mtr & 4 mtr

CLASSIC FIT - PVC CUTLERY ORGANIZERS



OK-CT-900MM MG ₹ 2,005

(Available without divider)
Size (mm) : 830 x 485 x 50 (WxDxH)



OK-CT-600MM MG ₹ 1,385

(Available with divider)
Size (mm) : 530 x 485 x 50 (WxDxH)



OK-CT-450MM MG ₹ 955

(Available with divider)
Size (mm) : 380 x 485 x 50 (WxDxH)

ADJUSTABLE DISH ORGANIZERS



OK-APH-SS GR ₹ 2,981

Adjustable Dish Holder

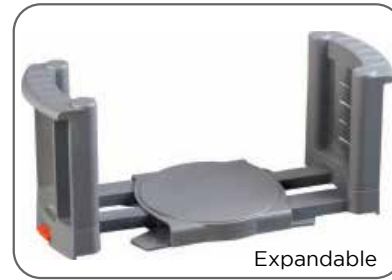

Expandable

KITCHEN TRASH BINS

2 COMPARTMENT BIN



OK-POB-2 STD GREY ₹ 11,440

Pull Out Trash Bin
Size (mm): 303 x 360 x 224 (WxDxH)
10L x 2 with door mount bracket
Max Weight Carrying Capacity: **25kg**

3 COMPARTMENT BIN



OK-POB-3 STD GREY ₹ 11,440

Pull Out Trash Bin
20L + 10L x 2 with door mount bracket
20L Size (mm): 303 x 360 x 224 (WxDxH)
10L Size (mm): 224 x 360 x 151 (WxDxH)
Max Weight Carrying Capacity: **25kg**



OK-RB 14 LTR SS ₹ 2,981

Swing Out Trash Bin
Size (mm): 365 x 280 x 355 (WxDxH)
Max Weight Carrying Capacity: **14ltr**

ROLLER SHUTTER SYSTEMS

Three Step Aluminium Roller Shutter With Manual Operation

(Aluminium & SS Finish)

OE-RS-M 600x1500 AN	₹ 23,540
OE-RS-M 600x1500 SS	₹ 24,750
OE-RS-M 900x1500 AN	₹ 30,250
OE-RS-M 900x1500 SS	₹ 34,320



Glass Roller Shutter With Manual Operation

OE-RS-G 600x1400 WHITE	₹ 56,650
OE-RS-G 600x1400 FROSTED	₹ 56,650



ALUMINIUM SKIRTING



Square/Flexi Corner Connector



OK-SK-100 3mtrs SSS	₹ 1,271
OK-SK-150 3mtrs SSS	₹ 1,848

PVC Skirting with Aluminium Foil
Length: 3mtr
Finish: SSS



Flexible Connector

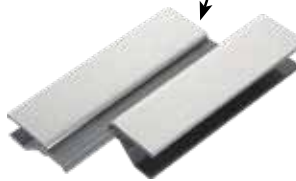

OK-SK-ACC 100mm SSS	₹ 118
OK-SK-ACC 150mm SSS	₹ 132

Flexible Connectors with bottom plastic seal
Height: 100mm & 150mm
Finish: SSS

CABINET LEGS WITH CLIPS



OK-ALC 150mm BL	₹ 314
-----------------	-------

Adjustable Leg with Clip
Set= 4Legs+2Clips

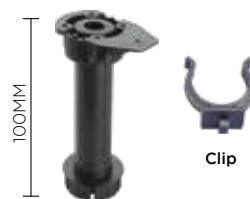

OK-ALC 100mm BL	₹ 196
-----------------	-------

Adjustable Leg with Clip
Set= 4Legs+2Clips



OK-ALC-ACC-RC	₹ 6,523
---------------	---------

Adjustable Legs Clip
500Pcs in one Pkt.

HEAVY DUTY BI-FOLD LIFT UP SYSTEM - SOFT CLOSE



OK.LU.BF.HD Std Grey ₹ 8,580

Ideal for higher wall cabinets

Carcas Details:

Width	Height	Max. Weight (Per Shutter)
900-1200mm	700-800mm	4.7Kg

Set comprises:

- Lift-up Mechanism with Cover: 01 pair
- Auto Close Hinges: 01 pair
- Center Hinges with Accessories

Power Adjustable



BI-FOLD LIFT UP SYSTEM - SOFT CLOSE

OK.LU.BF.N Std Grey ₹ 8,580

Ideal for higher wall cabinets

Carcas Details:

Width	Height	Max. Weight (Per Shutter)
700-900mm	700-750mm	3.5Kg



Scan QR for Installation Video



90° OPENING LIFT-UP SYSTEM - 3D ADJUSTABLE SOFT CLOSE

Available against bulk orders only

OK.LU.90N STD GR ₹ 6,006

Carcas Details:

Width	Height	Max. Weight
600-1200mm	500-600mm	6Kg



OK.LU.90N STD WHITE ₹ 6,061

Carcas Details:

Width	Height	Max. Weight
600-1200mm	500-600mm	6Kg



90° OPENING HEAVY-DUTY LIFT-UP SYSTEM - 3D ADJUSTABLE SOFT CLOSE

Available in White Colour also against bulk order

OK.LU.90HD STD GR ₹ 7,277

Carcas Details:

Width	Height	Max. Weight
900-1800mm	600-700mm	13.25Kg



Scan QR for Installation Video

PNEUMATIC PUMPS



Product Code	MRP
OK.PP.01Spro 60N GR	₹ 506
OK.PP.01Spro 80N GR	₹ 506
OK.PP.01Spro 100N GR	₹ 506
OK.PP.01Spro 120N GR	₹ 506

PNEUMATIC PUMPS SOFTPRO
(With Cover on Arms)



Product Code	MRP
OK.PP.01N 60N GR	₹ 429
OK.PP.01N 80N GR	₹ 429
OK.PP.01N 100N GR	₹ 429
OK.PP.01N 120N GR	₹ 429

PNEUMATIC PUMPS

SMART BED LIFT-UP SYSTEM



Soft Close

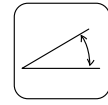

33° Opening Angle



Easy to Lift

Features:

- Available in 04 load capacity
- Effortless Opening
- 33 degree (wide) opening angle for easy access
- Easy to lift with the weight of top board
- Top Stay Feature
- Long brackets for better support to bed platform
- Easy to Install
- Ideal for storage under bed

Frames



Size	Item Code	MRP
900mm	OE.BLU.F 900mm Std Black	₹ 1,399
1520mm	OE.BLU.F 1500mm Std Black	₹ 2,111

Pumps



Wt. Capacity	Item Code	MRP
50kg	OE.BLU.P 500N Black	₹ 1,301
75kg	OE.BLU.P 750N Black	₹ 1,301
120kg	OE.BLU.P 1200N Black	₹ 1,301
150kg	OE.BLU.P 1500N Black	₹ 1,301

VERTICAL FOLDABLE WALL MOUNT BED - WITH AUTOMATIC MECHANISM



**FOLD UP TO
MAKE A SOFA**

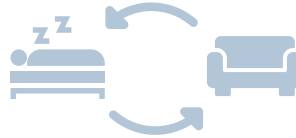

OZ-WBV-A-SF-1220 Std ₹ 99,500

Features:

- Concealed wall bed design
- Vertical foldable wall mount system
- Motorized mechanism with remote option
- Easy to open/close
- Adds style, comfort & flexibility

Dimension:

1200mm*2000mm (W*L)

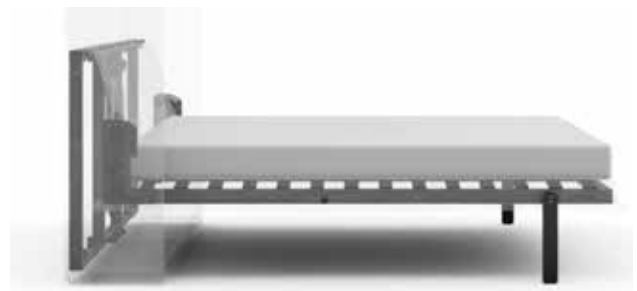

**Mattress is not included*



**FOLD UP THE BED
TO MAKE A
WORKING TABLE**



OZ-WBV-A-TB-1220 Std ₹ 99,500

Features:

- Concealed wall bed design
- Vertical foldable wall mount system
- Motorized mechanism with remote option
- Table available in vertical and horizontal options
- Adds style, comfort & flexibility

Dimension:

1200mm*2000mm (W*L)

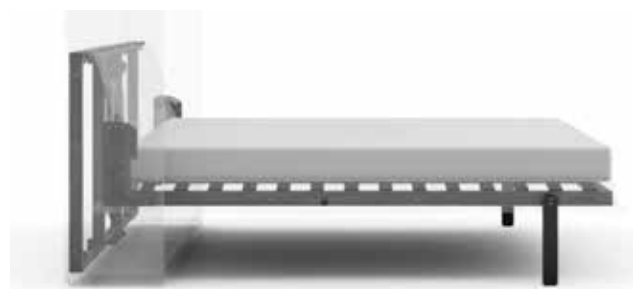

**Mattress is not included*

ALUMINIUM FRAME PROFILES FOR GLASS PANELS/SHUTTERS

OEAP-45F 3M AN	₹ 1,617
OEAP-45F 3M SS	₹ 2,013

Aluminium Frame Profile

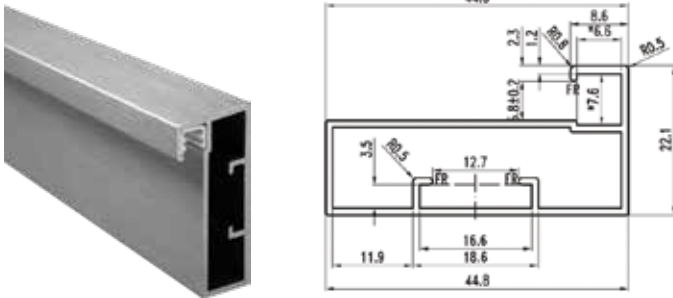

Calculation of inlay in sections size
 • Thickness: 4 or 5mm (Glass/Panel)

OEAP-45H 3M AN	₹ 2,354
OE AP-45H 3M SS	₹ 2,827

Aluminium Handle Frame Profile

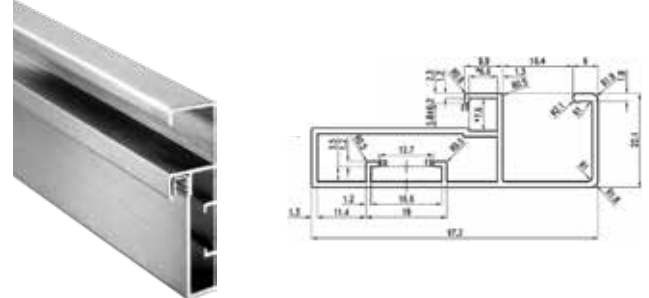

Calculation of inlay in sections size
 • Thickness: 4 or 5mm (Glass/Panel)

OEAP-50F 3M AN	₹ 2,013
OEAP-50F 3M SS	₹ 2,475

Aluminium Frame Profile

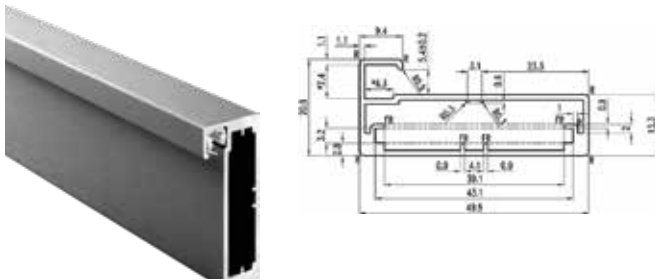

Calculation of inlay in sections size
 • Thickness: 4 or 5mm (Glass/Panel)

OEAP-50H 3M AN	₹ 2,530
OEAP-50H 3M SS	₹ 2,937

Aluminium Handle Frame Profile

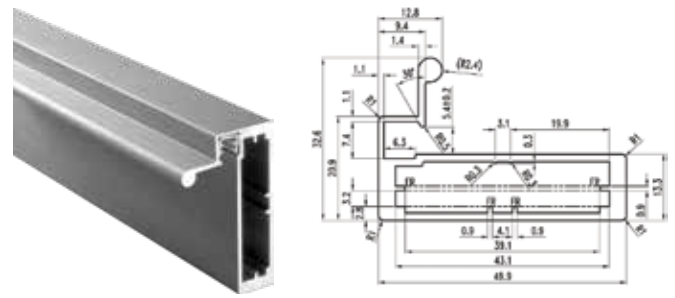

Calculation of inlay in sections size
 • Thickness: 4 or 5mm (Glass/Panel)

ALUMINIUM HANDLE PROFILES FOR WOODEN PANELS

OEAP-G 3M AN	₹ 1,518
OEAP-G 3M SS	₹ 1,892

Aluminium Handle Frame Profile

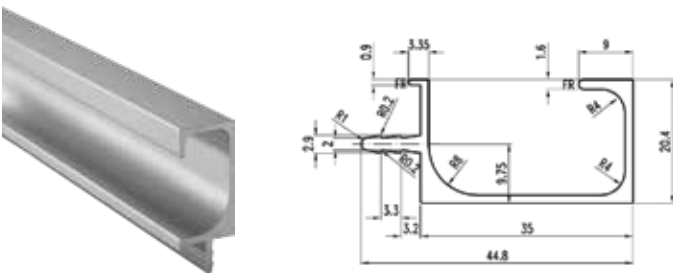

OEAP-J 3M AN	₹ 2,046
OEAP-J 3M SS	₹ 2,354

Aluminium Handle Frame Profile

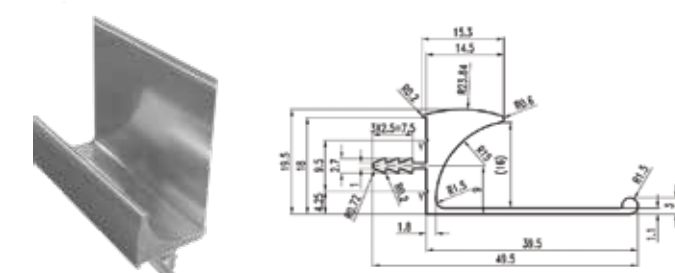

CORNER CONNECTORS FOR ALUMINIUM PROFILES

OEAP-ACC1 Std	₹ 237
---------------	-------

Connector for Aluminium Frame & Handle Profile for Glass Doors

Specification
 Corner Connector for

OEAP-45F-AN	MRP on Request
OEAP-45F-SS	₹ 1,830
OEAP-45H-AN	MRP on Request
OEAP-45H-SS	₹ 2,570



Available 4 pcs in one set with necessary screws

OEAP-ACC2 Std	₹ 237
---------------	-------

Connector for Aluminium Frame & Handle Profile for Glass Doors

Specification
 Corner Connector for

OEAP-50F-AN	MRP on Request
OEAP-50F-SS	₹ 2,250
OEAP-50H-AN	MRP on Request
OEAP-50H-SS	₹ 2,670



Available 4 pcs in one set

MINI FIXES



₹ 1,095

OZ-MF-03-E 10MM White
Nylon Socket
Unit: Pkt. 500 Pcs.



₹ 2,442

OZ-MF-01-L 15/18mm Std.
Board Thickness 15 mm with
Cover Flange
Unit: Pkt. 500 Pcs.



₹ 277

OZ-MF-ACC-01N Std
Brown
Plastic Cap for 15mm Cam
Unit: Pkt. 500 Pcs.



₹ 1,265

OZ-MF-02 34MM Std.
Thread Bolt with
Black Plastic
Unit: Pkt. 500 Pcs.



₹ 2,420

OZ-M6-ST1-H 10MM STD
OZ-M6-ST1-H 13MM STD
Mini-Fix
Unit: Pkt. 450 Pcs.



₹ 219

OZ-PMC-Std Std
Push Catcher



₹ 98

OZ-MC-Std Std
Magnetic Door Catcher

SHELF - SUPPORT



OE-SHL-G ₹ 3,476

Shelf Support for Glass
Unit: Pkt. 500 Pcs.



OE-SHL-W ₹ 2,448

Shelf Support for Wooden Shelves
Unit: Pkt. 500 Pcs.

BUTTERFLY & WOODEN DOWEL PINS



OE-CF-B ₹ 2,585

Butterfly type Connection Fitting
Unit: Pkt. 100 Pcs.



OZ-WD-SL 6x35 Std. ₹ 3,740

Wooden Dowel Pin
Unit: Pkt. 4000 Pcs.



OZ-WD-SL 8x40 Std. Pkt. ₹ 3,927

Wooden Dowel Pin
Unit: Pkt. 4000 Pcs.

MULTIDRAWER LOCKS



OE-MDL 500MM CP	₹ 248
OE-MDL-4P 580mm CP	₹ 231

Front Mounted Multi Drawer Lock with Aluminium Bar Length 500/580mm for 3/4 Drawers
No. of keys : 2 Keys



OE-MDL-3P-SM 500mm CP	₹ 193
OE-MDL- 4P-SM 580mm CP	₹ 231

Side Mounted Multi Drawer Lock with Aluminium Bar Length 500/580mm for 3/4 Drawers

WARDROBE SLIDING DOOR LOCKS



- Features:**
- Suitable for 25mm shutters
 - Twist and turn system
 - Single locking for 2 overlapped sliding shutters
 - Universal lock for sliding shutters with either side opening
 - High security two computerized keys
 - System 32 compatible

OE.WSL1-25 STD NP	₹ 429
-------------------	-------

Twist & Turn Lock



- Features:**
- Suitable for 22mm shutters
 - Push and turn system
 - Single locking for 2 overlapped sliding shutters
 - Universal lock for sliding shutters with either side opening

OE.WSL2-22 STD CP	₹ 231
-------------------	-------

Push & Turn Lock

CUPBOARD LOCKS WITH COMPUTERIZED KEYS



OE-CL-11 32MM SSS	₹ 583
OE-CL-11 20/25MM SSS	₹ 556

Cupboard Lock



OE-CL-22 21MM SSS	₹ 396
-------------------	-------

Cupboard Lock (Small)



OE-CL-3P 22mm CP	₹ 902
------------------	-------

Cupboard Lock

- Features:**
- Suitable for 22mm Thick panel
 - Die cast body
 - Two point swing arm lock at top and bottom, also locking with the third point at central eliminates use of towbolt
 - System 32 compatible
 - Reversible keys with click action mechanism
 - High security computerized keys

Application:
• Cupboards & Cabinets

CUPBOARD LOCKS



Features:

- Suitable for 22mm Thick panel
- Die cast body
- Click action mechanism
- Round multipurpose lock with crank bolt specially designed for overlapped shutters fitted with auto close hinge and drawers with overlay facia
- Reversible keys with click action mechanism

OE-CL-C 22mm CP ₹ 160

Cupboard Lock

Application:

- Cupboards & Cabinets

PEDESTAL LOCKS



OE-PDL-STD-CP ₹ 165

For front mount multi drawer pedestal units

FURNITURE LOCKS



Features:

- Suitable for 22mm Thick panel
- Die cast body
- Reversible keys with click action mechanism

Application:

- Cupboards & Cabinets

OE-MPL-R 22mm CP ₹ 154

Multipurpose Lock



Computerized key

Features:

- Suitable for 22mm Thick panel
- Die cast body
- No key require for locking system
- Reversible keys with click action mechanism
- High security computerized keys

Application:

- Cupboards & Cabinets

OE-MPL-12 22mm CP ₹ 253

Multipurpose Lock with Computerized Key

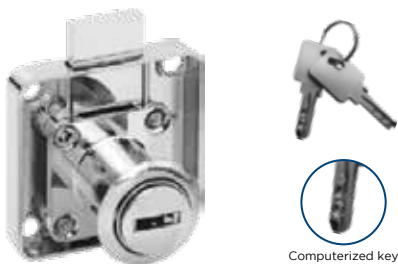

Computerized key

OE-MPL-11-22MM-NP ₹ 277

Multipurpose Lock with Computerized Key



OE-MPL 22MM CP ₹ 123

Multipurpose Lock

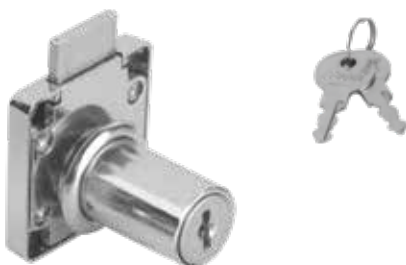

OE-MPL 32MM CP ₹ 145

Multipurpose Lock



OE-CL-33 Std SSS ₹ 374

Universal Lock

PASSWORD & FINGERPRINT LOCK

OZFL-201-PW ₹ 2,990

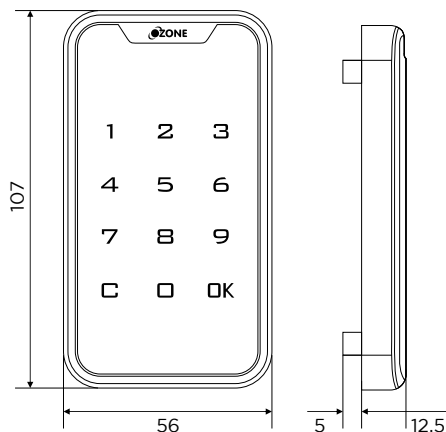

Access Modes



Master PIN Code



User PIN Code

Alarms



Low Battery Indicator



Auto Secure

Smart Features



USB for Battery Backup



Anti-theft Password



Public Mode

Door Thickness



5-24mm

Finish



Black

RFID CARD LOCK

OZFL-202-RF ₹ 2,790

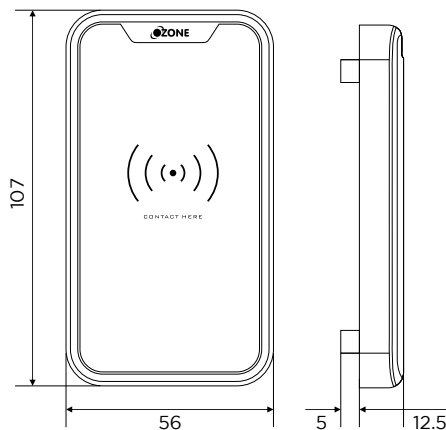

Access Modes



RFID Card

Alarm



Low Battery Indicator

Smart Features



USB for Battery Backup

Door Thickness



5-24mm

Finish



Black

Note: All dimensions are in mm

PASSWORD LOCKS

OZFL-203-PF ₹ 5,690

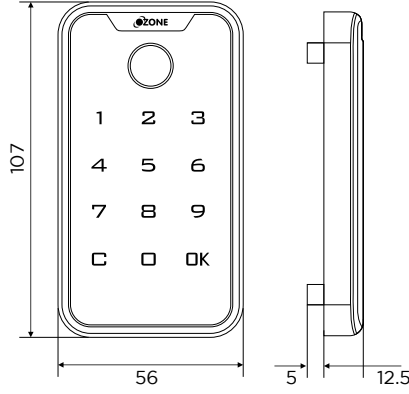

Access Modes



Fingerprint



Master PIN Code



User PIN Code

Alarms



Low Battery Indicator



Auto Secure

Smart Features



USB for Battery Backup



Anti-theft Password



Public Mode

Door Thickness



5-24mm

Finish



Black



Note: All dimensions are in mm

PASSWORD LOCK

OZFL-401-PW ₹ 2,990

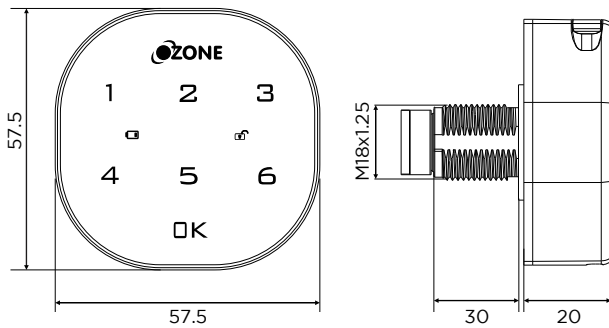

Access Modes



Master PIN Code



User PIN Code

Alarms



Low Battery Indicator



Auto Secure

Smart Features



USB for Battery Backup



Anti-theft Password



Public Mode

Door Thickness



1-18mm

Finish



Black

Options available for Multi Drawers and Sliding Cabinets only on request

FINGERPRINT LOCK

OZFL-402-F ₹ 4,690

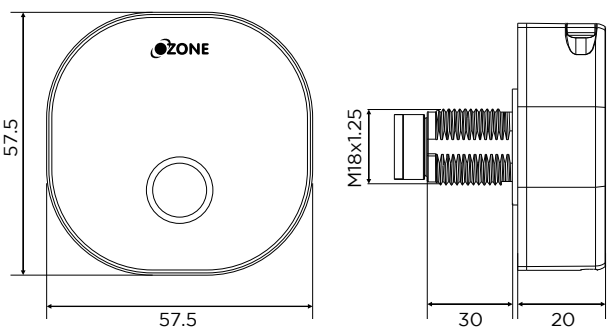

Access Modes



Fingerprint

Alarm



Low Battery Indicator

Smart Features



USB for Battery Backup

Door Thickness



1-18mm

Finish



Black

Options available for Multi Drawers and Sliding Cabinets only on request

Note: All dimensions are in mm

PASSWORD LOCK

OZFL-601-PW ₹ 2,990

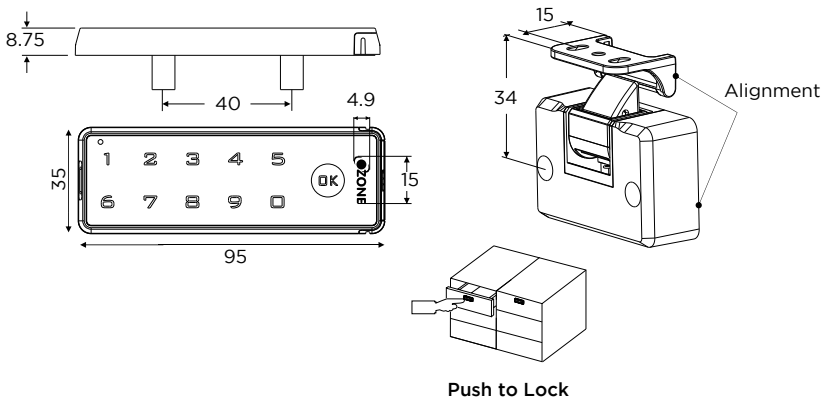

Access Modes



User PIN Code



User PIN Code

Alarms



Low Battery Indicator



Auto Secure

Smart Features



USB for Battery Backup



USB E-Key

Door Thickness



1-25mm

Finish



Black/Silver

PASSWORD LOCK

OZFL-101-PK ₹ 3,990

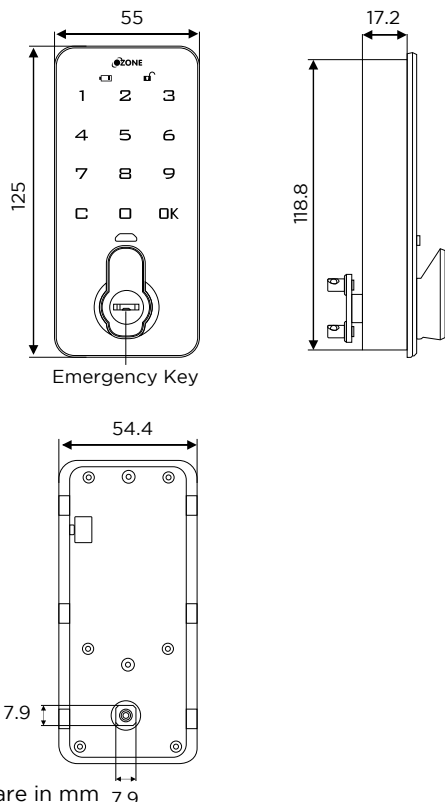

Access Modes



Master PIN Code



User PIN Code



Emergency Key

Alarms



Low Battery Indicator



Auto Secure

Smart Features



USB for Battery Backup



Anti-theft Password



Public Mode

Door Thickness



1-15mm

Finish



Black

Note: All dimensions are in mm

FINGERPRINT LOCKS

OZFL-55F Black ₹ 4,990



OZFL-55F White



OZFL-55F SN

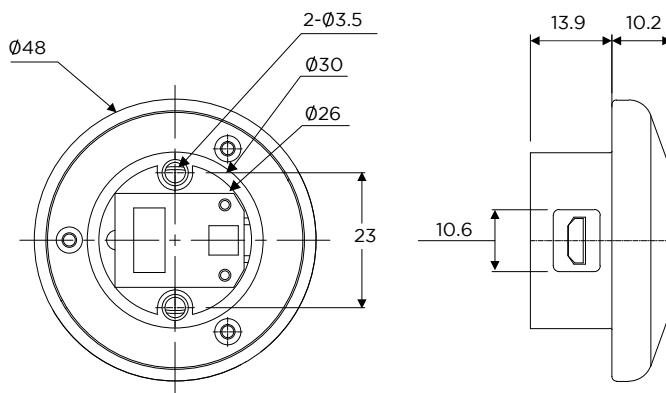

Access Modes



Fingerprint

Alarm



Low Battery Indicator

Smart Features



USB for Battery Backup



Automatic Locking



Manual Locking

Door Thickness



12-20mm

Finish



Black



White



Satin Nickel

PASSWORD LOCK

OZFL-88 P BLACK ₹ 2,390

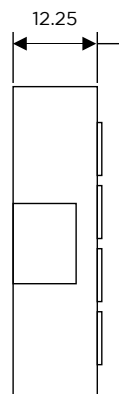
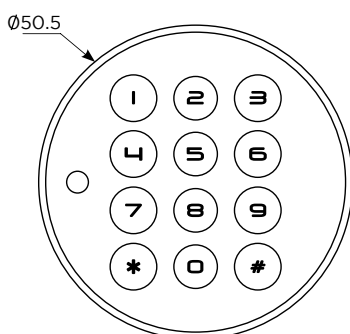

Access Modes



User PIN Code

Alarms



Low Battery Indicator

Smart Features



USB for Battery Backup



Automatic Locking



Manual Locking

Door Thickness



12-20mm

Finish



Black

Note: All dimensions are in mm

PASSWORD & FINGERPRINT LOCKS

OZFL-66V-PF (Vertical) ₹ 4,850

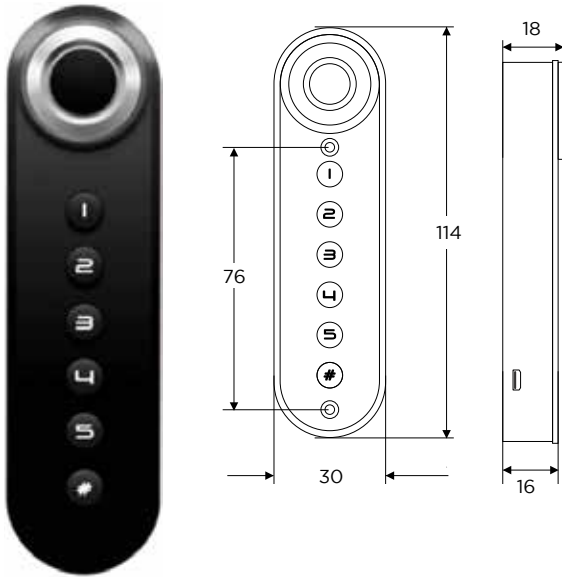

Access Modes



User
PIN Code



Fingerprint

Alarms



Low Battery
Indicator

Smart Features



USB for
Battery Backup



Automatic
Locking



Manual
Locking

Door Thickness



12-20mm

Finish



Black

OZFL-66H-PF (Horizontal) ₹ 4,850

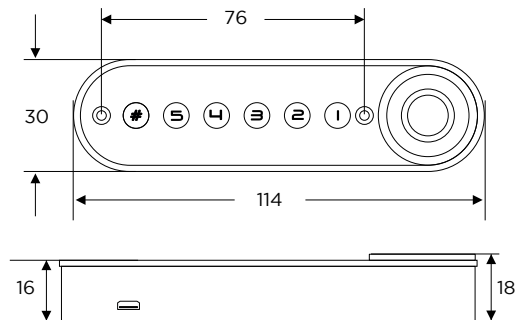

Note: All dimensions are in mm

TOP GLIDE SYSTEM - 1 FOR DOUBLE DOOR WARDROBES



Specifications:

- Utilizes full inner space in the wardrobe
- Tracks not visible
- Door Installation: Inset
- Track mounting: Top
- Application type: Double Door

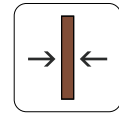

Door Thickness
18-24mm



Weight Carrying
Capacity

INSET SLIDING SYSTEM - 1A (for Wooden Doors)

Product Code	OE.WS.TG1A.TR Std Std Top Roller Set	OE.WS.TG1A./22BR Std Std Bottom Roller Set	OE.WS.TG1A./TT 3mtr AN Top Track 3mtr length	OE.WS.TG1A./22BT 3mtr AN Bottom Track 3mtr length
Product Image				
Set Qty.	1 Set	1 Set	1 Pc. (Length)	1 Pc. (Length)
MRP	₹ 2,640	₹ 1,309	₹ 2,255	₹ 1,254

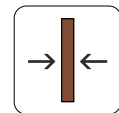

Door Thickness
20-32mm



Weight Carrying
Capacity

INSET SLIDING SYSTEM - 1B (for Wooden Doors)

Product Code	OE.WS.TG1B.TR Std Std Top Roller Set	OE.WS.TG1B.BR Std Std Bottom Roller Set	OE.WS.TG1B.TT 3mtr AN Top Track - 3mtr length	OE.WS.TG1B.BT 3mtr AN Bottom Track 3mtr length
Product Image				
Set Qty.	1 Set	1 Set	1 Pc. (Length)	1 Pc. (Length)
MRP	₹ 3,410	₹ 1,320	₹ 2,585	₹ 1,529

TOP GLIDE SYSTEM 22 FOR DOUBLE DOORS WARDROBE



Specifications:

- Utilizes full inner space in the wardrobe
- Tracks not visible
- Door Installation: Overlay
- Can be used for wardrobe width upto 10 feet
- Track mounting: Top
- Application type: Double Door



Scan QR for Installation Video

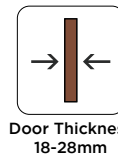

Door Thickness
18-28mm



Weight Carrying
Capacity

TOP GLIDE SYSTEM - 22 W (for Wooden Doors)

Product Code	OE.WS.TG22W.TR Std Std Top Roller Set	OE.WS.TG1A/22.BR Std Std Bottom Roller Set	OE.WS.TG22.TT 3mtr AN Top Track 3mtr length	OE.WS.TG1A/22.BT 3mtr AN Bottom Track 3mtr length	OE.WS.TG22.SC.W Std Gr Soft Close TG22
Product Image					
Set Qty.	1 Set	1 Set	1 Pc. (Length)	1 Pc. (Length)	1 Set
MRP	₹ 2,976	₹ 1,309	₹ 2,024	₹ 1,254	₹ 3,839

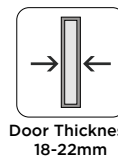

Door Thickness
18-22mm



Weight Carrying
Capacity

TOP GLIDE SYSTEM - 22 F (for Framed Doors)

Product Code	OE.WS.TG22F.TR Std Std Top Roller Set	OE.WS.TG1A/22 BR Std Std Bottom Roller Set	OE.WS.TG22.TT 3mtr AN Top Track 3mtr length	OE.WS.TG1A/22.BT 3mtr AN Bottom Track 3mtr length
Product Image				
Set Qty.	1 Set	1 Set	1 Pc. (Length)	1 Pc. (Length)
MRP	₹ 4,059	₹ 1,309	₹ 2,024	₹ 1,254

TOP GLIDE SYSTEM - 22 FOR TRIPLE DOORS WARDROBES



Specifications:

- Door Type: Wooden/Framed
- Application Type: **3 Doors**
- Door Installation: Overlay
- Track Length: 3mtr

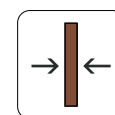

Door Thickness
18-28mm



Weight Carrying
Capacity

TOP GLIDE SYSTEM - 22 W (for Triple Wooden Doors)

Product Code	OE.WS.TG22W.TR.3D STD STD Top Roller Set	OE.WS.TG1A/22.BR.3D STD STD Bottom Roller Set	OE.WS.TG22.TT 3mtr An Top Track 3mtr length	OE.WS.TG1A/22.BT 3MTR An Bottom Track 3mtr length	OE.WS.TG22.SC.W STD Gr Soft Close TG22
Product Image					
Set Qty.	1 Set	1 Set	1 Pc. (Length)	1 Pc. (Length)	1 Set
MRP	₹ 4,466	₹ 1,964	₹ 2,024	₹ 1,254	₹ 3,839

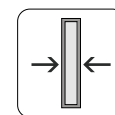

Door Thickness
18-22mm



Weight Carrying
Capacity

TOP GLIDE SYSTEM - 22 F (for Triple Framed Doors)

Product Code	OE.WS.TG22F.TR.3D STD STD Top Roller Set	OE.WS.TG1A/22.BR.3D STD STD Bottom Roller Set	OE.WS.TG22.TT 3mtr An Top Track 3mtr length	OE.WS.TG1A/22.BT 3mtr An Bottom Track 3mtr length
Product Image				
Set Qty.	1 Set	1 Set	1 Pc. (Length)	1 Pc. (Length)
MRP	₹ 6,094	₹ 1,964	₹ 2,024	₹ 1,254

UNI-LINE WARDROBE SLIDING SYSTEM



OE.WS.UNLS 3mtr Std	₹ 81,840
OE.WS.UNLS 2.4mtr Std	₹ 79,310

Features:

- High-end 2 door Wardrobe Sliding System
- Two shutters closes in the same line leaving NO gap
- Soft open and soft close
- Suitable to use on wooden as well as aluminum framed glass doors

Specifications:

- Can be used on doors weighing upto **60kg** each
- Suitable for Wardrobe width **2100mm - 3000mm**



Scan QR for Installation Video



Product kit includes:

ACCESSORIES	QTY.	ACCESSORIES	QTY.
Upper rail component			1
Down rail component			1
Down runner fixing plate	2	Down runner A	1
Down runner B	1	Down runner C	2
Adjustable plate A	2	Adjustable plate B	2
Down rail fixing key	8	Down rail fixing key	8
ST 4x20mm Wooden screw	32	ST 4x16mm Wooden screw	60
2.5mm allen key	1	4mm allen key	1
Drilling jig	1	Wrench	1

*Check product details before placing order.

OZO LINE 65 BOTTOM GLIDE INSET WARDROBE SLIDING SYSTEM



FEATURES:

- Overlapping dual door system
- Suitable to use with single track as well as double track
- Superior spring mechanism for roller's better grip with track
- Smooth functioning and long life
- Soft closing and opening function (optional)

SPECIFICATIONS:

- Door type: Wooden
- Application type: Dual door
- Door Weight: upto **65Kg.**
- Door Thickness: **18-25mm**

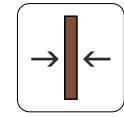

Door Thickness
18-25mm



65 Kg
Weight Carrying
Capacity



Fitting Details:

PRODUCT IMAGE	PRODUCT CODES
	OE.SL65 .TBR Std Std ₹ 1,224 Top Roller- 04 Bottom Roller- 04 Stopper- 04 (2 Door Kits)

Tracks:

	OE.SL65 .TBT 2.4mtr AN ₹ 2,464 Top & Bottom Double Track- 01 set OE.SL65 .TBT 3.6mtr AN ₹ 3,674 Top & Bottom Double Track- 01 set
	OE.SL65 .S.TBT 2.4mtr AN ₹ 1,232 Top & Bottom Single Track- 01 set OE.SL65 .S.TBT 3.6mtr AN ₹ 1,837 Top & Bottom Single Track- 01 set

Optional Fitting:

	OE.SL65 .SCD ₹ 595 Soft Close Dampener- 01 set
--	--

ECONOMY WARDROBE SLIDING SYSTEM



Features:

- Economy wardrobe sliding system
- Common flush track for top & bottom
- Tracks length are available in 2 mtr & 4 mtr

Applications:

- Best suitable for
- Overhead cabinets
 - Office cabinet
 - Small wardrobes

Specifications:

- Weight Carrying Capacity: **40Kg**
- 50,000 life cycle tested



Fitting Set for 1 door consists

- Top Rollers: **1 Set**
- Bottom Rollers: **1 Set**
- Stopper: **1 Set**

OE.WS.BG1-E Std Std ₹ 380 Top & Bottom Roller Set for Single Door	OE.WS.BG1-E.Track 4mtr AN ₹ 787 OE.WS.BG1-E.Track 2mtr AN ₹ 385 Top & Bottom Track

BOTTOM GLIDE SYSTEM



OE.WS.BG1.S Std Std ₹ 666

Top & Bottom Roller Set for Single Door

Features:

- Inset sliding shutters
- Bottom dom track
- Top & bottom rollers provide smooth sliding

Specifications:

- Door type: Wood
- Application type: Dual door
- Door Weight: **upto 60 kg**
- Door Thickness : **18-23mm**
- Track mounting: Bottom
- Track length: 2/3/4 mtr for double & single leaf doors

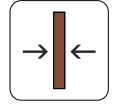

Door Thickness
18-23mm



60 Kg
Weight Carrying
Capacity

System consists fittings for Single Door

- Top Roller: **1 Set**
- Bottom Roller: **1 Set**
- Stopper: **2 Pcs**

SOFT OPENING & CLOSING BOTTOM GLIDE SYSTEM

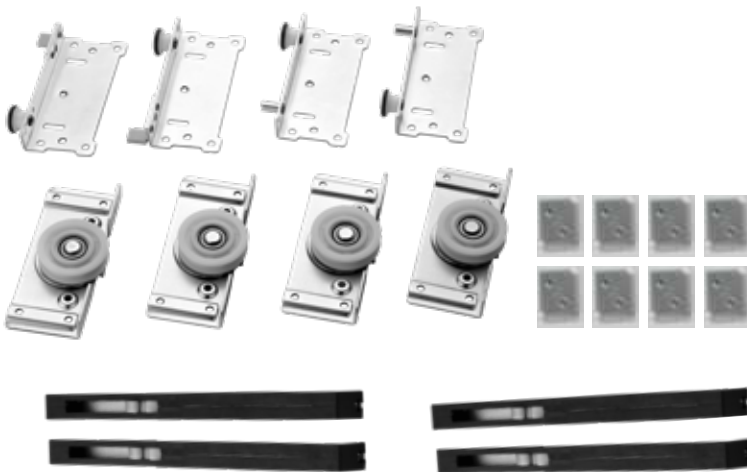

OE.WS.BG1.D.SCO Std Std ₹ 2,915

Top & Bottom Roller Set for Double Door

Features:

- 2 door overlap wardrobe sliding system with both side soft close mechanism
- Ideal for door weight upto **60kg**

Specifications:

- 50,000 life cycle tested
- Suitable for door thickness upto 18-23mm with double track & any thickness with single track

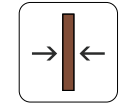

Door Thickness
18-23mm



60 Kg
Weight Carrying
Capacity

Fitting Set for 2 doors consists

- Top Roller: 2 sets
- Bottom Roller: 2 sets
- Soft Close & Soft Open Damper: 4 pcs
- Door Thickness: **18-23mm**



50,000
Cycles Tested

SOFT CLOSE BOTTOM GLIDE SYSTEM



OE.WS.BG1.D.SC Std Std ₹ 2,244

Top & Bottom Roller Set for Double Door

Features:

- 2 door overlap wardrobe sliding system with both side soft close mechanism
- Ideal for door weight upto **60kg**

Specifications:

- 50,000 life cycle tested
- Suitable for door thickness upto 18-23mm with double track & any thickness with single track

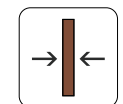

Door Thickness
18-23mm



60 Kg
Weight Carrying
Capacity





Fitting Set for 2 doors consists

- Top Roller: 2 Sets
- Bottom Roller: 2 Sets
- Soft Close Damper: 2 Pcs
- Stopper: 2Pcs
- Door Thickness: **18-23mm**

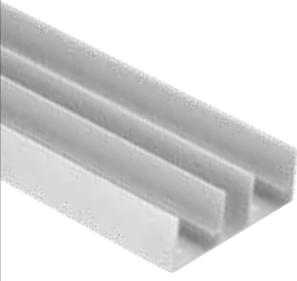
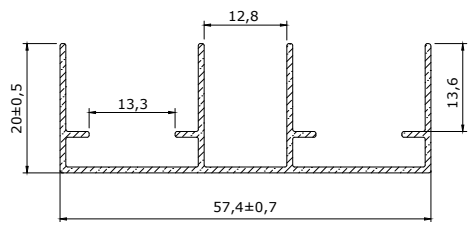

50,000
Cycles Tested

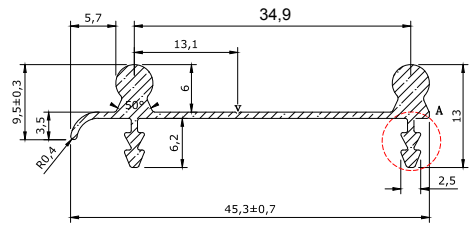
TRACKS OPTIONS FOR BOTTOM GLIDE SYSTEMS

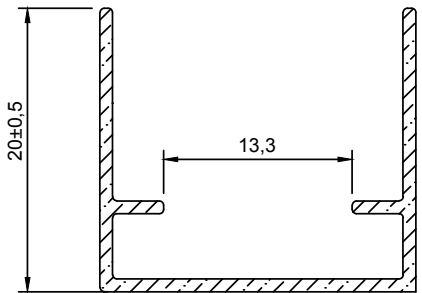
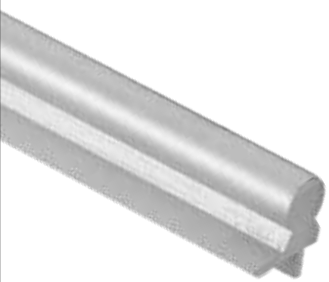
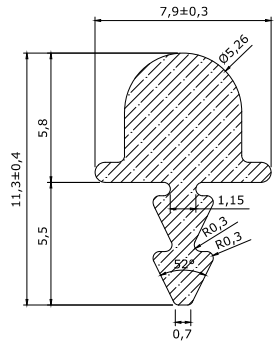
Product Code	Track Options	Drawing						
<table border="1"> <tr> <td>OE.WS.BG1.TT 4mtr AN</td> <td>₹ 1,557</td> </tr> <tr> <td>OE.WS.BG1.TT 3mtr AN</td> <td>₹ 1,177</td> </tr> <tr> <td>OE.WS.BG1.TT 2mtr AN</td> <td>₹ 781</td> </tr> </table> <p>Top Track (separate cover for every length)</p>	OE.WS.BG1.TT 4mtr AN	₹ 1,557	OE.WS.BG1.TT 3mtr AN	₹ 1,177	OE.WS.BG1.TT 2mtr AN	₹ 781		
OE.WS.BG1.TT 4mtr AN	₹ 1,557							
OE.WS.BG1.TT 3mtr AN	₹ 1,177							
OE.WS.BG1.TT 2mtr AN	₹ 781							
<table border="1"> <tr> <td>OE.WS.BG1.BT 4mtr AN</td> <td>₹ 1,557</td> </tr> <tr> <td>OE.WS.BG1.BT 3mtr AN</td> <td>₹ 1,177</td> </tr> <tr> <td>OE.WS.BG1.BT 2mtr AN</td> <td>₹ 781</td> </tr> </table> <p>Bottom Track (separate cover for every length)</p>	OE.WS.BG1.BT 4mtr AN	₹ 1,557	OE.WS.BG1.BT 3mtr AN	₹ 1,177	OE.WS.BG1.BT 2mtr AN	₹ 781		
OE.WS.BG1.BT 4mtr AN	₹ 1,557							
OE.WS.BG1.BT 3mtr AN	₹ 1,177							
OE.WS.BG1.BT 2mtr AN	₹ 781							
<table border="1"> <tr> <td>OE.WS.BG1.S.TT 4mtr AN</td> <td>₹ 902</td> </tr> <tr> <td>OE.WS.BG1.S.TT 3mtr AN</td> <td>₹ 666</td> </tr> <tr> <td>OE.WS.BG1.S.TT 2mtr AN</td> <td>₹ 446</td> </tr> </table> <p>Top Track</p>	OE.WS.BG1.S.TT 4mtr AN	₹ 902	OE.WS.BG1.S.TT 3mtr AN	₹ 666	OE.WS.BG1.S.TT 2mtr AN	₹ 446		
OE.WS.BG1.S.TT 4mtr AN	₹ 902							
OE.WS.BG1.S.TT 3mtr AN	₹ 666							
OE.WS.BG1.S.TT 2mtr AN	₹ 446							
<table border="1"> <tr> <td>OE.WS.BG1.S.BT 4mtr AN</td> <td>₹ 902</td> </tr> <tr> <td>OE.WS.BG1.S.BT 3mtr AN</td> <td>₹ 666</td> </tr> <tr> <td>OE.WS.BG1.S.BT 2mtr AN</td> <td>₹ 446</td> </tr> </table> <p>Bottom Track</p>	OE.WS.BG1.S.BT 4mtr AN	₹ 902	OE.WS.BG1.S.BT 3mtr AN	₹ 666	OE.WS.BG1.S.BT 2mtr AN	₹ 446		
OE.WS.BG1.S.BT 4mtr AN	₹ 902							
OE.WS.BG1.S.BT 3mtr AN	₹ 666							
OE.WS.BG1.S.BT 2mtr AN	₹ 446							

Disclaimer: Product specifications, information & visuals shown in this catalogue are illustrative in nature, the customers are advised to kindly check technical specifications & details before placing order. Company will not be liable for any such loss to customers for technically unsuitable/unfit product. Ozone Overseas reserves the right to change or modify the specifications any time without notice/information. The Company shall only be responsible for defects covered under the product warranty and shall in no way be accountable for any defects (including but not limited to packaging, installation instructions, manuals, specification instructions and care and maintenance instructions), after the delivery of goods to the Customer. All risk and obligations in the goods and products delivered by the Company passes to the Purchaser immediately upon delivery to the Purchaser.

Corporate Office



New Delhi

H-40, Bali Nagar,
New Delhi-110 015
T: +91-11-45576677 (30 Lines)
Fax: +91-11-45576699
e-mail: ozone@ozone-india.com

International Offices



Melbourne, Australia

Ozone Australia Pty. Ltd.
e-mail : info@ozoneaustralia.com.au
website : www.ozoneaustralia.com.au

Works

Ozone Metallics Pvt. Ltd.
Trilokpur Road, Kheri,
Nahan District-Sirmour
Kala Amb
Himachal Pradesh



For Hardware Solutions:

New Delhi*

1/122, Timber Mkt., Kirti Nagar, New Delhi
T : +91-11-49124400, 01
e-mail: delhihub@ozone-india.com

For Security Solutions:

Gurugram*

#548 Udyog Vihar, Phase 5,
Sector 19, Gurugram, Haryana-122016
Ph : +91-124-4961164, 65

Branch Offices

Ahmedabad

407, 4th Floor, Shivalik Abaise,
Opp. Shell Petrol Pump, Prahaladnagar,
Ahmedabad - 380051
T : +91-079-29706789

Jaipur

27, 5th Floor, Mahima Trinity Mall, Swej Farm,
New Sanganer Road, Jaipur-302019
T : +91-141-2294261
e-mail: jaipurhub@ozone-india.com

Bengaluru*

No. 424, 2nd Floor, Above HDFC Bank,
Passport Office Road, 6th block,
Koramangala, Bengaluru - 560034
T: +91-80-41207539
e-mail: blrhub@ozone-india.com

Kolkata

4 Govt Place, 4th floor, Room No:- 4H
Delta House. Kolkatta - 700001
Mob: +91-9831176481, +91-7042080395

Chandigarh

SCO 907, NAC Mani Majra,
Near Solitaire Hotel,
Chandigarh - 160101
Mob: +91-9316001154

Lucknow*

Akash Apartment-2 1st Floor Gokhale Marg
Opp. IFFCO, Lucknow-226001
T : +91-0522-4109647
Mob: +91-7408753777

Chennai*

No.28/1, Rajarathnam Street, Kilpauk,
Opp. Beverly Hotel, Chennai - 600010
T: +91-44-43802063
e-mail: chennaihub@ozone-india.com

Mumbai

The Avenue, 607,
Near Waterstones Hotel, Int. Airport Road,
Marol, Andheri (E), Mumbai - 400059
T : +91-22-28306453
Mob: +91-7045775977

Hyderabad

Unit # 704, 7th Floor, Shangrila Plaza,
Road No. 2, Banjara Hills,
Hyderabad - 500034
Mob: +91-9515157564

Pune

#105, 1st Floor, Suyog Center
Market Yard, Gultekdi, Pune - 411037
Mob: +91-9974180155

Indore

503, B Block, Prakrati Corporate,
Y N Road, Indore - 452001
Mob: +91-9589589902

Surat

201, Luxuria Business Hub, Nr.V.R.Mall,
Surat-Dumas Road, New Magdalla Road,
Surat - 395007
Mob: +91-9724009921

Download Ozone India App



Visit Website

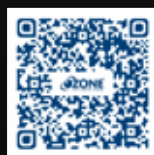

Android



iOS

www.ozone-india.com | India Customer Care: 09310012300 | customercare@ozone-india.com



DIGITAL LOCKS FOR DOOR & FURNITURE



Mobile App



Fingerprint



Password



Emergency
Key



RFID Card

PRICE LIST
W.E.F. 1 APRIL 2021





KEYLESS OPERATING CONVENIENCE

Ozone digital door locks are a perfect fit for the safety & security needs of the digital generation. Equipped with the most advanced security features, they are an invincible choice for main as well as interior doors, of both homes and offices.

Key Features:

- App Based Operation
- Remote Access
- Multiple Access Modes

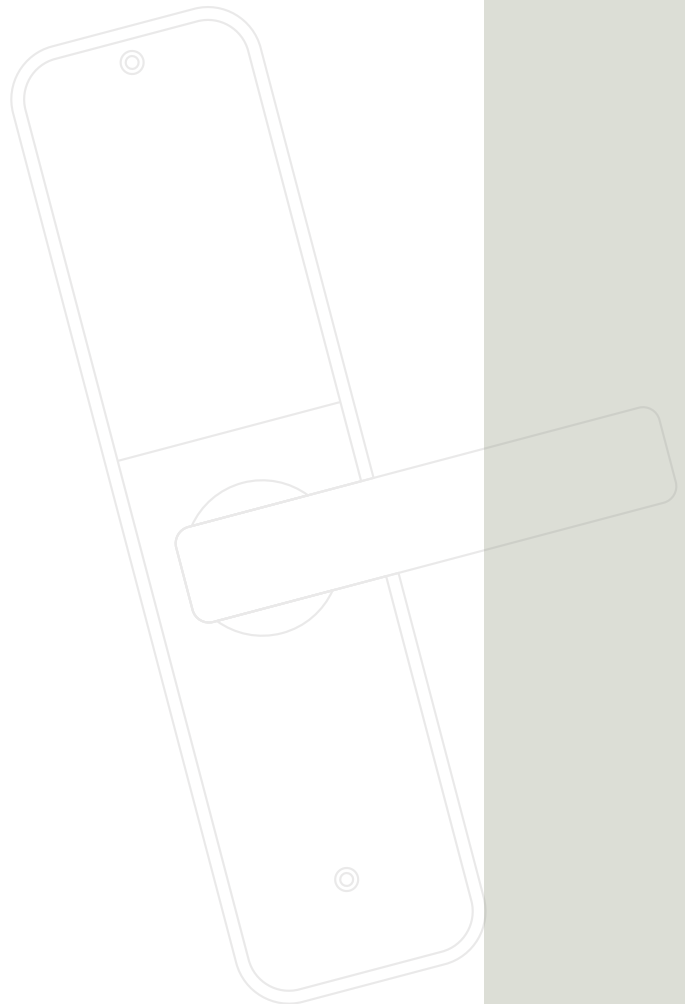

UNLOCK A SMARTER WORLD

PRESENTING DIGITAL DOOR LOCKS BY OZONE

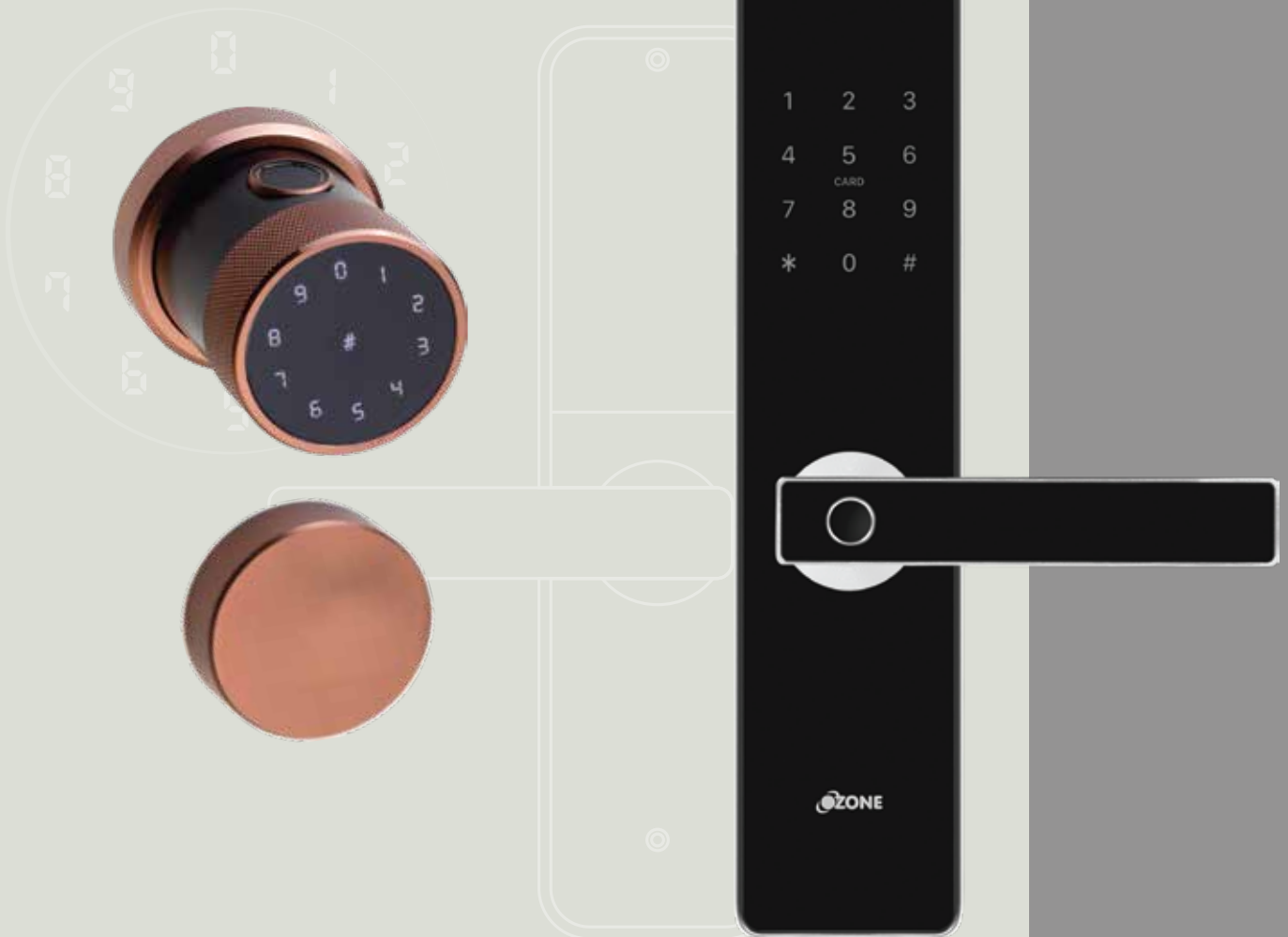

MOBILE APP



FINGERPRINT



RFID CARD



USER PIN CODE



EMERGENCY KEY



MORPHY SERIES

MORPHY BT PLUS
MODEL: OZ-FDL-01-BL STD
FOR WOODEN/ METAL DOORS

MRP ₹ 29,500/-



MOBILE APP



FINGERPRINT



RFID CARD



USER PIN CODE



EMERGENCY KEY

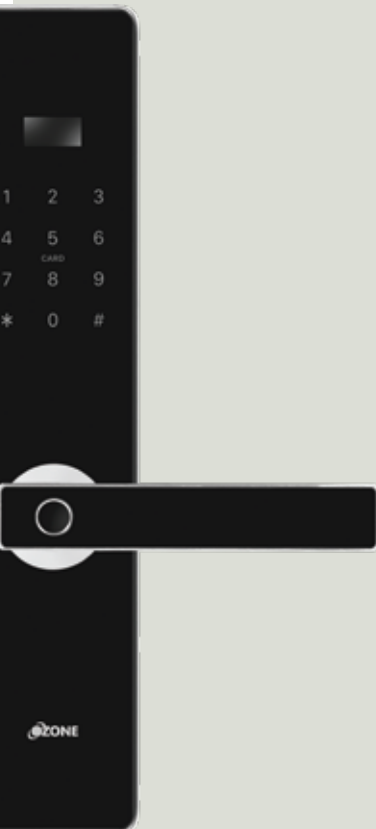

MORPHY PLUS
MODEL: OZ-FDL-01 STD
FOR WOODEN/ METAL DOORS

MRP ₹ 26,500/-



FINGERPRINT



RFID CARD



USER PIN CODE



EMERGENCY KEY



MORPHY BT M
MODEL: OZ-FDL-02 BL STD
FOR WOODEN/ METAL DOORS

MRP ₹ 26,500/-



MOBILE APP



FINGERPRINT



RFID CARD



USER PIN CODE



EMERGENCY KEY



MORPHY M
MODEL: OZ-FDL-02 STD
FOR WOODEN/ METAL DOORS

MRP ₹ 23,500/-



FINGERPRINT



RFID CARD



USER PIN CODE



EMERGENCY KEY



MORPHY BT
MODEL: OZ-FDL-03 BL STD
FOR WOODEN/ METAL DOORS

MRP ₹ 24,900/-



MOBILE APP



FINGERPRINT



RFID CARD



USER PIN CODE



EMERGENCY KEY

MORPHY
MODEL: OZ-FDL-03 STD
FOR WOODEN/ METAL DOORS

MRP ₹ 20,950/-



FINGERPRINT



RFID CARD



USER PIN CODE



EMERGENCY KEY



MORPHY SERIES

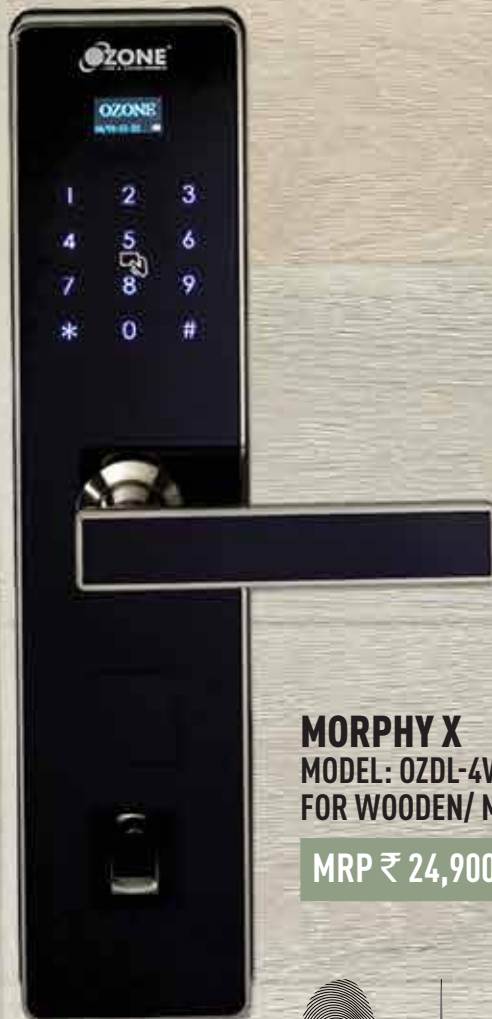

MORPHY X
MODEL: OZDL-4WA STD
FOR WOODEN/ METAL DOORS

MRP ₹ 24,900/-



FINGERPRINT



RFID CARD



USER PIN CODE



EMERGENCY KEY

ORACLE SERIES



MOBILE APP



FINGERPRINT



RFID CARD



USER PIN CODE



EMERGENCY KEY

AVAILABLE:



BRONZE



BLACK



GOLD



**MODEL: OZ-FDL-11-BL
FOR WOODEN/ METAL DOORS**

MRP ₹ 19,990/-



MOBILE APP



FINGERPRINT



RFID CARD



USER PIN CODE



EMERGENCY KEY

AVAILABLE:



BRONZE



BLACK



GOLD



**MODEL: OZ-FDL-11-RBL GOLD
FOR WOODEN/ METAL DOORS**

MRP ₹ 21,950/-



MOBILE APP



FINGERPRINT



RFID CARD



USER PIN CODE

NARROW STYLE FINGERPRINT LOCK SERIES

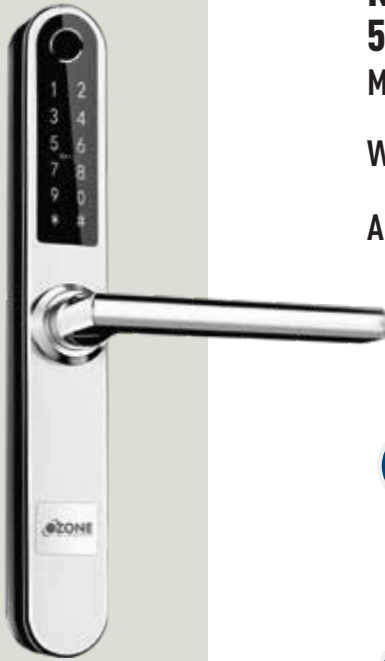

NARROW STYLE FINGERPRINT LOCK 5 IN 1 ACCESS

MODEL: OZ-FDL-33 BL STD

WOODEN DOOR

MRP ₹ 24,950/-

ALUMINIUM DOOR

MRP ₹ 21,350/-



OZ-FDL-33BL 60W SS
(for wooden door)

OZ-FDL-33BL 30AL SS
(for aluminium door)



OZ-FDL-33 BL 60W BM
(for wooden door)

OZ-FDL-33 BL 30AL BM
(for aluminium door)



MOBILE APP



FINGERPRINT



RFID CARD



USER PIN CODE



EMERGENCY KEY

NARROW STYLE FINGERPRINT LOCK 4 IN 1 ACCESS

MODEL: OZ-FDL-33 STD

WOODEN DOOR

MRP ₹ 21,950/-

ALUMINIUM DOOR

MRP ₹ 21,350/-



FINGERPRINT



RFID CARD



USER PIN CODE



EMERGENCY KEY



OZ-FDL-33 60W SS
(for wooden door)

OZ-FDL-33 30AL SS
(for aluminium door)



OZ-FDL-33 60W BM
(for wooden door)

OZ-FDL-33 30AL BM
(for aluminium door)

TRINITY SERIES

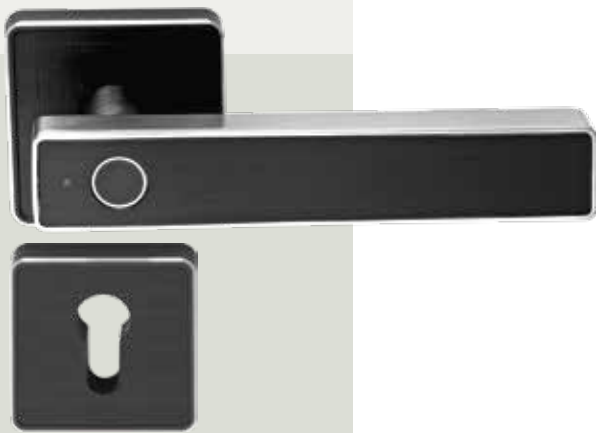

**MODEL: OZ-FDL-22 RBL STD BLACK/SC
FOR WOODEN/ METAL DOORS**

MRP ₹ 18,000/-



MOBILE APP



FINGERPRINT



EMERGENCY KEY

**MODEL: OZ-FDL-22 BL STD BLACK/SC
FOR WOODEN/ METAL DOORS**

MRP ₹ 15,900/-



MOBILE APP



FINGERPRINT



EMERGENCY KEY





DIGITAL GLASS DOOR LOCK

NO
Glass Cutout
Required



FINGERPRINT



RFID CARD



USER PIN CODE



*REMOTE CONTROL
(OPTIONAL)

**MODEL: OZDL-23PCF-G2G STD
GLASS TO GLASS**

MRP ₹ 28,820/-

**MODEL: OZDL-23PCF-G2W STD
GLASS TO WALL**

MRP ₹ 25,630/-

DIGITAL RIM LOCK



MASTER PIN CODE



RFID CARD



EMERGENCY KEY

SUITABLE FOR WOODEN INTERNAL DOOR LOCKS
MODEL: OZDL-11 KCP STD

MRP ₹ 17,999/-

SUITABLE FOR WOODEN INTERNAL DOOR LOCKS
MODEL: OZDL-11 FP STD

MRP ₹ 18,999/-



MASTER PIN CODE



FINGERPRINT



DIGITAL RIM LOCK



SUITABLE FOR WOODEN INTERNAL DOOR LOCKS
MODEL: OZDL-11 RF STD

MRP ₹ 15,999/-



MASTER PIN CODE



RFID CARD

SUITABLE FOR WOODEN INTERNAL
SLIDING DOOR

MODEL: OZDL-11 RF-SL STD

MRP ₹ 15,999/-



MASTER PIN CODE



RFID CARD





PAD LOCK SERIES



MOBILE APP



RFID CARD

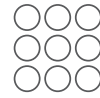

USER PIN CODE



EMERGENCY KEY

MODEL: OZ-DPL-22 BL BLACK

MRP ₹ 14,000/-



FINGERPRINT



EMERGENCY KEY

MODEL: OZ-FPL-11-BLACK

MRP ₹ 6,650/-

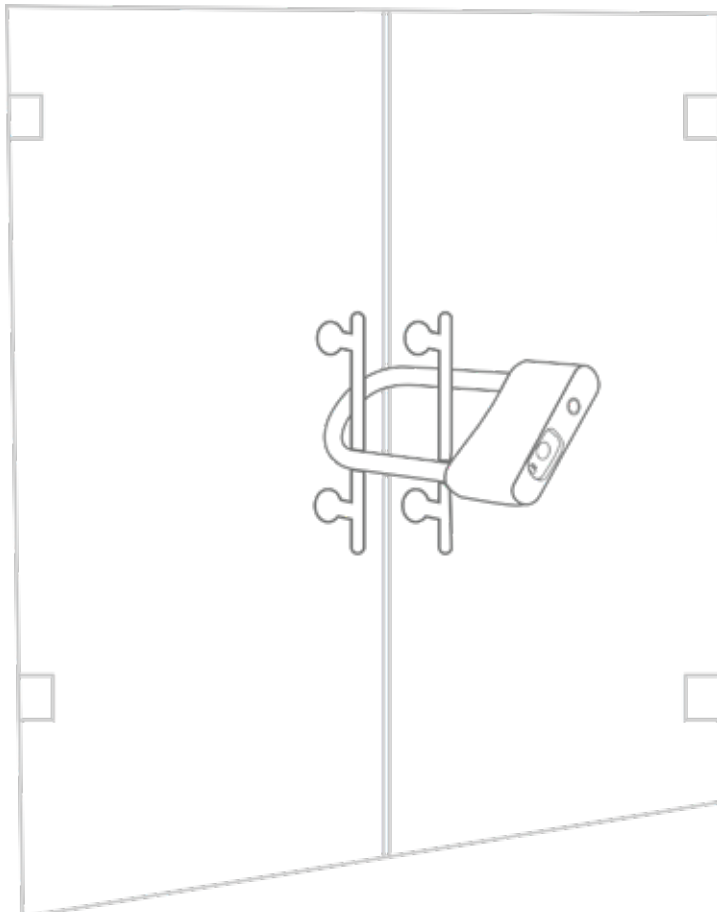

DIGITAL FURNITURE LOCKS

A KEYLESS WAY TO SECURE YOUR VALUABLES

With Ozone's furniture locks, you won't have to worry about keeping your valuables safe and secure, anymore. These new age digital locks provide a keyless solution for your home and your office. These locks can easily fit into different types of furniture include wooden and metal furniture.



PASSWORD & KEY LOCK

FOR METAL CABINETS



MASTER PIN CODE



USER PIN CODE



EMERGENCY KEY

MODEL: OZFL-301V-PK

MRP ₹ 2,690/-

PASSWORD & KEY LOCK



MODEL: OZFL-301H-PK

MRP ₹ 2,690/-



MASTER PIN CODE



USER PIN CODE



EMERGENCY KEY



FINGERPRINT & KEY LOCK



FINGERPRINT



EMERGENCY KEY

MODEL: OZFL-302-FK

MRP ₹ 4,590/-

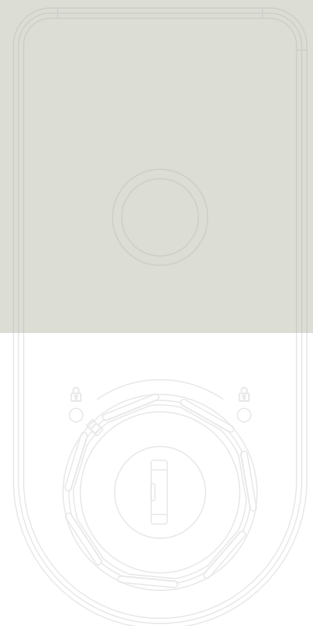



PASSWORD & FINGERPRINT LOCK



FINGERPRINT



MASTER PIN CODE



USER PIN CODE

MODEL: OZFL-203-PF

MRP ₹ 5,690/-



PASSWORD LOCK



MODEL: OZFL-201-PW

MRP ₹ 2,990/-



MASTER PIN CODE



USER PIN CODE

RFID CARD LOCK



RFID CARD

MODEL: OZFL-202-RF

MRP ₹ 2,790/-



CONTACT HERE

PASSWORD LOCK

FOR METAL/WOODEN CABINETS & DRAWERS



MASTER PIN CODE



USER PIN CODE



EMERGENCY KEY

MODEL: OZFL-101-PK

MRP ₹ 3,990/-

PASSWORD LOCK



MODEL: OZFL-601-PW

MRP ₹ 3,590/-



USER PIN CODE

PASSWORD LOCK



FOR SINGLE OR MULTIPLE
METAL/WOODEN
DRAWERS CABINETS

MODEL: OZFL-401-PW

MRP ₹ 2,990/-



MASTER PIN CODE

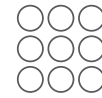

USER PIN CODE



FINGERPRINT LOCK

MODEL: OZFL-402-F

MRP ₹ 4,690/-



FINGERPRINT

FINGERPRINT LOCK



FOR WOODEN
CABINETS & DRAWERS



FINGERPRINT

MODEL: OZFL-55F

MRP ₹ 4,450/-

PASSWORD & FINGERPRINT LOCK



MODEL: OZFL-66V-PF (VERTICAL)

MRP ₹ 4,850/-



FINGERPRINT



USER PIN CODE

MODEL: OZFL-66H-PF (HORIZONTAL)

MRP ₹ 4,850/-

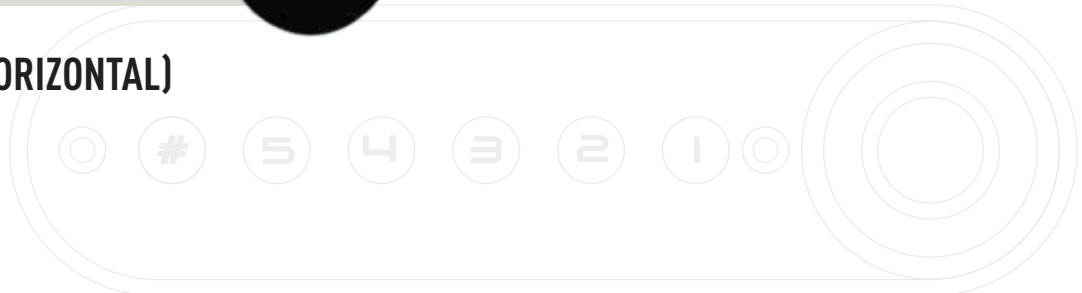

PASSWORD LOCK

MODEL: OZFL-88 P BLACK

MRP ₹ 1,990/-



USER PIN CODE

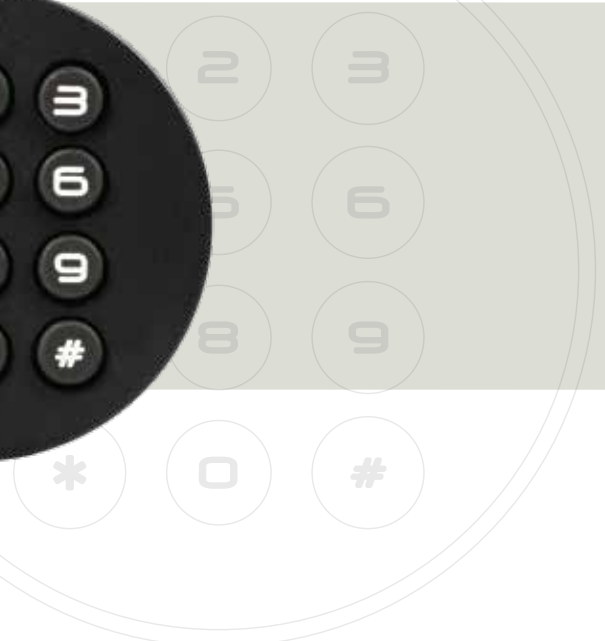

PASSWORD & FINGERPRINT LOCK

FOR METAL WARDROBES



MODEL: OZFL-501-PF

MRP ₹ 7,990/-



FINGERPRINT



MASTER PIN CODE



USER PIN CODE

PASSWORD LOCK

MODEL: OZFL-502-PW

MRP ₹ 4,990/-



MASTER PIN CODE



USER PIN CODE



OPTIONAL ACCESSORIES



RFID CARD
OZEL-RF222/333-Card V10 White

MRP ₹ 130/-



RFID CARD
OZDL-RF CARD ACC.

MRP ₹ 500/-



GLASS DOOR LOCK REMOTE
OZDL-23 RC-GL ACC

MRP ₹ 3,150/-



GATEWAY
OZ-GATEWAY-11

MRP ₹ 5,300/-



Ozone Secutech Pvt. Ltd. Registered Office: H 40, Bali Nagar, New Delhi - 110015, India
Operations Office: Plot No. 548, Phase V, Udyog Vihar , Gurugram, Haryana - 122016, India
Visit: www.ozonesecutech.com | Email: ccsafes@ozone-india.com India | Customer Care: +91-11-45576666

DIGITAL LOCKS FOR DOOR & FURNITURE



-  MOBILE APP
-  FINGERPRINT
-  RFID CARD
-  USER PIN CODE
-  EMERGENCY KEY

PRICE LIST (MRP)
W.E.F. 1 APRIL 2021



DIGITAL SAFES

FOR HOMES, OFFICES & COMMERCIAL SPACES



ABOUT US

Established in 1999, Ozone has a global presence across 15 countries, 4 R&D centers across Israel, Korea, China & India, and 4 state-of-the-art factories in India & China. Ozone Secutech is a professional safety and security solution provider having its own design center, manufacturing, sales & service setup.

Using the latest techniques blended with cutting edge technology, we are constantly developing innovative solutions that improve our customers' lives through greater security, safety and convenience. We offer complete range of safety & security products and solutions for institutional, commercial and consumer markets.

We offer a comprehensive range of choices in usability and design. Our range of Digital Safes include Biometric (fingerprint) enabled, PIN/password enabled, fire resistant, water resistant, moisture resistant & chemical resistant safes. We also make connected safes equipped with state-of-the-art burglary resistant GSM module - 'Notify'.

All our products go through stringent quality checks and are designed for durability, reliability and high performance.



FIRE WARRIOR-1700

Size (mm) : (H) 1700 x (W) 800 x (D) 630
 Size (inch) : (H) 66.93 x (W) 31.50 x (D) 24.80
 Weight (Kg.) : 525 (Approx.)
 Volume (Ltr.) : 417
 Accessories: 3 Adjustable Shelf &
 1 Drawer Inside

MRP: ₹ **1,59,990/-**



FIRE WARRIOR-1200

Size (mm) : (H) 1200 x (W) 700 x (D) 635
 Size (inch) : (H) 47 x (W) 27 x (D) 25
 Weight (Kg.) : 270 (Approx.)
 Volume (Ltr.) : 230
 Accessories : 2 Adjustable Shelf &
 1 Drawer Inside

MRP: ₹ **97,990/-**



FIRE WARRIOR-99

Size (mm) : (H) 985 x (W) 600 x (D) 570
 Size (inch) : (H) 38.78 x (W) 23.62 x (D) 22.44
 Weight (Kg.) : 185 (Approx.)
 Volume (Ltr.) : 145
 Accessories: 1 Adjustable Shelf &
 1 Drawer Inside

MRP: ₹ **89,990/-**



FIRE WARRIOR-77

Size (mm) : (H) 760 x (W) 500 x (D) 490
 Size (inch) : (H) 29.92 x (W) 19.69 x (D) 19.29
 Weight (Kg.) : 110 (Approx.)
 Volume (Ltr.) : 67
 Accessories: 1 Adjustable Shelf &
 1 Drawer Inside

MRP: ₹ **59,690/-**



FIRE WARRIOR-55

Size (mm) : (H) 595 x (W) 460 x (D) 470
 Size (inch) : (H) 23.43 x (W) 18.11 x (D) 18.50
 Weight (Kg.) : 80 (Approx.)
 Volume (Ltr.) : 40
 Accessories: 1 Adjustable Shelf

MRP: ₹ **45,990/-**



Fireproof



Tested



Anti-theft
Alarm



Dual Combination
Access

APPLICATIONS:



Home



Office



Warehouse



FIRE WARRIOR-11

Size (mm) : (H) 385 x (W) 496 x (D) 390
 Size (inch) : (H) 15.16 x (W) 19.53 x (D) 15.35
 Weight (Kg.) : 47 (Approx.)
 Volume (Ltr.) : 19
 Accessories : 1 Tray inside

MRP: ₹ **33,590/-**



Fireproof



Tested



Anti-theft
Alarm



Dual Combination
Access

APPLICATIONS:



Home



Office



Warehouse

KEY FEATURES

- Special fireproof material (cellulose concrete) ensures the inner temperature remains less than 118°C, while exposed in 1030°C flame for one hour
- User Access: Dual combination of 4 to 8 digits User PIN code & Manual key
- Emergency override key
- Strong Steel shooting Bolts
- Low battery indicator
- External battery power input option available
- UL fire rated

FIRE WARRIOR SAFES WITH NOTIFY™



FIRE WARRIOR-99 N SERIES

Size (mm) : (H) 920 x (W) 600 x (D) 570
 Size (inch) : (H) 36.22 x (W) 23.62 x (D) 22.44
 Weight (Kg.) : 185 (Approx.)
 Volume Ltr. : 145
 Accessories : 1 Adjustable Shelf &
 1 Drawer Inside

MRP: ₹ **1,09,990/-**



FIRE WARRIOR-77 N SERIES

Size (mm) : (H) 760 x (W) 500 x (D) 490
 Size (inch) : (H) 29.92 x (W) 19.69 x (D) 19.29
 Weight (Kg.) : 110 (Approx.)
 Volume (Ltr.) : 67
 Accessories : 1 Adjustable Shelf &
 1 Drawer Inside

MRP: ₹ **79,690 /-**

KEY FEATURES

- Notify module inside the safe for extra safety
- SMS Alert to upto 7 predefined mobile numbers
- Special fireproof material (cellulose concrete) ensures the inner temperature remains less than 118°C, while exposed in 1030°C flame for one hour
- User Access: Combination of User PIN & Manual key
- Emergency override key
- Strong Steel shooting Bolts
- Unique Notify GSM module
- Vibration sensor to detect break-in/tempering
- Wireless Hooter that can be placed away from the Safe



Wireless Hooter



SMS Alert



Fireproof



Tested



Anti-theft
Alarm



Dual Combination
Access

APPLICATIONS:



Home



Office



Warehouse



FIRE WARRIOR-22

Size (mm) : (H) 350 x (W) 495 x (D) 390
 Size (inch) : (H) 13.78 x (W) 19.49 x (D) 15.35
 Weight (Kg.) : 46 (Approx.)
 Volume (Ltr.) : 19
 Accessories : 1 Tray inside

MRP: ₹ **33,590/-**



FIRE WARRIOR-66

Size (mm) : (H) 530 x (W) 460 x (D) 470
 Size (inch) : (H) 20.87 x (W) 18.11 x (D) 18.50
 Weight (Kg.) : 74 (Approx.)
 Volume (Ltr.) : 39
 Accessories : 1 Adjustable Shelf

MRP: ₹ **45,990/-**

KEY FEATURES

- Special fireproof material (cellulose concrete) ensures the inner temperature remains less than 118°C, while exposed in 1030°C flame for one hour
- User Access: Dual combination of 4 to 8 digits User PIN code & Manual Key
- Emergency override Key
- Strong Steel shooting Bolts
- The last 50 opening records can be tracked
- Low battery indicator
- External battery power input option available
- UL fire rated



Fire Resistant



Dual Combination Access



LED Display



Tested



OES-FGP-FP-11

Size (mm) : (H) 370 x (W) 485 x (D) 430
 Size (inch) : (H) 14.57 x (W) 19.09 x (D) 16.93
 Weight (Kg.) : 52 (Approx.)
 Volume (Ltr.) : 19.50
 Accessories : 1 Tray inside

MRP: ₹ **38,490/-**



OES-MD-77 Silver

Size (mm) : (H) 910 x (W) 500 x (D) 450
 Size (inch) : (H) 35.83 x (W) 19.69 x (D) 17.72
 Weight (Kg.) : 120 (Approx.)
 Volume (Ltr.) : 112.50

MRP: ₹ **47,990/-**

KEY FEATURES

- User Access: Upto 10 fingerprint and 4 to 30 digits user PIN code can be registered
- Dual combination of lock system with built-in cylinder key
- LED display with backlight and keypad audio
- 2 locking bolts & 2 dead bolt
- Low battery Indicator



Fireproof



Fingerprint with User Code Access

KEY FEATURES

- Electronic locking system
- User Access: Upto 3 to 6 user PIN code & Master PIN code
- Auto Secure mode alarm on consecutive 3 wrong PIN attempts or tempering resulting into keypad inactivity for 1 minutes
- Emergency override key
- Strong steel body
- Low Battery Indicator
- Extra battery backup option



Dual Combination Access



User Code Access



Auto Secure

APPLICATIONS:



Retail



Petrol Pump



Temple



SAFILO DIGITAL-1

Size (mm) : (H) 420 x (W) 350 x (D) 360
 Size (inch) : (H) 16.54 x (W) 13.78 x (D) 14.17
 Weight (Kg.) : 20 (Approx.)
 Volume (Ltr.) : 40

MRP: ₹ **13,990/-**

KEY FEATURES

- Electronic locking system
- User Access: 3 to 6 digit User PIN code
- Master PIN code available
- Emergency override key
- Low battery indicator
- External battery power input option available



User PIN Code Access



Auto Secure



LED Display

APPLICATIONS:



Home



Office



Retail



SAFILO BIO-X

Size (mm) : (H) 350 x (W) 400 x (D) 350
 Size (inch) : (H) 13.78 x (W) 15.74 x (D) 13.78
 Weight (Kg.) : 21.30 (Approx.)
 Volume (Ltr.) : 40.80

MRP: ₹ **16,790/-**

KEY FEATURES

- Electronic locking system
- User Access: Combination of fingerprint + User PIN code, only 3-8 digits PIN code, only fingerprint
- Auto secure mode on 3 consecutive wrong PIN attempts resulting into 20 seconds beep sound
- Emergency override key
- Register upto 29 fingerprints
- External battery power input option available
- Accessories : 1 shelf inside



Combination of Fingerprint & PIN



User PIN Code Access



LED Display



Auto Secure



Touch Screen Panel

APPLICATIONS:



Home



Office



Retail



Logistic



SAFILO BIO-2

Size (mm) : (H) 555 x (W) 350 x (D) 360
 Size (inch) : (H) 21.85 x (W) 13.78 x (D) 14.17
 Weight (Kg.) : 24.70 (Approx.)
 Volume (Ltr.) : 55

MRP: ₹ **18,990/-**



JADE BLACK 01

Size (mm) : (H) 200 x (W) 350 x (D) 200
 Size (inch) : (H) 7.87 x (W) 13.78 x (D) 7.87
 Weight (Kg.) : 6.40 (Approx.)
 Volume (Ltr.) : 9.80

MRP: ₹ **8,990/-**



JADE BLACK

Size (mm) : (H) 200 x (W) 435 x (D) 365
 Size (inch) : (H) 7.87 x (W) 17.13 x (D) 14.37
 Weight (Kg.) : 12.60 (Approx.)
 Volume (Ltr.) : 26

MRP: ₹ **12,990/-**



ACCESSORY

CONVENIO DIGITAL-33 ACC

Hand Held Device for
CONVENIO-33 Std.

(Activity record of last 100 openings)

MRP: ₹ **21,500/-**

KEY FEATURES

- Electronic locking system
- User Access : RFID card, 4 to 6 digits user PIN code
- Auto secure mode on 3 consecutive wrong PIN attempts resulting into keypad inactivity for 5 minutes
- Emergency override key
- Records for 400 openings
- Master PIN code available
- Low battery indicator
- External battery backup option with USB cable



RFID Card Access



LED Display



User PIN Code Access



Auto Secure

APPLICATIONS:



Home



Hotel



Office



Retail



OTD-404 BLACK

Size (mm) : (H) 350 x (W) 450 x (D) 355
 Size (inch) : (H) 13.78 (W) 17.72 x (D) 13.98
 Weight (Kg.) : 20.50 (Approx.)
 Volume (Ltr.) : 45

MRP: ₹ **13,990/-**



User PIN Code Access



Auto Secure



LCD Display

KEY FEATURES

- Electronic locking system
- User Access: 4 to 8 digits user PIN code
- Auto secure mode on 3 consecutive wrong PIN attempts resulting into keypad inactivity keypad for 5 minutes
- LED display with backlit touch screen
- Extra battery backup option

APPLICATIONS:



Home



Office



Retail



OES-17 EN BLUE

Size (mm) : (H) 170 x (W) 230 x (D) 170
 Size (inch) : (H) 6.69 x (W) 9.06 x (D) 6.69
 Weight (Kg.) : 4 (Approx.)
 Volume (Ltr.) : 4.50

MRP: ₹ **4,990/-**



User Code Access



Emergency Override Key



LED Display

KEY FEATURES

- Electronic locking system
- User access: 3 to 8 digits user PIN code
- 3 minutes auto secure/freeze mode on 3 consecutive wrong PIN attempts
- Low battery buzzer alarm
- Emergency override key

APPLICATIONS:



Home



Office



O-SQUIRE

Size (mm) : (H) 200 x (W) 350 x (D) 200
 Size (inch) : (H) 7.87 x (W) 13.78 x (D) 7.87
 Weight (Kg.) : 6.20 (Approx.)
 Volume (Ltr.) : 9

MRP: ₹ **7,590/-**



User PIN Code
Access



Auto Secure



LED Display

KEY FEATURES

- Electronic locking system
- User Access : 3 to 6 digits user PIN code
- Auto secure mode on 4 consecutive wrong PIN attempts resulting into keypad inactivity for 15 minutes
- LED Display
- Emergency override key
- Low battery indicator
- Battery power input option available



O-LAPTOP

Size (mm) : (H) 200 x (W) 430 x (D) 380
 Size (inch) : (H) 7.87 x (W) 16.93 x (D) 14.96
 Weight (Kg.) : 11 (Approx.)
 Volume (Ltr.) : 24.50

MRP: ₹ **9,990/-**



User PIN Code
Access



Auto Secure



LED Display

KEY FEATURES

- Electronic locking system
- User Access : 3 to 6 digit user PIN code
- Auto secure mode on 3 consecutive wrong PIN attempts resulting into keypad inactivity for 15 minutes
- LED Display
- Emergency override key
- Low battery indicator



OPAL IVORY

Size (mm) : (H) 250 x (W) 350x (D) 250
 Size (inch) : (H) 9.84 x (W) 13.78 x (D) 9.84
 Weight (Kg.) : 11 (Approx.)
 Volume (Ltr.) : 16.50

MRP: ₹ **9,990/-**



User PIN Code
Access



Auto
Secure



LED
Display

KEY FEATURES

- Electronic locking system
- User Access : 4 to 6 digits user PIN code
- Auto secure mode on 3 consecutive wrong PIN attempts
- Emergency override key
- Dual mode : Personal/Hotel mode
- Master PIN code available
- Low battery indicator
- Extra battery backup option



AGATE LAPTOP

Size (mm) : (H) 200 x (W) 430 x (D) 380
 Size (inch) : (H) 7.87 x (W) 16.93 x (D) 14.96
 Weight (Kg.) : 10.70 (Approx.)
 Volume (Ltr.) : 24.50

MRP: ₹ **7,590/-**



User PIN Code
Access



Auto Secure

KEY FEATURES

- Electronic locking system
- User Access : 3 to 8 digits User PIN code
- Auto secure mode on 3 consecutive wrong PIN attempts
- Emergency override key
- Extra battery backup option



TUSKER-11

Size (mm) : (H) 250 x (W) 350 x (D) 250
 Size (inch) : (H) 9.84 x (W) 13.78 x (D) 9.84
 Weight (Kg.) : 9.50 (Approx.)
 Volume (Ltr.) : 16

MRP: ₹ **7,990/-**



User Code Access



Emergency Override Key



LED Display

KEY FEATURES

- Electronic locking system
- User access : 4 to 8 digits user PIN code
- Emergency override key
- Low battery indicator with Audio/Visual alarm
- Master PIN code available
- Extra battery backup option

APPLICATIONS:



Home



Office



Retail



OES-17 EN Grey

Size (mm) : (H) 170 x (W) 230 x (D) 170
 Size (inch) : (H) 6.69 x (W) 9.06 x (D) 6.69
 Weight (Kg.) : 4 (Approx.)
 Volume (Ltr.) : 4.50

MRP: ₹ **4,990/-**

Available : Yellow & Blue Color



User Code Access



Emergency Override Key



LED Display

KEY FEATURES

- Electronic locking system
- User access: 3 to 8 digits user PIN code
- 3 minutes auto secure/freeze mode on 3 consecutive wrong PIN attempts
- Low battery buzzer alarm
- Emergency override key

APPLICATIONS:



Home



Office



OES-BAS-i10

Size (mm) : (H) 200 x (W) 300 x (D) 200
 Size (inch) : (H) 7.87 x (W) 11.81 x (D) 7.87
 Weight (Kg.) : 6 (Approx.)
 Volume (Ltr.) : 7.80

MRP: ₹ **5,690/-**



User Code Access



Emergency Override Key



LED Display

KEY FEATURES

- Electronic locking system
- User access: 3 to 8 digits user PIN code
- 3 minutes auto secure/freeze mode on 3 consecutive wrong PIN attempts
- Low battery buzzer alarm
- Emergency override key

APPLICATIONS:



Home



Office



ES-ECO-BB-77-GREY

Size (mm) : (H) 650 x (W) 440 x (D) 405
 Size (inch) : (H) 25.59 x (W) 17.32 x (D) 15.94
 Weight (Kg.) : 34.70 (Approx.)
 Volume (Ltr.) : 95.40
 Accessories : 2 Shelf Inside

MRP: ₹ **21,790/-**



User Code Access



Emergency Override Key



LED Display

KEY FEATURES

- Electronic Locking System
- User access : 4 to 8 digits user PIN code
- Emergency override key
- Low battery indicator with Audio/Visual alarm
- Master PIN code available



CONVENIO MANUAL-11

Size (mm) : (H) 250 x (W) 350 x (D) 250
 Size (inch) : (H) 9.84 x (W) 13.78 x (D) 7.87
 Weight (Kg.) : 9 (Approx.)
 Volume (Ltr.) : 15.50

MRP: ₹ **6,790/-**



Manual Key

KEY FEATURES

- Manual locking system
- Strong steel body
- Single user access
- Ideal for Wardrobe/Cupboard

APPLICATIONS:



Home



Office



Retail



CONVENIO MANUAL - 12

Size (mm) : (H) 555 x (W) 350 x (D) 360
 Size (inch) : (H) 21.85 x (W) 13.78 x (D) 14.17
 Weight (Kg.) : 24.70 (Approx.)
 Volume (Ltr.) : 55

MRP: ₹ **19,990/-**



Dual Combination Access



Manual Key

KEY FEATURES

- Manual locking system
- Strong steel body construction and powder-coated finish
- Dual combination key system
- SS Shooting Bolts
- Ideal for office/warehouse & Commercial areas

APPLICATIONS:



Home



Office



Retail



Logistic



CONVENIO MANUAL - DD 13

Size (mm) : (H) 700 x (W) 460 x (D) 460
 Size (inch) : (H) 27.56 x (W) 18.11 x (D) 18.11
 Weight (Kg.) : 45 (Approx.)
 Volume (Ltr.) : 92

MRP: ₹ **19,990/-**



Manual Key

KEY FEATURES

- Manual locking system
- Strong multi-band construction
- 6 lever lock
- Two tone powder coated finish
- Cash drop drawer: 2,000 qty. notes bundles

APPLICATIONS:



Retail



Blue for corrosive liquids

Yellow for flammable liquids

Red for combustible liquids

OZ-ISC-SCD 410 Ltr Red

Size (mm) : (H) 1650 x (W) 1500 x (D) 860
 Size (inch) : (H) 64.96 x (W) 59.06 x (D) 33.86
 Weight (Kg.) : 270 (Approx.)
 Volume (Ltr.) : 410
 Adjustable Shelves (Pcs) : 2
 Shelves Capacity (Kg) : 100
 Door Type : Double Door

MRP: ₹ **1,89,990/-**

Complies with US OSHA 29 CFR 1910.106 and NFPA Code 30, section 4.3.3

KEY FEATURES

- Sturdy 1mm double-wall steel with 38mm of insulating air space
- Self-latching doors
- Fully welded and riveted construction
- Continuous piano hinge provides smooth closure
- Dual vents with built-in flash arresters placed at bottom & opposite top
- Safety shelves designed to handle incidental spills to back & bottom of leak proof sump

APPLICATIONS:



Available Sizes*

HxWxD (mm)	560x430x430	890x590x460	1650x590x460	1120x1090x460	1650x1090x460	1650x860x860	1650x1090x860	1650x1500x860
Capacity (Ltr)	15	45	83	114	170	227	340	410
Weight (Kg.)	35	56	85	100	138	165	190	270
Adjustable Shelves (Pcs)	1	1	2	1	2	2	2	2
Shelves capacity (Kg)	50	50	50	100	100	100	100	100
Door Type	Single Door	Single Door	Single Door	Double Door	Double Door	Double Door	Double Door	Double Door
Cabinet for Flammable liquids - item code	OZ-ISC-15 Ltr Yellow	OZ-ISC-45 Ltr Yellow	OZ-ISC-83 Ltr Yellow	OZ-ISC-114 Ltr Yellow	OZ-ISC-170 Ltr Yellow	OZ-ISC-227 Ltr Yellow	OZ-ISC-340 Ltr Yellow	OZ-ISC-410 Ltr Yellow
Cabinet for Combustible liquids - item code	OZ-ISC-15 Ltr Red	OZ-ISC-45 Ltr Red	OZ-ISC-83 Ltr Red	OZ-ISC-114 Ltr Red	OZ-ISC-170 Ltr Red	OZ-ISC-227 Ltr Red	OZ-ISC-340 Ltr Red	OZ-ISC-410 Ltr Red
Cabinet for Corrosive liquids - item code	OZ-ISC-15 Ltr Blue	OZ-ISC-45 Ltr Blue	OZ-ISC-83 Ltr Blue	OZ-ISC-114 Ltr Blue	OZ-ISC-170 Ltr Blue	OZ-ISC-227 Ltr Blue	OZ-ISC-340 Ltr Blue	OZ-ISC-410 Ltr Blue
MRP/Unit	₹ 46,990/-	₹ 64,990/-	₹ 79,990/-	₹ 89,990/-	₹ 1,29,990/-	₹ 1,49,990/-	₹ 1,59,990/-	₹ 1,89,990/-

*Applicable for Hazard Storage Lockers

Corporate Office:

 **New Delhi**
H-40, Bali Nagar,
New Delhi - 110015
T: +91-11-45576677 (30 Lines)
Fax: +91-11-45576699
E-mail: ozone@ozone-india.com

Operations:

New Delhi
1/122, Timber Market,
Kirti Nagar, New Delhi - 110015

Gurugram
Plot No. 548, Phase V, Udyog Vihar
Gurugram, Haryana - 122016

Works:

Ozone Secutech Pvt. Ltd.
Trilokpur Road, Kheri,
Nahan District-Sirmour
Kala Amb - 173030
Himachal Pradesh

Branch Offices:

Ahmedabad
407, 4th Floor, Shivalik Ahaise,
Opp. Shell Petrol Pump,
Prahaldnagar, Ahmedabad-380051

Mumbai
The Avenue, 607, Near
Waterstones Hotel, Int. Airport Road,
Marol, Andheri (E), Mumbai-400059

Indore
503, B Block, Prakrati Corporate,
Y N Road, Indore - 452001

Chandigarh
SCO 907, NAC Mani Majra
Near Solitaire Hotel,
Chandigarh - 160101

Hyderabad
#8-3-231/4/7, Flat No-103, Laxmi Plaza,
Jubilee Hills, Hyderabad - 500045
Mob: +91-9515156404

International Office:

 **Melbourne, Australia**
Ozone Australia Pty. Ltd.
e-mail : info@ozoneaustralia.com.au
website : www.ozoneaustralia.com.au



New Delhi
1/122, Timber Market,
Kirti Nagar, New Delhi - 110015

Bengaluru

No. 424, 2nd Floor, Above HDFC Bank,
Passport Office Road, 6th block ,
Koramangala, Bengaluru - 560034

Chennai

No.28/1, Rajarathnam Street, Kilpauk,
Opp. Beverly Hotel, Chennai-600010

Jaipur

27, 5th Floor, Mahima Trinity Mall,
Sweej Farm, New Sanganer Road,
Jaipur-302019

Pune

#105, 1st Floor, Swayo Center
Market Yard, Gultekda, Pune - 411037
Mob: +91-9974180155

Kolkata

4 Govt Place, 4th floor, Room No:- 4H
Delta House. Kolkatta - 700001
Mob: +91-9831176481



Ozone Secutech Pvt. Ltd.

Visit : www.ozonesafes.com | Email : ccsafes@ozone-india.com
India Customer Care : +91 9716500300